

Katalog Catalogue

**Präzisionswerkzeuge in Vollhartmetall und Diamant zum
Bohren – Senken – Reiben – Fräsen**
*Precision tools in solid carbide and diamond for
drilling – countersinking – reaming – milling*



HAM Superdrill
Vollhartmetall-Hochleistungsbohrer
für höchste Ansprüche

HAM Superdrill
*solid carbide high performance drills
for highest demands*



HAM Tieflochbohrer
Die neue Generation der extra langen
Vollhartmetall-Spiralbohrer bis 40 x D

HAM Deep hole drills
*the new generation of extra large
solid carbide drills up to 40 x D*



HAM Reibahlen
Hochpräzise Reibwerkzeuge
aus Vollhartmetall

HAM Reamers
*highly precise reamers
in solid carbide*



HAM Schaftfräser
Vollhartmetall-Hochleistungsfräser
für höchste Ansprüche

HAM End mills
*solid carbide high performance
end mills for highest demands*



HAM Radiusfräser
für die 3-D Bearbeitung
von Konturen

HAM Ball nose end mills
*for 3-D machining of
contours*



HAM Torusfräser
für die 3-D Bearbeitung
von Konturen

HAM Toric end mills
*for 3-D machining of
contours*



HAM Ihr zuverlässiger Partner weltweit ...
HAM Your reliable partner worldwide ...



... besuchen Sie unsere Homepage www.ham-tools.com
... visit our website



HAM Bohr-, Senk- und Reibwerkzeuge

- 4 Übersicht
- 13 Vollhartmetall-Spiralbohrer
- 23 Vollhartmetallbohrer Superdrill
- 35 Vollhartmetallbohrer Nirodrill
- 43 Vollhartmetall-Tieflochbohrer
- 61 Vollhartmetall-Spezialbohrer
- 67 Vollhartmetall-Reibahlen
- 153 Schnittdaten Bohren
- 238 Piktogramm-Übersicht
- 240 Anfrageformular für Sonderwerkzeuge
- 244 HAM Produktlinien

HAM drilling, countersinking and reaming tools

- 4 *program*
- 13 *solid carbide spiral drills*
- 23 *solid carbide Superdrill*
- 35 *solid carbide Nirodrill*
- 43 *solid carbide deep hole drills*
- 61 *solid carbide special drills*
- 67 *solid carbide reamers*
- 153 *cutting data drilling*
- 238 *overview of pictograms*
- 240 *inquiry form for special tools*
- 244 *HAM product lines*





















HAM Fräswerkzeuge

- 8 Übersicht
- 71 Vollhartmetall-Schaftfräser
- 99 Vollhartmetall-Schruppfräser
- 105 Vollhartmetall-Torusfräser
- 121 Vollhartmetall-Radiusfräser
- 137 Vollhartmetall-Spezialfräser
- 143 Diamant-Messerkopf-Systeme
- 179 Schnittdaten Fräsen
- 239 Piktogramm-Übersicht
- 241 Anfrageformular für Sonderwerkzeuge
- 244 HAM Produktlinien

HAM milling tools

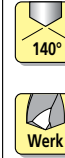
- 8 *program*
- 71 *solid carbide end mills*
- 99 *solid carbide roughing end mills*
- 105 *solid carbide toric end mills*
- 121 *solid carbide ball nose end mills*
- 137 *solid carbide special end mills*
- 143 *diamond milling cutter systems*
- 179 *cutting data milling*
- 239 *overview of pictograms*
- 241 *inquiry form for special tools*
- 244 *HAM product lines*



									
Bezeichnung / description	Vollhartmetall-Spiralbohrer								
DIN / DIN	Werk	6539	338	Werk	338	Werk	6539	6537 K	6537
kurz/lang / short/long	—	—	—	—	—	—	—	3 x D	5 x D
Artikelnummer / article number	30-1000	30-1081	30-1121	30-1160	30-1200	30-1301	30-1320	30-1621	30-1701
Seite / page	14	15	17	19	20	21	22	24	26
Schnittdaten Seite / cutting data page	154	155	157	159	160	161	162	163	163
Typ / type	N	N	N	W	W	N	N	Werk	Werk
Schneidstoff / cutting material	VHM	VHM	VHM	VHM	VHM	VHM	VHM	VHM	VHM
Zähnezahl / number of teeth	2	2	2	2	2	2	2	2	2
Beschichtung / coating	—	TA	TA	—	—	TA	—	TA-C	TA-C
Ø in mm / Ø in mm	0,5 – 3	0,5 – 16	1 – 16	0,5 – 3	1 – 6	0,1 – 3	3 – 16	2,8 – 20	3 – 16
Innenkühlung / interior coolant	—	—	—	—	—	—	—	—	—
Spitzenwinkel / point angle	120°	120°	120°	130°	130°	140°	Sichelform	140°	140°
Schneidrichtung / cutting direction	rechts	rechts	rechts	rechts	rechts	rechts	rechts	rechts	rechts
Nutform / flute design	Spirale	Spirale	Spirale	Spirale	Spirale	Spirale	Spirale	Spirale	Spirale
technische Ausführung / technical design									
									
Werkstoffgruppe / material group									
Alu Knetlegierungen / wrought aluminium alloys	○	○	○	●	●		○		
Alu Gusslegierungen / casting aluminium alloys	○	○	○	●	●		○		
Stahl / steel < 800 N/mm ²	○	●	●	○	○	●		●	●
Stahl / steel < 1200 N/mm ²	○	●	●	○	○	●		●	●
Stahl / steel < 1600 N/mm ²	○	○	○			●		●	●
Stahl / steel < 55 HRC						○		●	●
Stahl / steel < 60 HRC									
Stahl / steel < 66 HRC									
INOX / stainless steel < 800 N/mm ²	○	○	○	○	○	●		○	○
INOX / stainless steel > 800 N/mm ²	○	○	○	○	○	○		○	○
GG / lamellar graphite cast iron	○	●	●	○	○	●		●	●
GGG / spheroidal graphite cast iron	○	●	●			●		●	●
hochw. Legierungen / high-temperature alloys								○	○
Titan / titanium				○	○	●		○	○
NE-Metalle / Cu-Leg. / non-ferrous metals / copper alloys	●	○	○	●	●		○		
Graphit & Faserverbund / graphite & fibre composite				○	○		●		

● sehr gut geeignet / very suitable ○ bedingt geeignet / limited suitable



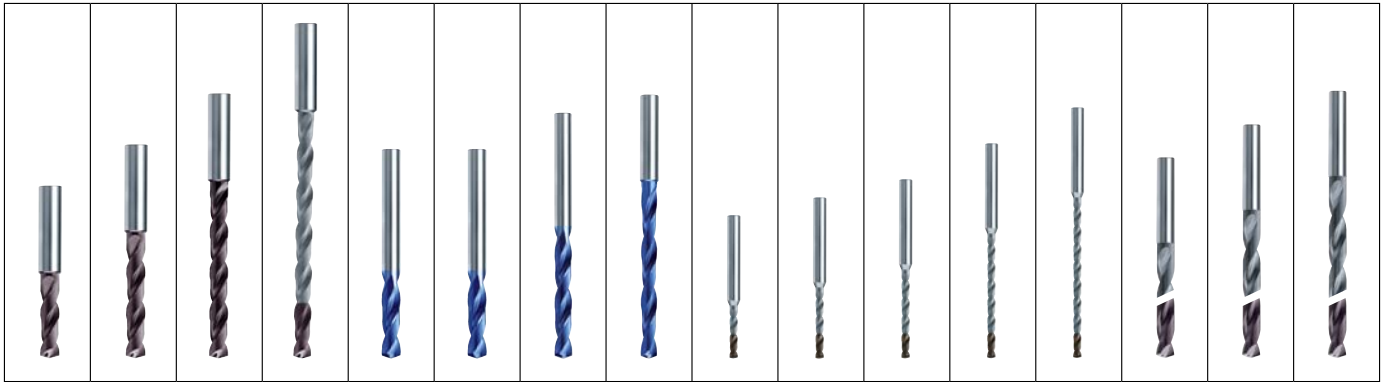









































Es gelten unsere Allgemeinen Geschäftsbedingungen unter www.ham-tools.com
 Our General Terms and Conditions apply to any product or service, available at www.ham-tools.com



HAM Superdrill				HAM Nirodrill				Vollhartmetall-Tieflochbohrer							
6537 K	6537	Werk	Werk	6537 K	Werk	6537	Werk	Werk	Werk	Werk	Werk	Werk	Werk	Werk	Werk
3 x D	5 x D	8 x D	12 x D	3 x D	3 x D	5 x D	8 x D	5 x D	8 x D	12 x D	15 x D	20 x D	15 x D	20 x D	25 x D
30-1741	30-1781	30-1821	30-1861	30-1881	30-1891	30-1901	30-1941	30-2181	30-2221	30-2261	30-2301	30-2341	30-2381	30-2421	30-2461
28	30	32	33	36	37	38	40	45	46	47	48	49	50	51	52
164	164	164	165	167	166	167	167	168	168	168	169	169	170	170	170
Werk	Werk	Werk	Werk	Werk	Werk	Werk	Werk	Werk	Werk	Werk	Werk	Werk	Werk	Werk	Werk
VHM	VHM	VHM	VHM	VHM	VHM	VHM	VHM	VHM	VHM	VHM	VHM	VHM	VHM	VHM	VHM
2	2	2	2	2	2	2	2	2	2	2	2	2	2	2	2
TA-C	TA-C	TA-C	TA-C	TA-CN	TA-CN	TA-CN	TA-CN	TA	TA	TA	TA	TA	TA-C	TA-C	TA-C
3 - 22	3 - 20	3 - 18	3 - 12	3 - 14	2 - 16	3 - 16	3 - 16	0,8 - 3	0,8 - 3	0,8 - 3	0,8 - 3	0,8 - 3	3 - 14	3 - 12	3 - 10
IK	IK	IK	IK	IK	—	IK	IK	IK	IK	IK	IK	IK	IK	IK	IK
140°	140°	140°	140°	140°	140°	140°	140°	135°	135°	135°	135°	135°	137°	137°	137°
rechts	rechts	rechts	rechts	rechts	rechts	rechts	rechts	rechts	rechts	rechts	rechts	rechts	rechts	rechts	rechts
Spirale	Spirale	Spirale	Spirale	Spirale	Spirale	Spirale	Spirale	Spirale	Spirale	Spirale	Spirale	Spirale	Spirale	Spirale	Spirale

				●	●	●	●								
				●	●	●	●								
●	●	●	●					●	●	●	●	●	●	●	●
●	●	●	●					●	●	●	●	●	●	●	●
●	●	●	●					○	○	○	○	○	○	○	○
●	●	●	●												
○	○	○	○	●	●	●	●	●	●	●	●	●	●	●	●
○	○	○	○	●	●	●	●	○	○	○	○	○	○	○	○
●	●	●	●	○	○	○	○	●	●	●	●	●	●	●	●
●	●	●	●					●	●	●	●	●	●	●	●
○	○	○	○	○	○	○	○	○	○	○	○	○	○	○	○
○	○	○	○	●	●	●	●	○	○	○	○	○	○	○	○
				●	●	●	●								
				○	○	○	○								

● sehr gut geeignet / very suitable ○ bedingt geeignet / limited suitable

													
Bezeichnung	Vollhartmetall-Tieflochbohrer							Spezialbohrer			Reibahlen		
DIN	Werk	Werk	Werk	Werk	Werk	Werk	Werk	333 A	Werk	Werk	335 C	Werk	Werk
kurz/lang	30 x D	40 x D	15 x D	20 x D	25 x D	30 x D	40 x D	—	—	—	—	—	—
Artikelnummer	30-2501	30-2541	30-2580	30-2620	30-2660	30-2700	30-2740	30-2800	30-2841	30-2881	30-2921	50-1040	50-1080
Seite	53	54	55	56	57	58	59	62	63	64	65	68	69
Schnittdaten Seite	170	170	171	171	171	171	171	172	173	174	175	177	178
Typ	Werk	Werk	Werk	Werk	Werk	Werk	Werk	N	N	N	Werk	Werk	Werk
Schneidstoff	VHM	VHM	VHM	VHM	VHM	VHM	VHM	VHM	VHM	VHM	VHM	VHM	VHM
Zähnezahl	2	2	2	2	2	2	2	2	2	2	3	4 – 6	6 – 8
Beschichtung	TA-C	TA-C	—	—	—	—	—	—	TA	TA	TA	—	—
Ø in mm	3 – 8	4 – 5	3 – 14	2 – 12	3 – 12	2 – 12	4 – 5	0,5 – 6,3	5 – 20	5 – 20	6,3 – 31	2 – 12	3 – 14
Innenkühlung	IK	IK	IK	IK	IK	IK	IK	—	—	—	—	—	—
Spitzenwinkel	137°	137°	137°	137°	137°	137°	137°	120°	120°	90°	90°	90°/120°	90°/120°
Schneidrichtung	rechts	rechts	rechts	rechts	rechts	rechts	rechts	rechts	rechts	rechts	rechts	rechts	rechts
Nutform	Spirale	Spirale	Spirale	Spirale	Spirale	Spirale	Spirale	Spirale	Spirale	Spirale	ger. Nut	li. Spirale	re. Spirale
techn. Ausführung													
													
													
Werkstoffgruppe													
Alu Knetlegierungen			●	●	●	●	●	●	○	○	○	●	●
Alu Gusslegierungen			●	●	●	●	●	●	○	○	○	●	●
Stahl < 800 N/mm ²	●	●						●	●	●	●	●	●
Stahl < 1200 N/mm ²	●	●						●	●	●	●	●	●
Stahl < 1600 N/mm ²	○	○						●	○	○	●	●	●
Stahl < 55 HRC											●	●	●
Stahl < 60 HRC											○		
Stahl < 66 HRC													
INOX < 800 N/mm ²	●	●						○	○	○	○	○	○
INOX > 800 N/mm ²	○	○						○	○	○	○	○	○
GG	●	●						●	●	●	●	●	●
GGG	●	●						●	●	●	●	●	●
hochw. Legierungen	○	○						○	○	○	○	○	○
Titan	○	○						○	○	○	○	○	○
NE-Metalle / Cu-Leg.			●	●	●	●	●	●	○	○	○	●	●
Graphit & Faserverbund									○	○	○		

● sehr gut geeignet / very suitable ○ bedingt geeignet / limited suitable



Spezial-Poliervverfahren

special-polishing process

Spezial-Poliervverfahren HSF TECHNOLOGY (Hybrid Surface Finish)

HAM bietet mit der HSF TECHNOLOGY ein Poliervverfahren für Werkzeuge mit spiegelglatten Oberflächen an.

Vorteile:









































- Optimale Späneabfuhr
- Reduzierung von Aufbauschneiden
- Definierte Schneidkantenverrundungen
- Oberflächen lassen sich reproduzierbar und homogen herstellen
- Höhere Schnitt- und Vorschubgeschwindigkeiten sind möglich
- Reduzierte Schnittkräfte
- Weniger Wärme am Werkzeug und Werkstück

Special-polishing process HSF TECHNOLOGY (Hybrid Surface Finish)

HAM is offering a polishing process for tools with hyper smooth surfaces using the HSF TECHNOLOGY.

Advantages:

- Optimal chip removal
- Reduction of built-up edges
- Defined cutting edge rounding
- Homogeneous and reproducible surfaces can be reached
- Higher cutting speeds and feed rates are possible
- Reduced cutting forces
- Less heat generation on the tool and workpiece

												
Bezeichnung / description	Vollhartmetall-Schaftfräser											
DIN / DIN	Werk	Werk	Werk	Werk	Werk	6527	Werk	6527	Werk	6527	6527	6527
kurz/lang / short/long	kurz	kurz/lang	kurz	kurz	lang	lang	—	lang	—	lang	lang	lang
Artikelnummer / article number	40-1001	40-1041	40-5380	40-5390	40-5490	40-1080	40-1161	40-1201	40-1281	40-1321	40-1360	40-1360
Seite / page	72	73	74	75	76	77	78	79	80	81	82	82
Schnittdaten Seite / cutting data page	180	181	182	183	184	185	186	187	188	189	190	190
Typ / type	W	W	W	W	W	W	N	N	N	N	N	N
Schneidstoff / cutting material	VHM	VHM	VHM	VHM	VHM	VHM	VHM	VHM	VHM	VHM	VHM	VHM
Zähnezahl / number of teeth	1	2	3	3	3	2	2	2	3	3	3	3
Beschichtung / coating	TA-AL	TA-AL	—	—	—	—	TA	TA	TA	TA	—	—
Ø in mm / Ø in mm	0,3 – 10	1 – 20	6 – 20	3 – 20	3 – 20	0,3 – 3	0,3 – 20	2 – 12	0,6 – 20	3 – 20	8 – 20	8 – 20
Innenkühlung / interior coolant	—	—	IK	—	—	—	—	—	—	—	—	IK
Anwendung / application												
												
												
												
Werkstoffgruppe / material group												
Alu Knetlegierungen / wrought aluminium alloys	●	●	●	●	●	●	○	○	○	○	○	○
Alu Gusslegierungen / casting aluminium alloys	●	●	●	●	●	●	○	○	○	○	○	○
Stahl / steel < 800 N/mm ²							●	●	●	●	●	●
Stahl / steel < 1200 N/mm ²							●	●	●	●	●	●
Stahl / steel < 1600 N/mm ²							○	○	●	●	●	●
Stahl / steel < 55 HRC									○	○	○	○
Stahl / steel < 60 HRC												
Stahl / steel < 66 HRC												
INOX / stainless steel < 800 N/mm ²						○	○	○	○	○	○	○
INOX / stainless steel > 800 N/mm ²						○	○	○	○	○	○	○
GG / lamellar graphite cast iron							●	●	●	●	●	●
GGG / spheroidal graphite cast iron							●	●	●	●	●	●
hochw. Legierungen / high-temperature alloys							○	○	○	○	○	○
Titan / titanium							○	○	○	○	○	○
NE-Metalle / Cu-Leg. / non-ferrous metals/copper alloys	○	○	●	●	●	●	○	○	○	○	○	○
Graphit & Faserverbund / graphite & fibre composite	○	○				○						

● sehr gut geeignet / very suitable ○ bedingt geeignet / limited suitable



Vollhartmetall-Schaftfräser

Werk lang	Werk —	6527 kurz/lang	6527 —	6527 kurz	6527 lang	Werk extralang	Werk kurz	Werk lang	Werk extralang	Werk extralang	Werk extralang	Werk kurz	Werk lang	Werk kurz	Werk lang	
40-1401	40-1441	40-5151	40-5181	40-1491	40-1521	40-5120	40-5091	40-5191	40-5291	40-1561	40-1571	40-5200	40-5240	40-5280	40-5320	
83	84	85	86	87	88	89	90	91	92	93	94	95	96	97	98	
191	192	194	195	196	197	198	199	199	201	203	204	205	205	206	206	
N	N	N	N	N	N	N	N	N	N	N	N	N	H	H	H	H
VHM	VHM	VHM	VHM	VHM	VHM	VHM	VHM	VHM	VHM	VHM	VHM	VHM	VHM	VHM	VHM	VHM
3	4	4	4	4	4	4-6	5	5	5	6-8	6-8	4-8	6-8	6-8	6-8	
TA	TA	TA	TA	TA	TA	TA	TA-B	TA-B	TA-B	TA	TA	TA-X	TA-X	TA-X	TA-X	
0,4-25	2-20	3-26	4-20	3-20	3-25	6-32	6-20	6-20	10-20	6-32	6-32	3-32	6-25	6-20	6-25	
—	—	—	—	—	—	—	—	—	—	—	—	—	—	—	—	

○		○	○	○	○	○				○	○				
○	○	○	○	○	○	○				○	○				
●	●	●	●	●	●	●	●	●	●	●	●				
●	●	●	●	●	●	●	●	●	●	●	●				
○	●	●	●	●	○	●	●	●	●	●	●				
	○					○				○	○	●	●	●	●
												●	●	●	●
												●	●	●	●
●	○	●	●	●	●	○	●	●	●	●	●				
●	○	●	●	●	●	○	●	●	●	●	●				
●	●	●	●	●	●	●	●	●	●	●	●				
●	●	●	●	●	●	●	●	●	●	●	●				
○	○	○	○	○	○	○	○	○	○	○	○				
●	○	●	●	●	●	○	○	○	○	○	○				
○	○	○	○	○	○	○				○	○				

● sehr gut geeignet / very suitable ○ bedingt geeignet / limited suitable

Bezeichnung	Vollhartmetall-Schruppfräser				Vollhartmetall-Torusfräser								
DIN	Werk	Werk	Werk	Werk	Werk	Werk	Werk	Werk	Werk	Werk	Werk	Werk	Werk
kurz/lang	lang	lang	lang	kurz	lang	lang	extra lang	—	—	—	extra lang	—	kurz
Artikelnummer	40-5351	40-1691	40-1681	40-1600	40-5400	40-5460	40-5480	40-6120	40-6130	40-5360	40-5600	40-5500	40-5520
Seite	100	101	102	103	106	107	108	109	112	115	116	117	118
Schnittdaten Seite	207	208	209	210	211	212	213	214	214	216	217	218	219
Typ	W	HR	HR	W	W	W	W	H	H	H	W	H	H
Schneidstoff	VHM	VHM	VHM	VHM	VHM	VHM	VHM	VHM	VHM	VHM	VHM	VHM	VHM
Zähnezahl	3	4	3-6	8-12	2	2	2	2	2	2	4	3-4	4
Beschichtung	TA-AL	TA-T	TA-T	—	—	TA-AL	Diamant	TA-X	TA-X	TA-X	Diamant	TA-X	TA-X
Ø in mm	3-20	6-25	4-25	4-20	1-16	0,2-6	0,2-6	0,2-6	0,2-6	0,5-6	2-12	2-16	2-16
Innenkühlung	—	—	—	—	—	—	—	—	—	—	—	—	—
Anwendung													

Vollhartmetall-Radiusfräser											Vollhartmetall-Spezialfräser				
Werk lang	Werk kurz/lang	Werk extra lang	Werk kurz/lang	Werk kurz/lang	Werk kurz	Werk lang	Werk kurz	Werk extra lang	Werk lang	Werk lang	Werk —	Werk kurz	Werk kurz	Werk kurz	Werk —
40-5560	40-5860	40-5880	40-6080	40-6090	40-5680	40-5720	40-5760	40-5920	40-5981	40-5800	40-1880	40-1921	40-1961	40-2001	40-2041
119	122	123	124	127	130	131	132	133	134	135	138	139	140	141	142
219	220	221	222	222	224	224	225	227	228	229	230	231	232	233	234
H	W	W	H	H	N	N	H	H	H	H	N	N	N	N	N
VHM	VHM	VHM	VHM	VHM	VHM	VHM	VHM	VHM	VHM	VHM	VHM	VHM	VHM	VHM	VHM
4	2	2	2	2	2	2	2	3	4	2	1	4	4	4	4
TA-X	TA-AL	Diamant	TA-X	TA-X	TA	TA	TA-X	TA-X	TA-X	TA-X	—	TA	TA	TA	TA
2 – 16	0,2 – 6	0,2 – 6	0,2 – 6	0,2 – 6	0,4 – 20	4 – 20	0,4 – 16	2 – 20	3 – 20	1 – 10	0,2 – 0,25	4 – 20	4 – 12	6 – 20	2,8 – 9,8
—	—	—	—	—	—	—	—	—	—	—	—	—	—	—	—
W+F	W+F	W+F	W+F	W+F	W+F	W+F	W+F	W+F	W+F	W+F					
HSF	HSF		HSF	HSF						HSF					

	●										●	●	●	●	●
	●										●	●	●	●	●
●			●	●	●	●	○		●	○	●	●	●	●	●
●			●	●	●	●	●		●	●	●	●	●	●	●
●			●	●	●	●	●	○	●	●	●	●	●	●	●
○			●	●	○	○	●	●	●	●		○	○	○	○
			●	●			●	●	○	○					
							○	●							
○	○		○	○	○	○	○		○	○		●	●	●	●
○	○		○	○	○	○	○		○	○		●	●	●	●
●			●	●	●	●	●	●	●	●	●	●	●	●	●
●			●	●	●	●	●	●	●	●	●	●	●	●	●
							○					○	○	○	○
	○						○					○	○	○	○
	●										●	●	●	●	●
	○	●									○	○	○	○	○

● sehr gut geeignet / very suitable ○ bedingt geeignet / limited suitable

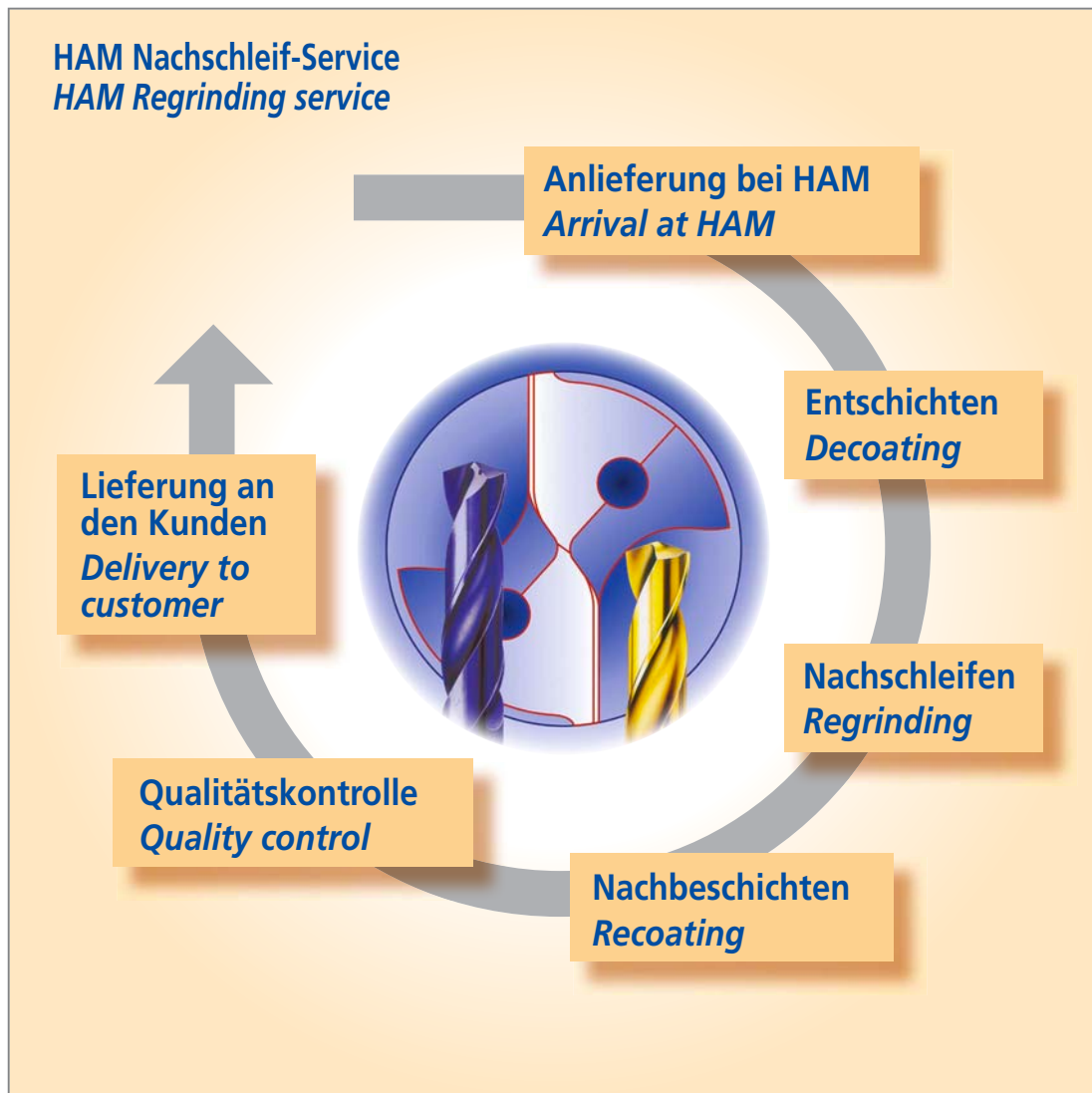

Messgerät zur Schneideneinstellung.
Measure machine for cutting edge adjustment.



HAM Beschichtungsanlagen.
HAM Coating machines.

Spiralbohrer

spiral drills



HAM Spiralbohrer – zum universellen Einsatz geeignete Vollhartmetall-Werkzeuge.

HAM Spiral drills – particular suitable for universal workpiece materials.

HAM 30-1000

Vollhartmetall-Spiralbohrer solid carbide spiral drill

VHM
 Z 2
 30° rechts
 Werk Norm
 Typ N
 120°
 HA

Konstruktions-Daten

- 4-Flächenanschliff
- Ausspitzung DIN 1412 Form A
- Spiralwinkel 30°

Engineering data

- 4-facet ground
- web thinning DIN 1412 form A
- 30° RH helix

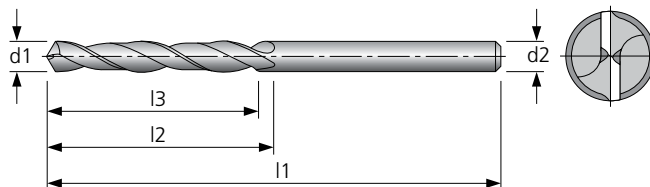

Material	Alu Knet-leg.	Alu Guss-leg.	Stahl < 800 N/mm²	Stahl < 1200 N/mm²	Stahl < 1600 N/mm²	Stahl < 55 HRC	Stahl < 60 HRC	Stahl < 66 HRC	INOX < 800 N/mm²	INOX > 800 N/mm²	GG	GGG	hochw. Legierungen	Titan	NE-Metalle Cu-Leg.	Graphit & Faser-verbund	MMS	max.	ohne	AIR
30-1000	○	○	○	○	○				○	○	○	○			●		○	○	○	○

Schnittdaten siehe Seite / cutting data available on page - 154

● sehr gut geeignet / very suitable ○ bedingt geeignet / limited suitable

Ø d1 (h7) mm	30-1000	l3 mm	l2 mm	l1 mm	Ø d2 (h6) mm	Ø d1 (h7) mm	30-1000	l3 mm	l2 mm	l1 mm	Ø d2 (h6) mm
0,5		4,5	5,5	30	0,5	1,6		15	17,5	40	1,6
0,55		4,5	5,5	30	0,55	1,7		15	17,5	40	1,7
0,6		4,5	5,5	30	0,6	1,8		15	17,5	40	1,8
0,65		5,5	6,5	30	0,65	1,9		15	17,5	40	1,9
0,7		5,5	6,5	30	0,7	2		15	17,5	40	2
0,75		7,5	8,5	30	0,75	2,1		15	18	40	2,1
0,8		7,5	8,5	30	0,8	2,2		15	18	40	2,2
0,85		8	9,5	30	0,85	2,3		15	18	40	2,3
0,9		8	9,5	30	0,9	2,4		15	18	40	2,4
0,95		9,5	11	30	0,95	2,5		15	18	40	2,5
1		9,5	11	30	1	2,6		16	20	45	2,6
1,1		9,5	11	30	1,1	2,7		16	20	45	2,7
1,15		11	13	30	1,15	2,8		16	20	45	2,8
1,2		11	13	30	1,2	2,9		16	20	45	2,9
1,25		11	13	30	1,25	3		16	20	45	3
1,3		11	13	30	1,3						
1,35		11	13	30	1,35						
1,4		11	13	30	1,4						
1,45		11	13	30	1,45						
1,5		11	13	30	1,5						

Für Zwischenabmessungen Preis auf Anfrage
For intermediate sizes price on request

Bestellbeispiel / Order example: 30-1000-1,6

HAM 30-1080

Vollhartmetall-Spiralbohrer solid carbide spiral drill

VHM Z 2 30° rechts DIN 6539
Typ N 120° HA

Konstruktions-Daten

- 4-Flächenanschliff
- Ausspitzung DIN 1412 Form A
- Spiralwinkel 30°

Engineering data

- 4-facet ground
- web thinning DIN 1412 form A
- 30° RH helix

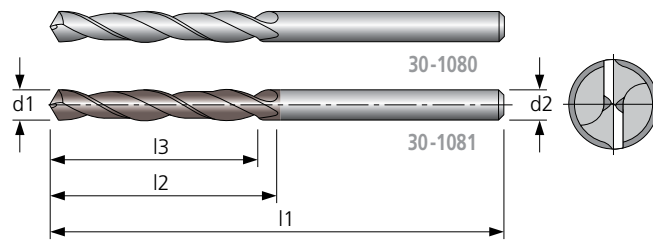

Material	Alu Knet-leg.	Alu Guss-leg.	Stahl < 800 N/mm²	Stahl < 1200 N/mm²	Stahl < 1600 N/mm²	Stahl < 55 HRC	Stahl < 60 HRC	Stahl < 66 HRC	INOX < 800 N/mm²	INOX > 800 N/mm²	GG	GGG	hochw. Legierungen	Titan	NE-Metalle Cu-Leg.	Graphit & Faser-verbund	MMS	max.	ohne	AIR
30-1080	○	○	○	○	○				○	○	○	○			●		○	●	○	○
30-1081	○	○	●	●	○				○	○	●	●			○		○	●	○	○

Schnittdaten siehe Seite / cutting data available on page – 155

● sehr gut geeignet / very suitable ○ bedingt geeignet / limited suitable

Ø d1 (h7) mm	30-1080	30-1081	l3 mm	l2 mm	l1 mm	Ø d2 (h6) mm	Ø d1 (h7) mm	30-1080	30-1081	l3 mm	l2 mm	l1 mm	Ø d2 (h6) mm
		TA							TA				
0,5			2,1	3	20	0,5	4			17	22	55	4
0,6			2,5	3,5	21	0,6	4,1			17	22	55	4,1
0,7			3,2	4,5	23	0,7	4,2			17	22	55	4,2
0,8			3,5	5	24	0,8	4,3			18	24	58	4,3
0,9			3,9	5,5	25	0,9	4,4			18	24	58	4,4
1			4,5	6	26	1	4,5			18	24	58	4,5
1,1			5,5	7	28	1,1	4,6			18	24	58	4,6
1,2			6	8	30	1,2	4,7			18	24	58	4,7
1,3			6	8	30	1,3	4,8			20	26	62	4,8
1,4			7	9	32	1,4	4,9			20	26	62	4,9
1,5			7	9	32	1,5	5			20	26	62	5
1,6			7,5	10	34	1,6	5,1			20	26	62	5,1
1,7			7,5	10	34	1,7	5,2			20	26	62	5,2
1,8			8,5	11	36	1,8	5,3			20	26	62	5,3
1,9			8,5	11	36	1,9	5,4			21	28	66	5,4
2			9	12	38	2	5,5			21	28	66	5,5
2,1			9	12	38	2,1	5,6			21	28	66	5,6
2,2			10	13	40	2,2	5,7			21	28	66	5,7
2,3			10	13	40	2,3	5,8			21	28	66	5,8
2,4			11	14	43	2,4	5,9			21	28	66	5,9
2,5			11	14	43	2,5	6			21	28	66	6
2,6			11	14	43	2,6	6,1			23	31	70	6,1
2,7			12	16	46	2,7	6,2			23	31	70	6,2
2,8			12	16	46	2,8	6,3			23	31	70	6,3
2,9			12	16	46	2,9	6,4			23	31	70	6,4
3			12	16	46	3	6,5			23	31	70	6,5
3,1			14	18	49	3,1	6,6			23	31	70	6,6
3,2			14	18	49	3,2	6,7			23	31	70	6,7
3,3			14	18	49	3,3	6,8			25	34	74	6,8
3,4			15	20	52	3,4	7			25	34	74	7
3,5			15	20	52	3,5	7,1			25	34	74	7,1
3,6			15	20	52	3,6	7,2			25	34	74	7,2
3,7			15	20	52	3,7	7,3			25	34	74	7,3
3,8			17	22	55	3,8	7,4			25	34	74	7,4
3,9			17	22	55	3,9	7,5			25	34	74	7,5

Für Zwischenabmessungen Preis auf Anfrage
For intermediate sizes price on request

Bestellbeispiel / Order example: 30-1080-4

Ø d1 (h7) mm	30-1080	30-1081	l3 mm	l2 mm	l1 mm	Ø d2 (h6) mm
		TA				
7,6			27	37	79	7,6
7,7			27	37	79	7,7
7,8			27	37	79	7,8
7,9			27	37	79	7,9
8			27	37	79	8
8,1			27	37	79	8,1
8,2			27	37	79	8,2
8,4			27	37	79	8,4
8,5			27	37	79	8,5
8,6			29	40	84	8,6
8,7			29	40	84	8,7
8,8			29	40	84	8,8
9			29	40	84	9
9,5			29	40	84	9,5

Für Zwischenabmessungen Preis auf Anfrage
For intermediate sizes price on request

Ø d1 (h7) mm	30-1080	30-1081	l3 mm	l2 mm	l1 mm	Ø d2 (h6) mm
		TA				
10			31	43	89	10
10,2			31	43	89	10,2
10,5			31	43	89	10,5
11			33	47	95	11
11,5			33	47	95	11,5
12			35	51	102	12
12,5			35	51	102	12,5
13			35	51	102	13
14			37	54	107	14
15			38	56	111	15
16			38	58	115	16

Bestellbeispiel / Order example: 30-1080-10

HAM 30-1120

Vollhartmetall-Spiralbohrer solid carbide spiral drill

VHM
Z 2
30° rechts
DIN 338

Typ N
120°
HA

Konstruktions-Daten

- 4-Flächenanschliff
- Ausspitzung DIN 1412 Form A
- Spiralwinkel 30°

Engineering data

- 4-facet ground
- web thinning DIN 1412 form A
- 30° RH helix

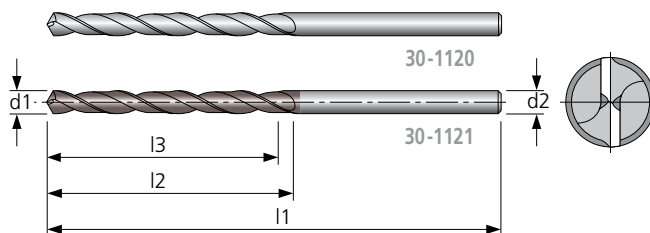

Material	Alu Knet-leg.	Alu Guss-leg.	Stahl < 800 N/mm²	Stahl < 1200 N/mm²	Stahl < 1600 N/mm²	Stahl < 55 HRC	Stahl < 60 HRC	Stahl < 66 HRC	INOX < 800 N/mm²	INOX > 800 N/mm²	GG	GGG	hochw. Legierungen	Titan	NE-Metalle Cu-Leg.	Graphit & Faser-verbund	MMS	max.	ohne	AIR	
30-1120	○	○	○	○	○				○	○	○	○			●		○	○	●	○	○
30-1121	○	○	●	●	○				○	○	●	●			○		○	○	●	○	○

Schnittdaten siehe Seite / cutting data available on page – 157

● sehr gut geeignet / very suitable ○ bedingt geeignet / limited suitable

Ø d1 (h7) mm	30-1120	30-1121	l3 mm	l2 mm	l1 mm	Ø d2 (h6) mm	Ø d1 (h7) mm	30-1120	30-1121	l3 mm	l2 mm	l1 mm	Ø d2 (h6) mm
		TA							TA				
1			10,5	12	34	1	4,5			41	47	80	4,5
1,1			12,5	14	36	1,1	4,6			41	47	80	4,6
1,2			14	16	38	1,2	4,7			41	47	80	4,7
1,3			14	16	38	1,3	4,8			45	52	86	4,8
1,4			16	18	40	1,4	4,9			45	52	86	4,9
1,5			16	18	40	1,5	5			45	52	86	5
1,6			17,5	20	43	1,6	5,1			45	52	86	5,1
1,7			17,5	20	43	1,7	5,2			45	52	86	5,2
1,8			19,5	22	46	1,8	5,3			45	52	86	5,3
1,9			19,5	22	46	1,9	5,4			49	57	93	5,4
2			21	24	49	2	5,5			49	57	93	5,5
2,1			21	24	49	2,1	5,6			49	57	93	5,6
2,2			24	27	53	2,2	5,7			49	57	93	5,7
2,3			24	27	53	2,3	5,8			49	57	93	5,8
2,4			26	30	57	2,4	5,9			49	57	93	5,9
2,5			26	30	57	2,5	6			49	57	93	6
2,6			26	30	57	2,6	6,1			55	63	101	6,1
2,7			29	33	61	2,7	6,2			55	63	101	6,2
2,8			29	33	61	2,8	6,3			55	63	101	6,3
2,9			29	33	61	2,9	6,4			55	63	101	6,4
3			29	33	61	3	6,5			55	63	101	6,5
3,1			32	36	65	3,1	6,6			55	63	101	6,6
3,2			32	36	65	3,2	6,7			55	63	101	6,7
3,3			32	36	65	3,3	6,8			60	69	109	6,8
3,4			34	39	70	3,4	6,9			60	69	109	6,9
3,5			34	39	70	3,5	7			60	69	109	7
3,6			34	39	70	3,6	7,1			60	69	109	7,1
3,7			34	39	70	3,7	7,3			60	69	109	7,3
3,8			37	43	75	3,8	7,5			60	69	109	7,5
3,9			37	43	75	3,9	7,6			64	75	117	7,6
4			37	43	75	4	7,7			64	75	117	7,7
4,1			37	43	75	4,1	7,8			64	75	117	7,8
4,2			37	43	75	4,2	7,9			64	75	117	7,9
4,3			41	47	80	4,3	8			64	75	117	8
4,4			41	47	80	4,4	8,1			64	75	117	8,1

Für Zwischenabmessungen Preis auf Anfrage
For intermediate sizes price on request

Bestellbeispiel / Order example: 30-1120-4,5

Ø d1 (h7) mm	30-1120	30-1121	l3 mm	l2 mm	l1 mm	Ø d2 (h6) mm
		TA				
8,2			64	75	117	8,2
8,3			64	75	117	8,3
8,4			64	75	117	8,4
8,5			64	75	117	8,5
8,6			69	81	125	8,6
8,7			69	81	125	8,7
8,8			69	81	125	8,8
8,9			69	81	125	8,9
9			69	81	125	9
9,5			69	81	125	9,5

Für Zwischenabmessungen Preis auf Anfrage
 For intermediate sizes price on request

Ø d1 (h7) mm	30-1120	30-1121	l3 mm	l2 mm	l1 mm	Ø d2 (h6) mm
		TA				
10			74	87	133	10
10,5			74	87	133	10,5
11			80	94	142	11
11,5			80	94	142	11,5
12			85	101	151	12
14			91	108	160	14
16			100	120	178	16

Bestellbeispiel / Order example: 30-1120-10

HAM 30-1160

Vollhartmetall-Spiralbohrer solid carbide spiral drill

VHM Z 2 30° rechts Werk Norm
Typ W 130° HA
SHRINK FIT

Konstruktions-Daten

- 4-Flächenanschliff
- Ausspitzung DIN 1412 Form A
- AMS-Geometrie
- Spiralwinkel 30°

Engineering data

- 4-facet ground
- web thinning DIN 1412 form A
- AMS geometry
- 30° RH helix

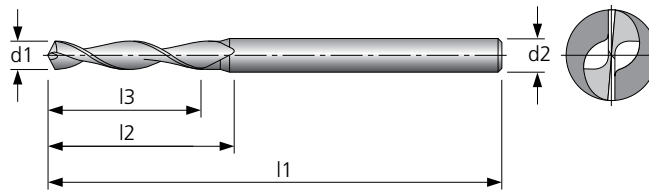

Material	Alu Knet-leg.	Alu Guss-leg.	Stahl < 800 N/mm²	Stahl < 1200 N/mm²	Stahl < 1600 N/mm²	Stahl < 55 HRC	Stahl < 60 HRC	Stahl < 66 HRC	INOX < 800 N/mm²	INOX > 800 N/mm²	GG	GGG	hochw. Legierungen	Titan	NE-Metalle Cu-Leg.	Graphit & Faser-verbund	MMS	max.	ohne	AIR
30-1160	●	●	○	○					○	○	○			○	●	○	○	●	○	○

Schnittdaten siehe Seite / cutting data available on page – 159

● sehr gut geeignet / very suitable ○ bedingt geeignet / limited suitable

Ø d1 (h7) mm	30-1160	l3 mm	l2 mm	l1 mm	Ø d2 (h6) mm
0,5		5	6	38	3
0,55		5	6	38	3
0,6		5	6	38	3
0,65		6	7	38	3
0,7		6	7	38	3
0,75		8	10	38	3
0,8		8	10	38	3
0,85		8	10	38	3
0,9		10	12	38	3
0,95		10	12	38	3
1		10	12	38	3
1,05		10	12	38	3
1,1		10	12	38	3
1,15		10	12	38	3
1,2		12	15	38	3
1,25		12	15	38	3
1,3		12	15	38	3
1,4		12	15	38	3
1,45		12	15	38	3
1,5		12	15	38	3

Ø d1 (h7) mm	30-1160	l3 mm	l2 mm	l1 mm	Ø d2 (h6) mm
1,6		12	15	38	3
1,65		12	15	38	3
1,7		12	15	38	3
1,8		12	15	38	3
1,85		12	15	38	3
1,9		12	15	38	3
2		14	16,5	38	3
2,05		14	16,5	38	3
2,1		14	16,5	38	3
2,2		14	16,5	38	3
2,3		14	16,5	38	3
2,4		14	16,5	38	3
2,5		14	16,5	38	3
2,6		14	16,5	38	3
2,7		14	16,5	38	3
2,8		14	16,5	38	3
2,9		14	16,5	38	3
3		14	16,5	38	3

Für Zwischenabmessungen Preis auf Anfrage
For intermediate sizes price on request

Bestellbeispiel / Order example: 30-1160-1,6

HAM 30-1200

Vollhartmetall-Spiralbohrer
solid carbide spiral drill

VHM
Z 2
30° rechts
DIN 338

Typ W
130°
HA

Konstruktions-Daten

- 4-Flächenanschliff
- Ausspitzung DIN 1412 Form B
- verstärkter Kern
- AMS-Geometrie
- Spiralwinkel 30°

Engineering data

- 4-facet ground
- web thinning DIN 1412 form B
- reinforced web thickness
- AMS geometry
- 30° RH helix

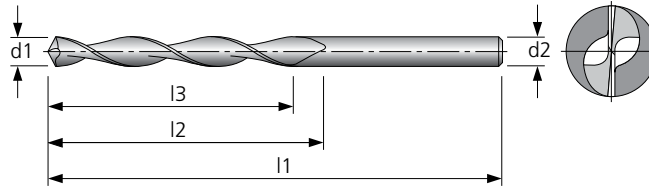

Material	Alu Knet-leg.	Alu Guss-leg.	Stahl < 800 N/mm²	Stahl < 1200 N/mm²	Stahl < 1600 N/mm²	Stahl < 55 HRC	Stahl < 60 HRC	Stahl < 66 HRC	INOX < 800 N/mm²	INOX > 800 N/mm²	GG	GGG	hochw. Legierungen	Titan	NE-Metalle Cu-Leg.	Graphit & Faser-verbund	MMS	max.	ohne	AIR
30-1200	●	●	○	○					○	○	○			○	●	○	○	●	○	○

Schnittdaten siehe Seite / cutting data available on page – 160

● sehr gut geeignet / very suitable ○ bedingt geeignet / limited suitable

Ø d1 (h7) mm	30-1200	l3 mm	l2 mm	l1 mm	Ø d2 (h6) mm	Ø d1 (h7) mm	30-1200	l3 mm	l2 mm	l1 mm	Ø d2 (h6) mm
1		10	12	34	1	4		35	43	75	4
1,1		12	14	36	1,1	4,1		35	43	75	4,1
1,2		13	16	38	1,2	4,2		35	43	75	4,2
1,3		13	16	38	1,3	4,3		38	47	80	4,3
1,4		15	18	40	1,4	4,4		38	47	80	4,4
1,5		15	18	40	1,5	4,5		38	47	80	4,5
1,6		17	20	43	1,6	4,6		38	47	80	4,6
1,7		17	20	43	1,7	4,7		38	47	80	4,7
1,8		18	22	46	1,8	4,8		42	52	86	4,8
1,9		18	22	46	1,9	4,9		42	52	86	4,9
2		20	24	49	2	5		42	52	86	5
2,1		20	24	49	2,1	5,1		42	52	86	5,1
2,2		22	27	53	2,2	5,2		42	52	86	5,2
2,3		22	27	53	2,3	5,3		42	52	86	5,3
2,4		25	30	57	2,4	5,4		45	57	93	5,4
2,5		25	30	57	2,5	5,5		45	57	93	5,5
2,6		25	30	57	2,6	5,6		45	57	93	5,6
2,7		27	33	61	2,7	5,7		45	57	93	5,7
2,8		27	33	61	2,8	5,8		45	57	93	5,8
2,9		27	33	61	2,9	5,9		45	57	93	5,9
3		27	33	61	3	6		45	57	93	6
3,1		29	36	65	3,1						
3,2		29	36	65	3,2						
3,3		29	36	65	3,3						
3,4		32	39	70	3,4						
3,5		32	39	70	3,5						
3,6		32	39	70	3,6						
3,7		32	39	70	3,7						
3,8		35	43	75	3,8						
3,9		35	43	75	3,9						

Für Zwischenabmessungen Preis auf Anfrage
For intermediate sizes price on request

Bestellbeispiel / Order example: 30-1200-4

HAM 30-1301

Vollhartmetall-Spiralbohrer solid carbide spiral drill

VHM Z 2 30° rechts Werk Norm
Typ N 140° HA
HPC SHRINK FIT

Konstruktions-Daten

- 4-Flächenanschliff
- Ø d1 0,1 – 0,15 mm ohne Ausspitzung
- Ø d1 0,2 – 0,45 mm Ausspitzung DIN 1412 Form A
- ab Ø d1 0,5 mm Ausspitzung DIN 1412 Form C
- verstärkter Kern
- verstärkter Schaft
- hohe Rundlaufgenauigkeit
- Spiralwinkel 30°

Engineering data

- 4-facet ground
- Ø d1 0,1 – 0,15 mm no web thinning
- Ø d1 0,2 – 0,45 mm web thinning DIN 1412 form A
- from Ø d1 0,5 mm web thinning DIN 1412 form C
- reinforced web thickness
- reinforced shank
- high concentricity
- 30° RH helix

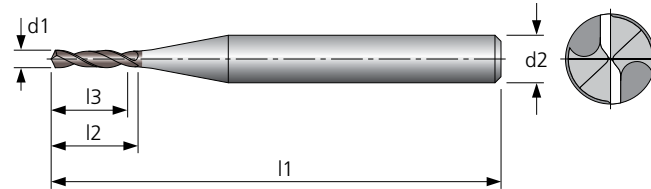

Material	Alu Knet-leg.	Alu Guss-leg.	Stahl < 800 N/mm²	Stahl < 1200 N/mm²	Stahl < 1600 N/mm²	Stahl < 55 HRC	Stahl < 60 HRC	Stahl < 66 HRC	INOX < 800 N/mm²	INOX > 800 N/mm²	GG	GGG	hochw. Legierungen	Titan	NE-Metalle Cu-Leg.	Graphit & Faser-verbund	MMS	max.	ohne	AIR
30-1301			●	●	●	○			●	○	●	●		●			●	●	○	○

Schnittdaten siehe Seite / cutting data available on page – 161

● sehr gut geeignet / very suitable ○ bedingt geeignet / limited suitable

Ø d1 (m7) mm	30-1301	l3 mm	l2 mm	l1 mm	Ø d2 (h6) mm	Ø d1 (m7) mm	30-1301	l3 mm	l2 mm	l1 mm	Ø d2 (h6) mm
	TA						TA				
0,1		0,5	1,5	38	3	1,6		8	11,5	38	3
0,15		0,75	1,8	38	3	1,65		8,25	11,75	38	3
0,2		1	2,4	38	3	1,7		8,5	12	38	3
0,25		1,25	2,7	38	3	1,75		8,75	12,25	38	3
0,3		1,5	3	38	3	1,8		9	12,5	38	3
0,35		1,75	3,3	38	3	1,85		9,25	12,75	38	3
0,4		2	3,6	38	3	1,9		9,5	13	38	3
0,45		2,25	3,8	38	3	1,95		9,75	13,5	38	3
0,5		2,5	4	38	3	2		10	14	46	4
0,55		2,75	4,6	38	3	2,05		10,25	14,5	46	4
0,6		3	4,8	38	3	2,1		10,5	15	46	4
0,65		3,25	5	38	3	2,15		10,75	15,5	46	4
0,7		3,5	6	38	3	2,2		11	16	46	4
0,75		3,75	6,2	38	3	2,25		11,25	16,5	46	4
0,8		4	6,4	38	3	2,3		11,5	17	46	4
0,85		4,25	6,7	38	3	2,35		11,75	17,5	46	4
0,9		4,5	7	38	3	2,4		12	18	46	4
0,95		4,75	7,25	38	3	2,45		12,25	18,5	46	4
1		5	7,5	38	3	2,5		12,5	19	46	4
1,05		5,25	7,75	38	3	2,55		12,75	19,5	50	4
1,1		5,5	8	38	3	2,6		13	20	50	4
1,15		5,75	8,25	38	3	2,65		13,25	20,5	50	4
1,2		6	8,5	38	3	2,7		13,5	21	50	4
1,25		6,25	8,75	38	3	2,75		13,75	21,5	50	4
1,3		6,5	9	38	3	2,8		14	22	50	4
1,35		6,75	9,5	38	3	2,85		14,25	22,5	50	4
1,4		7	10	38	3	2,9		14,5	23	50	4
1,45		7,25	10,5	38	3	2,95		14,75	23,5	50	4
1,5		7,5	11	38	3	3		15	24	50	4
1,55		7,75	11,25	38	3						

Für Zwischenabmessungen Preis auf Anfrage
For intermediate sizes price on request

Bestellbeispiel / Order example: 30-1301-1,6

HAM 30-1320

Vollhartmetall-Spiralbohrer solid carbide spiral drill

VHM
Z 2
30° rechts
DIN 6539

Typ N
HA

Konstruktions-Daten

- Sonderanschliff für Faser-verbundwerkstoffe
- Umfangsschneide in Sichelform
- Spiralwinkel 30°

Engineering data

- special point ground for fibre compound materials
- periphery cutting edge in sickle design
- 30° RH helix

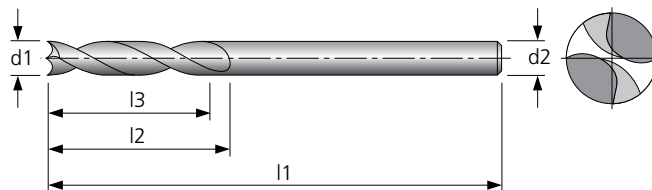

Material	Alu Knet-leg.	Alu Guss-leg.	Stahl < 800 N/mm²	Stahl < 1200 N/mm²	Stahl < 1600 N/mm²	Stahl < 55 HRC	Stahl < 60 HRC	Stahl < 66 HRC	INOX < 800 N/mm²	INOX > 800 N/mm²	GG	GGG	hochw. Legierungen	Titan	NE-Metalle Cu-Leg.	Graphit & Faser-verbund	MMS	max.	ohne	AIR
30-1320	○	○													○	●	●	●	●	●

Schnittdaten siehe Seite / cutting data available on page - 162

● sehr gut geeignet / very suitable ○ bedingt geeignet / limited suitable

30-1320						30-1320					
Ø d1 (h7) mm		l3 mm	l2 mm	l1 mm	Ø d2 (h6) mm	Ø d1 (h7) mm		l3 mm	l2 mm	l1 mm	Ø d2 (h6) mm
3		12	16	46	3	7		25	34	74	7
3,2		14	18	49	3,2	7,5		25	34	74	7,5
3,3		14	18	49	3,3	8		27	37	79	8
3,5		15	20	52	3,5	8,5		27	37	79	8,5
3,7		15	20	52	3,7	9		30	40	84	9
4		17	22	55	4	9,5		30	40	84	9,5
4,2		17	22	55	4,2	10		32	43	89	10
4,5		18	24	58	4,5	10,5		32	43	89	10,5
4,7		18	24	58	4,7	11		34	47	95	11
5		20	26	62	5	11,5		34	47	95	11,5
5,3		20	26	62	5,3	12		35	51	102	12
5,5		20	28	66	5,5	13		35	51	102	13
5,8		20	28	66	5,8	14		37	54	107	14
6		20	28	66	6	15		38	56	111	15
6,5		22	31	70	6,5	16		38	58	115	16

Für Zwischenabmessungen Preis auf Anfrage
For intermediate sizes price on request

Bestellbeispiel / Order example: 30-1320-7

Superdrill
superdrill



HAM Superdrill – besonders gut geeignet für den Einsatz in Stahl.

HAM Superdrill – spiral fluted drills especially for the machining of steel.

HAM 30-1621
Superdrill

Vollhartmetall-Spiralbohrer **3 x D**
solid carbide spiral drill

VHM	Z 2	30° rechts	DIN 6537 K
3 x D	Typ Werk	140°	DIN 6535 HA
HSF	HPC	SHRINK FIT	
DIN 6535 HB	DIN 6535 HE		

- Konstruktions-Daten**
- spezielle Schneidkantenverrundung
 - spezielle Spankammergeometrie
 - verstärkter Kern
 - Spiralwinkel 30°

- Engineering data**
- special point ground
 - special chip flute geometry
 - reinforced web thickness
 - 30° RH helix

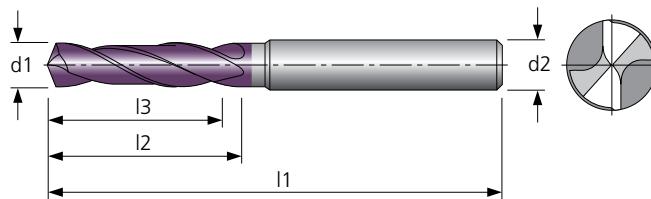

Material	Alu Knet-leg.	Alu Guss-leg.	Stahl < 800 N/mm²	Stahl < 1200 N/mm²	Stahl < 1600 N/mm²	Stahl < 55 HRC	Stahl < 60 HRC	Stahl < 66 HRC	INOX < 800 N/mm²	INOX > 800 N/mm²	GG	GGG	hochw. Legierungen	Titan	NE-Metalle Cu-Leg.	Graphit & Faser-verbund	MMS	max.	ohne	AIR
30-1621			●	●	●	●			○	○	●	●	○	○			●	●	○	○

Schnittdaten siehe Seite / cutting data available on page – 163

● sehr gut geeignet / very suitable ○ bedingt geeignet / limited suitable

Ø d1 (m7) mm	30-1621	l3 mm	l2 mm	l1 mm	Ø d2 (h6) mm	Ø d1 (m7) mm	30-1621	l3 mm	l2 mm	l1 mm	Ø d2 (h6) mm
	TA-C						TA-C				
2,8		14	20	62	6	6,1		24	34	79	8
3		14	20	62	6	6,2		24	34	79	8
3,2		14	20	62	6	6,3		24	34	79	8
3,25		14	20	62	6	6,4		24	34	79	8
3,3		14	20	62	6	6,5		24	34	79	8
3,4		14	20	62	6	6,6		24	34	79	8
3,5		14	20	62	6	6,7		24	34	79	8
3,6		14	20	62	6	6,8		24	34	79	8
3,7		14	20	62	6	6,9		24	34	79	8
3,8		17	24	66	6	7		24	34	79	8
3,9		17	24	66	6	7,2		29	41	79	8
4		17	24	66	6	7,4		29	41	79	8
4,2		17	24	66	6	7,5		29	41	79	8
4,3		17	24	66	6	7,8		29	41	79	8
4,5		17	24	66	6	7,9		29	41	79	8
4,65		17	24	66	6	8		29	41	79	8
4,8		20	28	66	6	8,1		35	47	89	10
4,9		20	28	66	6	8,2		35	47	89	10
5		20	28	66	6	8,3		35	47	89	10
5,1		20	28	66	6	8,4		35	47	89	10
5,2		20	28	66	6	8,5		35	47	89	10
5,3		20	28	66	6	8,6		35	47	89	10
5,4		20	28	66	6	8,7		35	47	89	10
5,5		20	28	66	6	8,8		35	47	89	10
5,55		20	28	66	6	8,9		35	47	89	10
5,6		20	28	66	6	9		35	47	89	10
5,7		20	28	66	6	9,3		35	47	89	10
5,8		20	28	66	6	9,5		35	47	89	10
5,9		20	28	66	6	9,8		35	47	89	10
6		20	28	66	6	10		35	47	89	10

Für Zwischenabmessungen Preis auf Anfrage
For intermediate sizes price on request

Bestellbeispiel / Order example: HA-Schaft /shank 30-1621-6,1
HB-Schaft /shank 30-1621-6,1-HB
HE-Schaft /shank 30-1621-6,1-HE

Ø d1 (m7) mm	30-1621	l3 mm	l2 mm	l1 mm	Ø d2 (h6) mm
	TA-C				
10,2		40	55	102	12
10,3		40	55	102	12
10,4		40	55	102	12
10,5		40	55	102	12
11		40	55	102	12
11,2		40	55	102	12
11,5		40	55	102	12
11,8		40	55	102	12
12		40	55	102	12
12,5		43	60	107	14
12,8		43	60	107	14
13		43	60	107	14
13,5		43	60	107	14
13,8		43	60	107	14
14		43	60	107	14

Für Zwischenabmessungen Preis auf Anfrage
For intermediate sizes price on request

Ø d1 (m7) mm	30-1621	l3 mm	l2 mm	l1 mm	Ø d2 (h6) mm
	TA-C				
14,5		45	65	115	16
14,8		45	65	115	16
15		45	65	115	16
15,5		45	65	115	16
15,8		45	65	115	16
16		45	65	115	16
16,5		51	73	123	18
17		51	73	123	18
17,5		51	73	123	18
18		51	73	123	18
18,5		55	79	131	20
19		55	79	131	20
19,5		55	79	131	20
20		55	79	131	20

Bestellbeispiel / Order example: HA-Schaft /shank 30-1621-14,5
HB-Schaft /shank 30-1621-14,5-HB
HE-Schaft /shank 30-1621-14,5-HE

HAM 30-1701
Superdrill

Vollhartmetall-Spiralbohrer **5 x D**
solid carbide spiral drill

VHM	Z 2	30° rechts	DIN 6537
5 x D	Typ Werk	140°	DIN 6535 HA
HSF	HPC	SHRINK FIT	
DIN 6535 HB	DIN 6535 HE		

- Konstruktions-Daten**
- spezielle Schneidkantenverrundung
 - spezielle Spankammergeometrie
 - verstärkter Kern
 - Spiralwinkel 30°

- Engineering data**
- special point ground
 - special chip flute geometry
 - reinforced web thickness
 - 30° RH helix

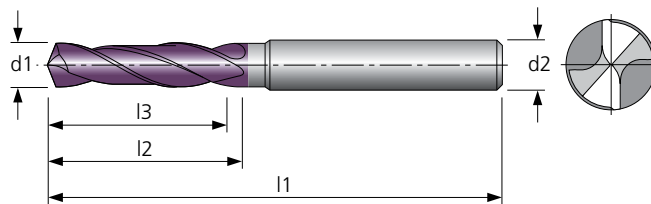

Material	Alu Knet-leg.	Alu Guss-leg.	Stahl < 800 N/mm²	Stahl < 1200 N/mm²	Stahl < 1600 N/mm²	Stahl < 55 HRC	Stahl < 60 HRC	Stahl < 66 HRC	INOX < 800 N/mm²	INOX > 800 N/mm²	GG	GGG	hochw. Legierungen	Titan	NE-Metalle Cu-Leg.	Graphit & Faser-verbund	MMS	max.	ohne	AIR
30-1701			●	●	●	●			○	○	●	●	○	○			●	●	○	○

Schnittdaten siehe Seite / cutting data available on page – 163

● sehr gut geeignet / very suitable ○ bedingt geeignet / limited suitable

Ø d1 (m7) mm	30-1701	l3 mm	l2 mm	l1 mm	Ø d2 (h6) mm	Ø d1 (m7) mm	30-1701	l3 mm	l2 mm	l1 mm	Ø d2 (h6) mm
	TA-C						TA-C				
3		23	28	66	6	6,5		43	53	91	8
3,1		23	28	66	6	6,6		43	53	91	8
3,2		23	28	66	6	6,7		43	53	91	8
3,3		23	28	66	6	6,8		43	53	91	8
3,4		23	28	66	6	6,9		43	53	91	8
3,5		23	28	66	6	7		43	53	91	8
3,6		23	28	66	6	7,1		43	53	91	8
3,7		23	28	66	6	7,2		43	53	91	8
3,8		29	36	74	6	7,3		43	53	91	8
3,9		29	36	74	6	7,4		43	53	91	8
4		29	36	74	6	7,5		43	53	91	8
4,1		29	36	74	6	7,6		43	53	91	8
4,2		29	36	74	6	7,7		43	53	91	8
4,3		29	36	74	6	7,8		43	53	91	8
4,4		29	36	74	6	7,9		43	53	91	8
4,5		29	36	74	6	8		43	53	91	8
4,6		29	36	74	6	8,1		49	61	103	10
4,7		29	36	74	6	8,2		49	61	103	10
4,8		35	44	82	6	8,3		49	61	103	10
4,9		35	44	82	6	8,4		49	61	103	10
5		35	44	82	6	8,5		49	61	103	10
5,1		35	44	82	6	8,6		49	61	103	10
5,2		35	44	82	6	8,7		49	61	103	10
5,3		35	44	82	6	8,8		49	61	103	10
5,4		35	44	82	6	8,9		49	61	103	10
5,5		35	44	82	6	9		49	61	103	10
5,6		35	44	82	6	9,1		49	61	103	10
5,7		35	44	82	6	9,2		49	61	103	10
5,8		35	44	82	6	9,3		49	61	103	10
5,9		35	44	82	6	9,4		49	61	103	10
6		35	44	82	6	9,5		49	61	103	10
6,1		43	53	91	8	9,6		49	61	103	10
6,2		43	53	91	8	9,7		49	61	103	10
6,3		43	53	91	8	9,8		49	61	103	10
6,4		43	53	91	8	9,9		49	61	103	10

Für Zwischenabmessungen Preis auf Anfrage
For intermediate sizes price on request

Bestellbeispiel / Order example: HA-Schaft /shank 30-1701-6,5
HB-Schaft /shank 30-1701-6,5-HB
HE-Schaft /shank 30-1701-6,5-HE

Ø d1 (m7) mm	30-1701	l3 mm	l2 mm	l1 mm	Ø d2 (h6) mm
	TA-C				
10		49	61	103	10
10,1		56	71	118	12
10,2		56	71	118	12
10,3		56	71	118	12
10,4		56	71	118	12
10,5		56	71	118	12
10,6		56	71	118	12
10,7		56	71	118	12
10,8		56	71	118	12
10,9		56	71	118	12
11		56	71	118	12
11,1		56	71	118	12
11,2		56	71	118	12
11,3		56	71	118	12
11,4		56	71	118	12
11,5		56	71	118	12
11,6		56	71	118	12
11,7		56	71	118	12
11,8		56	71	118	12
11,9		56	71	118	12

Für Zwischenabmessungen Preis auf Anfrage
For intermediate sizes price on request

Ø d1 (m7) mm	30-1701	l3 mm	l2 mm	l1 mm	Ø d2 (h6) mm
	TA-C				
12		56	71	118	12
12,1		60	77	124	14
12,2		60	77	124	14
12,5		60	77	124	14
12,8		60	77	124	14
13		60	77	124	14
13,5		60	77	124	14
13,8		60	77	124	14
14		60	77	124	14
14,5		63	83	133	16
14,8		63	83	133	16
15		63	83	133	16
15,5		63	83	133	16
15,8		63	83	133	16
16		63	83	133	16

Bestellbeispiel / Order example: HA-Schaft /shank 30-1701-12
HB-Schaft /shank 30-1701-12-HB
HE-Schaft /shank 30-1701-12-HE

HAM 30-1741
Superdrill

Vollhartmetall-Spiralbohrer **3 x D**
solid carbide spiral drill

VHM	Z 2	30° rechts	DIN 6537 K
3 x D	Typ Werk	140°	DIN 6535 HAK
HSF	HPC	SHRINK FIT	
	DIN 6535 HBK	DIN 6535 HEK	

- Konstruktions-Daten**
- spezielle Schneidkantenverrundung
 - spezielle Spankammergeometrie
 - verstärkter Kern
 - Spiralwinkel 30°

- Engineering data**
- special point ground
 - special chip flute geometry
 - reinforced web thickness
 - 30° RH helix

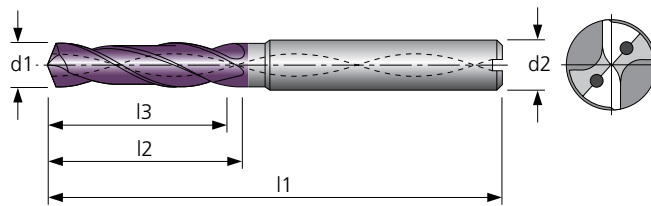

Material	Alu Knet-leg.	Alu Guss-leg.	Stahl < 800 N/mm²	Stahl < 1200 N/mm²	Stahl < 1600 N/mm²	Stahl < 55 HRC	Stahl < 60 HRC	Stahl < 66 HRC	INOX < 800 N/mm²	INOX > 800 N/mm²	GG	GGG	hochw. Legierungen	Titan	NE-Metalle Cu-Leg.	Graphit & Faser-verbund	MMS	max.	ohne	AIR
30-1741			●	●	●	●			○	○	●	●	○	○			●	●	○	○

Schnittdaten siehe Seite / cutting data available on page - 164

● sehr gut geeignet / very suitable ○ bedingt geeignet / limited suitable

Ø d1 (m7) mm	30-1741	l3 mm	l2 mm	l1 mm	Ø d2 (h6) mm	Ø d1 (m7) mm	30-1741	l3 mm	l2 mm	l1 mm	Ø d2 (h6) mm
	TA-C						TA-C				
3		14	20	62	6	6,5		24	34	79	8
3,1		14	20	62	6	6,6		24	34	79	8
3,2		14	20	62	6	6,7		24	34	79	8
3,3		14	20	62	6	6,8		24	34	79	8
3,4		14	20	62	6	6,9		24	34	79	8
3,5		14	20	62	6	7		24	34	79	8
3,6		14	20	62	6	7,1		29	41	79	8
3,7		14	20	62	6	7,2		29	41	79	8
3,8		17	24	66	6	7,3		29	41	79	8
3,9		17	24	66	6	7,4		29	41	79	8
4		17	24	66	6	7,5		29	41	79	8
4,1		17	24	66	6	7,6		29	41	79	8
4,2		17	24	66	6	7,7		29	41	79	8
4,3		17	24	66	6	7,8		29	41	79	8
4,4		17	24	66	6	7,9		29	41	79	8
4,5		17	24	66	6	8		29	41	79	8
4,6		17	24	66	6	8,1		35	47	89	10
4,7		17	24	66	6	8,2		35	47	89	10
4,8		20	28	66	6	8,3		35	47	89	10
4,9		20	28	66	6	8,4		35	47	89	10
5		20	28	66	6	8,5		35	47	89	10
5,1		20	28	66	6	8,6		35	47	89	10
5,2		20	28	66	6	8,7		35	47	89	10
5,3		20	28	66	6	8,8		35	47	89	10
5,4		20	28	66	6	8,9		35	47	89	10
5,5		20	28	66	6	9		35	47	89	10
5,6		20	28	66	6	9,1		35	47	89	10
5,7		20	28	66	6	9,2		35	47	89	10
5,8		20	28	66	6	9,3		35	47	89	10
5,9		20	28	66	6	9,4		35	47	89	10
6		20	28	66	6	9,5		35	47	89	10
6,1		24	34	79	8	9,6		35	47	89	10
6,2		24	34	79	8	9,7		35	47	89	10
6,3		24	34	79	8	9,8		35	47	89	10
6,4		24	34	79	8	9,9		35	47	89	10

Für Zwischenabmessungen Preis auf Anfrage
For intermediate sizes price on request

Bestellbeispiel / Order example: HAK-Schaft /shank 30-1741-6,5
HBK-Schaft /shank 30-1741-6,5-HBK
HEK-Schaft /shank 30-1741-6,5-HEK

Ø d1 (m7) mm	30-1741	l3 mm	l2 mm	l1 mm	Ø d2 (h6) mm
	TA-C				
10		35	47	89	10
10,1		40	55	102	12
10,2		40	55	102	12
10,3		40	55	102	12
10,4		40	55	102	12
10,5		40	55	102	12
10,6		40	55	102	12
10,7		40	55	102	12
10,8		40	55	102	12
10,9		40	55	102	12
11		40	55	102	12
11,2		40	55	102	12
11,5		40	55	102	12
11,8		40	55	102	12
12		40	55	102	12
12,5		43	60	107	14
12,7		43	60	107	14
12,8		43	60	107	14
13		43	60	107	14
13,5		43	60	107	14

Für Zwischenabmessungen Preis auf Anfrage
For intermediate sizes price on request

Ø d1 (m7) mm	30-1741	l3 mm	l2 mm	l1 mm	Ø d2 (h6) mm
	TA-C				
13,8		43	60	107	14
14		43	60	107	14
14,5		45	65	115	16
14,8		45	65	115	16
15		45	65	115	16
15,5		45	65	115	16
15,8		45	65	115	16
16		45	65	115	16
16,5		51	73	123	18
17		51	73	123	18
17,5		51	73	123	18
18		51	73	123	18
18,5		55	79	131	20
19		55	79	131	20
19,5		55	79	131	20
20		55	79	131	20
22		75	105	165	25

Bestellbeispiel / Order example: HAK-Schaft /shank 30-1741-13,8
HBK-Schaft /shank 30-1741-13,8-HBK
HEK-Schaft /shank 30-1741-13,8-HEK

HAM 30-1781
Superdrill

Vollhartmetall-Spiralbohrer **5 x D**
solid carbide spiral drill

VHM	Z 2	30° rechts	DIN 6537
5 x D	Typ Werk	140°	DIN 6535 HAK
HSF	HPC	SHRINK FIT	
	DIN 6535 HBK	DIN 6535 HEK	

- Konstruktions-Daten**
- spezielle Schneidkantenverrundung
 - spezielle Spankammergeometrie
 - verstärkter Kern
 - Spiralwinkel 30°

- Engineering data**
- special point ground
 - special chip flute geometry
 - reinforced web thickness
 - 30° RH helix

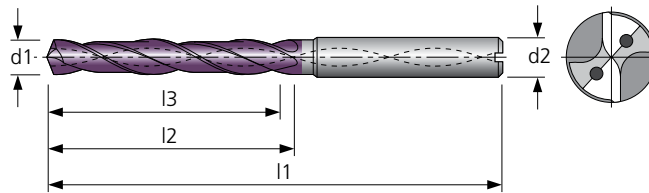

Material	Alu Knet-leg.	Alu Guss-leg.	Stahl < 800 N/mm²	Stahl < 1200 N/mm²	Stahl < 1600 N/mm²	Stahl < 55 HRC	Stahl < 60 HRC	Stahl < 66 HRC	INOX < 800 N/mm²	INOX > 800 N/mm²	GG	GGG	hochw. Legierungen	Titan	NE-Metalle Cu-Leg.	Graphit & Faser-verbund	MMS	max.	ohne	AIR
30-1781			●	●	●	●			○	○	●	●	○	○			●	●	○	○

Schnittdaten siehe Seite / cutting data available on page - 164

● sehr gut geeignet / very suitable ○ bedingt geeignet / limited suitable

Ø d1 (m7) mm	30-1781	l3 mm	l2 mm	l1 mm	Ø d2 (h6) mm	Ø d1 (m7) mm	30-1781	l3 mm	l2 mm	l1 mm	Ø d2 (h6) mm
	TA-C						TA-C				
3		23	28	66	6	6,2		43	53	91	8
3,1		23	28	66	6	6,3		43	53	91	8
3,2		23	28	66	6	6,4		43	53	91	8
3,25		23	28	66	6	6,5		43	53	91	8
3,3		23	28	66	6	6,6		43	53	91	8
3,4		23	28	66	6	6,7		43	53	91	8
3,5		23	28	66	6	6,8		43	53	91	8
3,6		23	28	66	6	6,9		43	53	91	8
3,7		23	28	66	6	7		43	53	91	8
3,8		29	36	74	6	7,1		43	53	91	8
3,9		29	36	74	6	7,2		43	53	91	8
4		29	36	74	6	7,3		43	53	91	8
4,1		29	36	74	6	7,4		43	53	91	8
4,2		29	36	74	6	7,5		43	53	91	8
4,3		29	36	74	6	7,6		43	53	91	8
4,4		29	36	74	6	7,7		43	53	91	8
4,5		29	36	74	6	7,8		43	53	91	8
4,6		29	36	74	6	7,9		43	53	91	8
4,65		29	36	74	6	8		43	53	91	8
4,7		29	36	74	6	8,1		49	61	103	10
4,8		35	44	82	6	8,2		49	61	103	10
4,9		35	44	82	6	8,3		49	61	103	10
5		35	44	82	6	8,4		49	61	103	10
5,1		35	44	82	6	8,5		49	61	103	10
5,2		35	44	82	6	8,6		49	61	103	10
5,3		35	44	82	6	8,7		49	61	103	10
5,4		35	44	82	6	8,8		49	61	103	10
5,5		35	44	82	6	8,9		49	61	103	10
5,55		35	44	82	6	9		49	61	103	10
5,6		35	44	82	6	9,1		49	61	103	10
5,7		35	44	82	6	9,2		49	61	103	10
5,8		35	44	82	6	9,3		49	61	103	10
5,9		35	44	82	6	9,4		49	61	103	10
6		35	44	82	6	9,5		49	61	103	10
6,1		43	53	91	8	9,6		49	61	103	10

Für Zwischenabmessungen Preis auf Anfrage
For intermediate sizes price on request

Bestellbeispiel / Order example: HAK-Schaft /shank 30-1781-6,2
HBK-Schaft /shank 30-1781-6,2-HBK
HEK-Schaft /shank 30-1781-6,2-HEK

Ø d1 (m7) mm	30-1781	l3 mm	l2 mm	l1 mm	Ø d2 (h6) mm
	TA-C				
9,7		49	61	103	10
9,8		49	61	103	10
9,9		49	61	103	10
10		49	61	103	10
10,1		56	71	118	12
10,2		56	71	118	12
10,3		56	71	118	12
10,4		56	71	118	12
10,5		56	71	118	12
10,6		56	71	118	12
10,7		56	71	118	12
10,8		56	71	118	12
10,9		56	71	118	12
11		56	71	118	12
11,2		56	71	118	12
11,5		56	71	118	12
11,8		56	71	118	12
12		56	71	118	12
12,1		60	77	124	14
12,2		60	77	124	14
12,3		60	77	124	14
12,4		60	77	124	14

Für Zwischenabmessungen Preis auf Anfrage
For intermediate sizes price on request

Ø d1 (m7) mm	30-1781	l3 mm	l2 mm	l1 mm	Ø d2 (h6) mm
	TA-C				
12,5		60	77	124	14
12,7		60	77	124	14
12,8		60	77	124	14
13		60	77	124	14
13,5		60	77	124	14
13,8		60	77	124	14
14		60	77	124	14
14,5		63	83	133	16
14,8		63	83	133	16
15		63	83	133	16
15,1		63	83	133	16
15,5		63	83	133	16
15,8		63	83	133	16
16		63	83	133	16
16,5		71	93	143	18
17		71	93	143	18
17,5		71	93	143	18
18		71	93	143	18
18,5		77	101	153	20
19		77	101	153	20
19,5		77	101	153	20
20		77	101	153	20

Bestellbeispiel / Order example: HAK-Schaft/shank 30-1781-12,5
HBK-Schaft/shank 30-1781-12,5-HBK
HEK-Schaft/shank 30-1781-12,5-HEK

HAM 30-1821
Superdrill

Vollhartmetall-Spiralbohrer **8 x D**
solid carbide spiral drill

VHM	Z 2	30° rechts	Werk Norm
8 x D	Typ Werk	140°	DIN 6535 HAK
HSF	HPC	SHRINK FIT	
	DIN 6535 HBK	DIN 6535 HEK	

- Konstruktions-Daten**
- spezielle Schneidkantenverrundung
 - spezielle Spankammergeometrie
 - verstärkter Kern
 - Spiralwinkel 30°

- Engineering data**
- special point ground
 - special chip flute geometry
 - reinforced web thickness
 - 30° RH helix

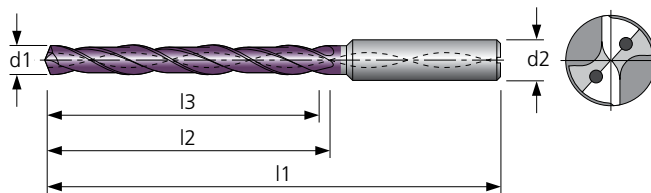

Material	Alu Knet-leg.	Alu Guss-leg.	Stahl < 800 N/mm²	Stahl < 1200 N/mm²	Stahl < 1600 N/mm²	Stahl < 55 HRC	Stahl < 60 HRC	Stahl < 66 HRC	INOX < 800 N/mm²	INOX > 800 N/mm²	GG	GGG	hochw. Legierungen	Titan	NE-Metalle Cu-Leg.	Graphit & Faser-verbund	MMS	max.	ohne	AIR
30-1821			●	●	●	●			○	○	●	●	○	○			●	●	○	○

Schnittdaten siehe Seite / cutting data available on page - 164

● sehr gut geeignet / very suitable ○ bedingt geeignet / limited suitable

Ø d1 (m7) mm	30-1821	l3 mm	l2 mm	l1 mm	Ø d2 (h6) mm	Ø d1 (m7) mm	30-1821	l3 mm	l2 mm	l1 mm	Ø d2 (h6) mm
	TA-C						TA-C				
3		29	34	72	6	7		64	76	114	8
3,1		29	34	72	6	7,5		64	76	114	8
3,2		29	34	72	6	7,8		64	76	114	8
3,3		29	34	72	6	8		64	76	114	8
3,4		29	34	72	6	8,5		80	95	142	10
3,5		29	34	72	6	9		80	95	142	10
3,6		29	34	72	6	9,5		80	95	142	10
3,7		29	34	72	6	10		80	95	142	10
3,8		36	43	81	6	10,2		96	114	162	12
3,9		36	43	81	6	10,5		96	114	162	12
4		36	43	81	6	11		96	114	162	12
4,1		36	43	81	6	11,5		96	114	162	12
4,2		36	43	81	6	12		96	114	162	12
4,3		36	43	81	6	12,5		112	131	178	14
4,4		36	43	81	6	13		112	131	178	14
4,5		36	43	81	6	13,5		112	131	178	14
4,6		36	43	81	6	14		112	131	178	14
4,7		36	43	81	6	14,5		128	152	203	16
4,8		48	57	95	6	15		128	152	203	16
4,9		48	57	95	6	15,5		128	152	203	16
5		48	57	95	6	16		128	152	203	16
5,5		48	57	95	6	16,5		144	171	222	18
6		48	57	95	6	17		144	171	222	18
6,5		64	76	114	8	17,5		144	171	222	18
6,8		64	76	114	8	18		144	171	222	18

Für Zwischenabmessungen Preis auf Anfrage
For intermediate sizes price on request

Bestellbeispiel / Order example: HAK-Schaft /shank 30-1821-7
HBK-Schaft /shank 30-1821-7-HBK
HEK-Schaft /shank 30-1821-7-HEK

HAM 30-1861
Superdrill

Vollhartmetall-Spiralbohrer **12 x D**
solid carbide spiral drill

VHM	Z 2	30° rechts	Werk Norm
12 x D	Typ Werk	140°	DIN 6535 HAK
HSF	HPC	SHRINK FIT	DIN 6535 HBK
			DIN 6535 HEK

Konstruktions-Daten

- 4 Führungsfasen
- spezielle Schneidkantenverrundung
- spezielle Spankammergeometrie
- verstärkter Kern
- Spiralwinkel 30°

Engineering data

- 4 guide chamfer
- special point ground
- special chip flute geometry
- reinforced web thickness
- 30° RH helix

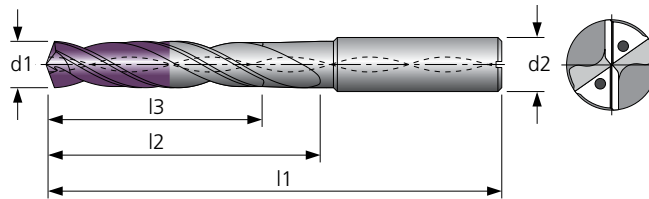

Material	Alu Knet-leg.	Alu Guss-leg.	Stahl < 800 N/mm²	Stahl < 1200 N/mm²	Stahl < 1600 N/mm²	Stahl < 55 HRC	Stahl < 60 HRC	Stahl < 66 HRC	INOX < 800 N/mm²	INOX > 800 N/mm²	GG	GGG	hochw. Legierungen	Titan	NE-Metalle Cu-Leg.	Graphit & Faser-verbund	MMS	max.	ohne	AIR
30-1861			●	●	●	●			○	○	●	●	○	○			●	●	○	○

Schnittdaten siehe Seite / cutting data available on page - 165

● sehr gut geeignet / very suitable ○ bedingt geeignet / limited suitable

Ø d1 (h7) mm	30-1861	l3 mm	l2 mm	l1 mm	Ø d2 (h6) mm	Ø d1 (h7) mm	30-1861	l3 mm	l2 mm	l1 mm	Ø d2 (h6) mm
	TA-C						TA-C				
3		48	54	92	6	7,7		94	108	146	8
3,3		48	54	92	6	8		94	108	146	8
3,5		48	54	92	6	8,1		110	120	162	10
3,8		58	64	102	6	8,2		110	120	162	10
4		58	64	102	6	8,4		110	120	162	10
4,2		58	64	102	6	9		110	120	162	10
4,5		58	64	102	6	9,8		110	120	162	10
4,8		70	78	116	6	10		110	120	162	10
5		70	78	116	6	10,5		142	156	204	12
5,5		70	78	116	6	11,2		142	156	204	12
6		70	78	116	6	12		142	156	204	12
6,5		94	108	146	8						
6,6		94	108	146	8						
6,8		94	108	146	8						
7		94	108	146	8						

Für Zwischenabmessungen Preis auf Anfrage
For intermediate sizes price on request

Bestellbeispiel / Order example: HAK-Schaft /shank 30-1861-7,7
HBK-Schaft /shank 30-1861-7,7-HBK
HEK-Schaft /shank 30-1861-7,7-HEK

Multidrill

Multidrill



HAM Multidrill

Gerne bieten wir Ihnen unsere Vollhartmetall-Multidrill als Sonderwerkzeuge auf Anfrage an.

HAM Multidrill

We are pleased to offer you our solid carbide Multidrill as special tools on request.

Für weitere Informationen stehen wir Ihnen gerne zur Verfügung.
For further information please do not hesitate to contact us.

Nirodrill

nirodrill



HAM Nirodrill – besonders gut geeignet für den Einsatz in rostfreiem Stahl.

HAM Nirodrill – spiral fluted drills especially for the machining of stainless steel.

HAM 30-1881
Nirodrill

Vollhartmetall-Spiralbohrer **3 x D**
solid carbide spiral drill

VHM	Z 2	30° rechts	DIN 6537 K
3 x D	Typ Werk	140°	DIN 6535 HAK
HSF	HPC	SHRINK FIT	
	DIN 6535 HBK	DIN 6535 HEK	

Konstruktions-Daten

- spezielle Spankammergeometrie
- Sonderanschliff zur Bearbeitung von nichtrostenden Stählen
- Spiralwinkel 30°

Engineering data

- special chip flute geometry
- special point ground for machining of stainless steel
- 30° RH helix

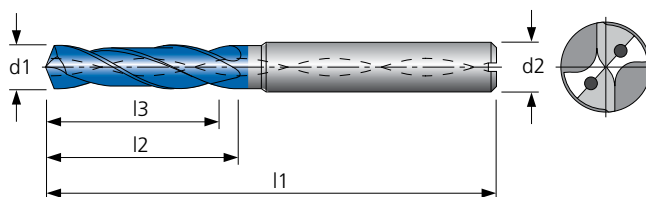

Material	Alu Knet-leg.	Alu Guss-leg.	Stahl < 800 N/mm²	Stahl < 1200 N/mm²	Stahl < 1600 N/mm²	Stahl < 55 HRC	Stahl < 60 HRC	Stahl < 66 HRC	INOX < 800 N/mm²	INOX > 800 N/mm²	GG	GGG	hochw. Legierungen	Titan	NE-Metalle Cu-Leg.	Graphit & Faserverbund	MMS	max.	ohne	AIR
30-1881	●	●							●	●	○		○	●	●	○	●	●		○

Schnittdaten siehe Seite / cutting data available on page – 167

● sehr gut geeignet / very suitable ○ bedingt geeignet / limited suitable

Ø d1 (m7) mm	30-1881	l3 mm	l2 mm	l1 mm	Ø d2 (h6) mm
	TA-CN				
3		14	20	62	6
3,2		14	20	62	6
3,3		14	20	62	6
3,5		14	20	62	6
3,8		17	24	66	6
4		17	24	66	6
4,2		17	24	66	6
4,5		17	24	66	6
4,8		20	28	66	6
5		20	28	66	6
5,5		20	28	66	6
5,8		20	28	66	6
6		20	28	66	6
6,5		24	34	79	8
6,8		24	34	79	8

Ø d1 (m7) mm	30-1881	l3 mm	l2 mm	l1 mm	Ø d2 (h6) mm
	TA-CN				
7		24	34	79	8
7,5		29	41	79	8
7,8		29	41	79	8
8		29	41	79	8
8,5		35	47	89	10
8,8		35	47	89	10
9		35	47	89	10
9,8		35	47	89	10
10		35	47	89	10
10,2		40	55	102	12
10,8		40	55	102	12
11,8		40	55	102	12
12		40	55	102	12
14		43	60	107	14

Für Zwischenabmessungen Preis auf Anfrage
For intermediate sizes price on request

Bestellbeispiel / Order example: HAK-Schaft /shank 30-1881-7
HBK-Schaft /shank 30-1881-7-HBK
HEK-Schaft /shank 30-1881-7-HEK

HAM 30-1891

Nirodrill

Vollhartmetall-Spiralbohrer 3 x D solid carbide spiral drill

VHM	Z 2	30° rechts	Werk Norm
3 x D	Typ Werk	140°	DIN 6535 HA
HSF	HPC	SHRINK FIT	
	DIN 6535 HB	DIN 6535 HE	

Konstruktions-Daten

- spezielle Spankammergeometrie
- Sonderanschliff zur Bearbeitung von nichtrostenden Stählen
- Spiralwinkel 30°

Engineering data

- special chip flute geometry
- special point ground for machining of stainless steel
- 30° RH helix

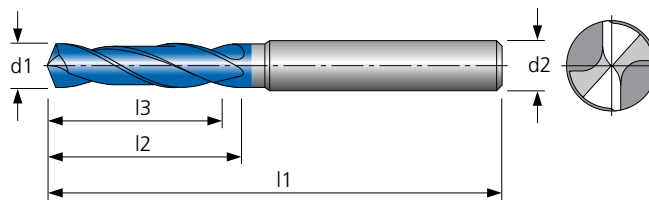

Material	Alu Knet-leg.	Alu Guss-leg.	Stahl < 800 N/mm²	Stahl < 1200 N/mm²	Stahl < 1600 N/mm²	Stahl < 55 HRC	Stahl < 60 HRC	Stahl < 66 HRC	INOX < 800 N/mm²	INOX > 800 N/mm²	GG	GGG	hochw. Legierungen	Titan	NE-Metalle Cu-Leg.	Graphit & Faser-verbund	MMS	max.	ohne	AIR
30-1891	●	●							●	●	○		○	●	●	○	●	●	○	○

Schnittdaten siehe Seite / cutting data available on page – 166

● sehr gut geeignet / very suitable ○ bedingt geeignet / limited suitable

Ø d1 (m7) mm	30-1891					Ø d1 (m7) mm	30-1891				
	TA-CN	l3 mm	l2 mm	l1 mm	Ø d2 (h6) mm		TA-CN	l3 mm	l2 mm	l1 mm	Ø d2 (h6) mm
2		10	14	46	4	6,9	24	34	79	8	
2,2		10	14	46	4	7	24	34	79	8	
2,3		10	14	46	4	7,4	29	41	79	8	
2,4		10	14	46	4	7,5	29	41	79	8	
2,5		10	14	46	4	7,8	29	41	79	8	
2,55		14	20	50	4	8	29	41	79	8	
2,7		14	20	50	4	8,5	35	47	89	10	
2,8		14	20	62	6	8,6	35	47	89	10	
3		14	20	62	6	8,8	35	47	89	10	
3,3		14	20	62	6	9	35	47	89	10	
3,4		14	20	62	6	9,3	35	47	89	10	
3,5		14	20	62	6	9,5	35	47	89	10	
3,7		14	20	62	6	9,8	35	47	89	10	
3,8		17	24	66	6	10	35	47	89	10	
4		17	24	66	6	10,2	40	55	102	12	
4,2		17	24	66	6	10,35	40	55	102	12	
4,3		17	24	66	6	10,5	40	55	102	12	
4,5		17	24	66	6	11	40	55	102	12	
4,65		17	24	66	6	11,2	40	55	102	12	
4,8		20	28	66	6	11,5	40	55	102	12	
5		20	28	66	6	11,8	40	55	102	12	
5,1		20	28	66	6	12	40	55	102	12	
5,5		20	28	66	6	13	43	60	107	14	
5,55		20	28	66	6	13,5	43	60	107	14	
5,8		20	28	66	6	13,8	43	60	107	14	
6		20	28	66	6	14	43	60	107	14	
6,2		24	34	79	8	15	45	65	115	16	
6,5		24	34	79	8	16	45	65	115	16	
6,6		24	34	79	8						
6,8		24	34	79	8						

Für Zwischenabmessungen Preis auf Anfrage
For intermediate sizes price on request

Bestellbeispiel / Order example: HA-Schaft /shank 30-1891-6,9
HB-Schaft /shank 30-1891-6,9-HB
HE-Schaft /shank 30-1891-6,9-HE

HAM 30-1901

Nirodrill

Vollhartmetall-Spiralbohrer 5 x D solid carbide spiral drill

VHM	Z 2	30° rechts	DIN 6537
5 x D	Typ Werk	140°	DIN 6535 HAK
HSF	HPC	SHRINK FIT	
	DIN 6535 HBK	DIN 6535 HEK	

Konstruktions-Daten

- spezielle Spankammergeometrie
- Sonderanschliff zur Bearbeitung von nichtrostenden Stählen
- Spiralwinkel 30°

Engineering data

- special chip flute geometry
- special point ground for machining of stainless steel
- 30° RH helix

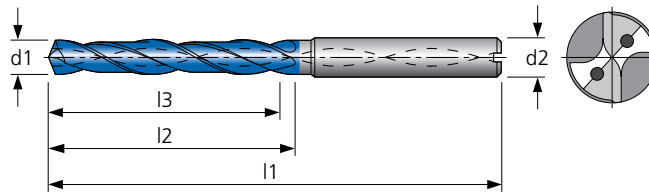

Material	Alu Knet-leg.	Alu Guss-leg.	Stahl < 800 N/mm²	Stahl < 1200 N/mm²	Stahl < 1600 N/mm²	Stahl < 55 HRC	Stahl < 60 HRC	Stahl < 66 HRC	INOX < 800 N/mm²	INOX > 800 N/mm²	GG	GGG	hochw. Legierungen	Titan	NE-Metalle Cu-Leg.	Graphit & Faserverbund	MMS	max.	ohne	AIR
30-1901	●	●							●	●	○		○	●	●	○	●	●		○

Schnittdaten siehe Seite / cutting data available on page - 167

● sehr gut geeignet / very suitable ○ bedingt geeignet / limited suitable

Ø d1 (m7) mm	30-1901					Ø d1 (m7) mm	30-1901				
	TA-CN	l3 mm	l2 mm	l1 mm	Ø d2 (h6) mm		TA-CN	l3 mm	l2 mm	l1 mm	Ø d2 (h6) mm
3		23	28	66	6	6,3	43	53	91	8	
3,1		23	28	66	6	6,4	43	53	91	8	
3,2		23	28	66	6	6,5	43	53	91	8	
3,3		23	28	66	6	6,6	43	53	91	8	
3,4		23	28	66	6	6,7	43	53	91	8	
3,5		23	28	66	6	6,8	43	53	91	8	
3,6		23	28	66	6	6,9	43	53	91	8	
3,7		23	28	66	6	7	43	53	91	8	
3,8		29	36	74	6	7,1	43	53	91	8	
3,9		29	36	74	6	7,2	43	53	91	8	
4		29	36	74	6	7,3	43	53	91	8	
4,1		29	36	74	6	7,4	43	53	91	8	
4,2		29	36	74	6	7,5	43	53	91	8	
4,3		29	36	74	6	7,6	43	53	91	8	
4,4		29	36	74	6	7,7	43	53	91	8	
4,5		29	36	74	6	7,8	43	53	91	8	
4,6		29	36	74	6	7,9	43	53	91	8	
4,65		29	36	74	6	8	43	53	91	8	
4,7		29	36	74	6	8,1	49	61	103	10	
4,8		35	44	82	6	8,2	49	61	103	10	
4,9		35	44	82	6	8,3	49	61	103	10	
5		35	44	82	6	8,4	49	61	103	10	
5,1		35	44	82	6	8,5	49	61	103	10	
5,2		35	44	82	6	8,6	49	61	103	10	
5,3		35	44	82	6	8,7	49	61	103	10	
5,4		35	44	82	6	8,8	49	61	103	10	
5,5		35	44	82	6	8,9	49	61	103	10	
5,55		35	44	82	6	9	49	61	103	10	
5,6		35	44	82	6	9,1	49	61	103	10	
5,7		35	44	82	6	9,2	49	61	103	10	
5,8		35	44	82	6	9,3	49	61	103	10	
5,9		35	44	82	6	9,4	49	61	103	10	
6		35	44	82	6	9,5	49	61	103	10	
6,1		43	53	91	8	9,6	49	61	103	10	
6,2		43	53	91	8	9,7	49	61	103	10	

Für Zwischenabmessungen Preis auf Anfrage
For intermediate sizes price on request

Bestellbeispiel / Order example: HAK-Schaft /shank 30-1901-6,3
HBK-Schaft /shank 30-1901-6,3-HBK
HEK-Schaft /shank 30-1901-6,3-HEK

Ø d1 (m7) mm	30-1901	l3 mm	l2 mm	l1 mm	Ø d2 (h6) mm
	TA-CN				
9,8		49	61	103	10
9,9		49	61	103	10
10		49	61	103	10
10,1		56	71	118	12
10,2		56	71	118	12
10,3		56	71	118	12
10,4		56	71	118	12
10,5		56	71	118	12
10,6		56	71	118	12
10,7		56	71	118	12
10,8		56	71	118	12
10,9		56	71	118	12
11		56	71	118	12
11,1		56	71	118	12
11,2		56	71	118	12
11,3		56	71	118	12
11,4		56	71	118	12
11,5		56	71	118	12

Für Zwischenabmessungen Preis auf Anfrage
For intermediate sizes price on request

Ø d1 (m7) mm	30-1901	l3 mm	l2 mm	l1 mm	Ø d2 (h6) mm
	TA-CN				
11,6		56	71	118	12
11,7		56	71	118	12
11,8		56	71	118	12
11,9		56	71	118	12
12		56	71	118	12
12,5		60	77	124	14
12,8		60	77	124	14
13		60	77	124	14
13,5		60	77	124	14
13,8		60	77	124	14
14		60	77	124	14
14,5		63	83	133	16
14,8		63	83	133	16
15		63	83	133	16
15,1		63	83	133	16
15,5		63	83	133	16
15,8		63	83	133	16
16		63	83	133	16

Bestellbeispiel / Order example: HAK-Schaft/shank 30-1901-11,6
HBK-Schaft/shank 30-1901-11,6-HBK
HEK-Schaft/shank 30-1901-11,6-HEK

HAM 30-1941

Nirodrill

Vollhartmetall-Spiralbohrer 8 x D solid carbide spiral drill

VHM	Z 2	30° rechts	Werk Norm
8 x D	Typ Werk	140°	DIN 6535 HAK
HSF	HPC	SHRINK FIT	DIN 6535 HBK
			DIN 6535 HEK

Konstruktions-Daten

- spezielle Spankammergeometrie
- Sonderanschliff zur Bearbeitung von nichtrostenden Stählen
- Spiralwinkel 30°

Engineering data

- special chip flute geometry
- special point ground for machining of stainless steel
- 30° RH helix

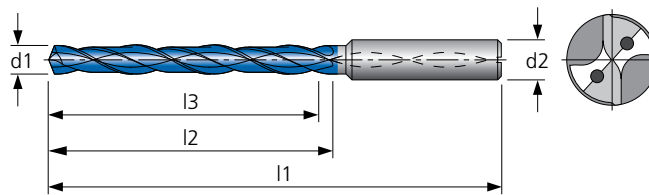

Material	Alu Knet-leg.	Alu Guss-leg.	Stahl < 800 N/mm²	Stahl < 1200 N/mm²	Stahl < 1600 N/mm²	Stahl < 55 HRC	Stahl < 60 HRC	Stahl < 66 HRC	INOX < 800 N/mm²	INOX > 800 N/mm²	GG	GGG	hochw. Legierungen	Titan	NE-Metalle Cu-Leg.	Graphit & Faser-verbund	MMS	max.	ohne	AIR
30-1941	●	●							●	●	○		○	●	●	○	●	●		○

Schnittdaten siehe Seite / cutting data available on page - 167

● sehr gut geeignet / very suitable ○ bedingt geeignet / limited suitable

Ø d1 (m7) mm	30-1941					Ø d2 (h6) mm	Ø d1 (m7) mm	30-1941					Ø d2 (h6) mm
	TA-CN	l3 mm	l2 mm	l1 mm	TA-CN			l3 mm	l2 mm	l1 mm			
3		29	34	72	6		6,5	64	76	114	8		
3,1		29	34	72	6		6,6	64	76	114	8		
3,2		29	34	72	6		6,7	64	76	114	8		
3,3		29	34	72	6		6,8	64	76	114	8		
3,4		29	34	72	6		6,9	64	76	114	8		
3,5		29	34	72	6		7	64	76	114	8		
3,6		29	34	72	6		7,1	64	76	114	8		
3,7		29	34	72	6		7,2	64	76	114	8		
3,8		36	43	81	6		7,3	64	76	114	8		
3,9		36	43	81	6		7,4	64	76	114	8		
4		36	43	81	6		7,5	64	76	114	8		
4,1		36	43	81	6		7,6	64	76	114	8		
4,2		36	43	81	6		7,7	64	76	114	8		
4,3		36	43	81	6		7,8	64	76	114	8		
4,4		36	43	81	6		7,9	64	76	114	8		
4,5		36	43	81	6		8	64	76	114	8		
4,6		36	43	81	6		8,1	80	95	142	10		
4,7		36	43	81	6		8,2	80	95	142	10		
4,8		48	57	95	6		8,3	80	95	142	10		
4,9		48	57	95	6		8,4	80	95	142	10		
5		48	57	95	6		8,5	80	95	142	10		
5,1		48	57	95	6		8,6	80	95	142	10		
5,2		48	57	95	6		8,7	80	95	142	10		
5,3		48	57	95	6		8,8	80	95	142	10		
5,4		48	57	95	6		8,9	80	95	142	10		
5,5		48	57	95	6		9	80	95	142	10		
5,6		48	57	95	6		9,1	80	95	142	10		
5,7		48	57	95	6		9,2	80	95	142	10		
5,8		48	57	95	6		9,3	80	95	142	10		
5,9		48	57	95	6		9,4	80	95	142	10		
6		48	57	95	6		9,5	80	95	142	10		
6,1		64	76	114	8		9,6	80	95	142	10		
6,2		64	76	114	8		9,7	80	95	142	10		
6,3		64	76	114	8		9,8	80	95	142	10		
6,4		64	76	114	8		9,9	80	95	142	10		

Für Zwischenabmessungen Preis auf Anfrage
For intermediate sizes price on request

Bestellbeispiel / Order example: HAK-Schaft /shank 30-1941-6,5
HBK-Schaft /shank 30-1941-6,5-HBK
HEK-Schaft /shank 30-1941-6,5-HEK

Ø d1 (m7) mm	30-1941	l3 mm	l2 mm	l1 mm	Ø d2 (h6) mm
	TA-CN				
10		80	95	142	10
10,1		96	114	162	12
10,2		96	114	162	12
10,3		96	114	162	12
10,4		96	114	162	12
10,5		96	114	162	12
10,6		96	114	162	12
10,7		96	114	162	12
10,8		96	114	162	12
10,9		96	114	162	12
11		96	114	162	12
11,1		96	114	162	12
11,2		96	114	162	12
11,3		96	114	162	12
11,4		96	114	162	12
11,5		96	114	162	12
11,6		96	114	162	12

Für Zwischenabmessungen Preis auf Anfrage
For intermediate sizes price on request

Ø d1 (m7) mm	30-1941	l3 mm	l2 mm	l1 mm	Ø d2 (h6) mm
	TA-CN				
11,7		96	114	162	12
11,8		96	114	162	12
11,9		96	114	162	12
12		96	114	162	12
12,5		112	131	178	14
12,8		112	131	178	14
13		112	131	178	14
13,5		112	131	178	14
13,8		112	131	178	14
14		112	131	178	14
14,5		128	152	203	16
14,8		128	152	203	16
15		128	152	203	16
15,5		128	152	203	16
15,8		128	152	203	16
16		128	152	203	16

Bestellbeispiel / Order example: HAK-Schaft/shank 30-1941-11,7
HBK-Schaft/shank 30-1941-11,7-HBK
HEK-Schaft/shank 30-1941-11,7-HEK

Moderne Werkstoffe

advanced materials

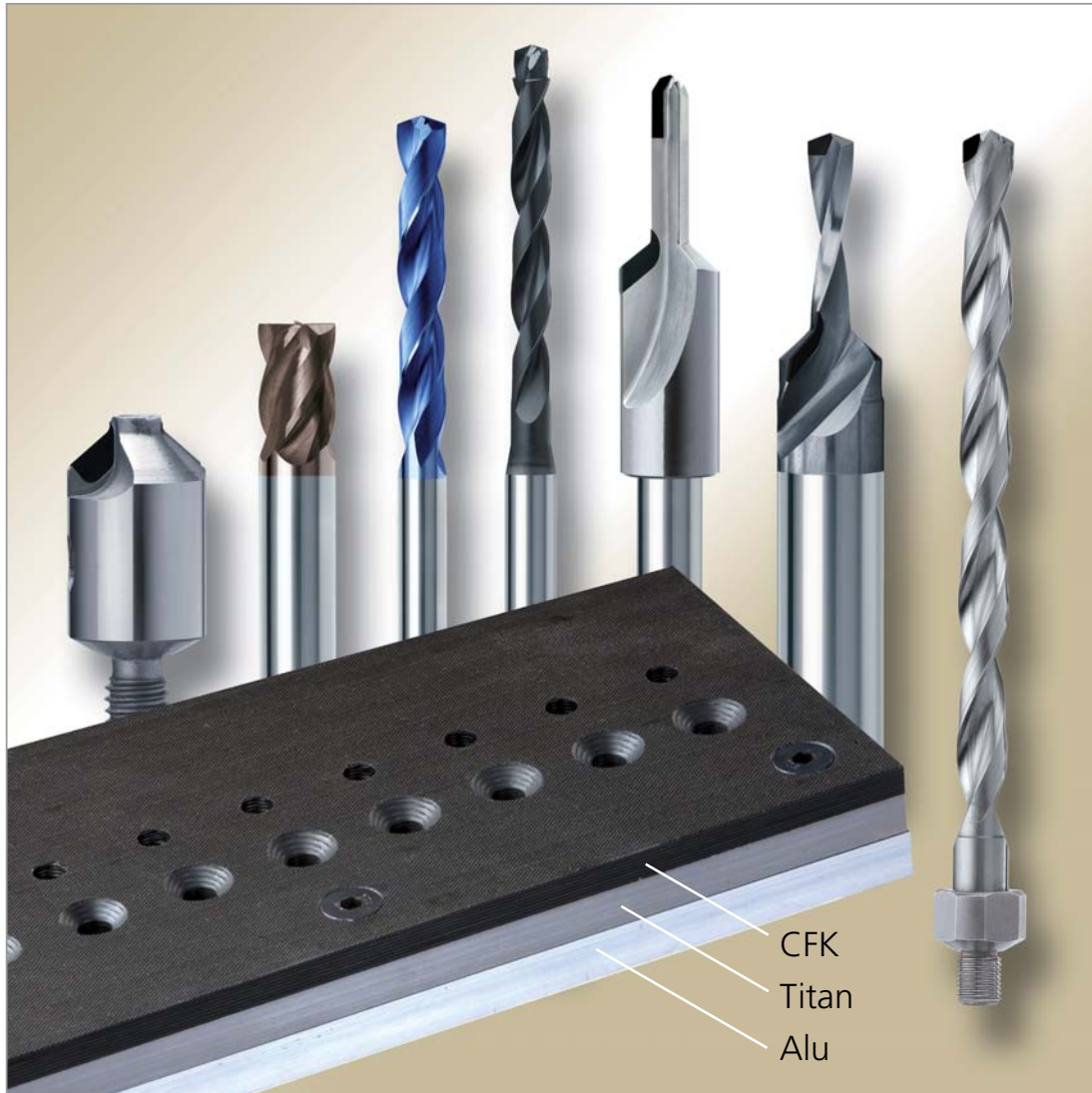

Bearbeitung von Sandwich-Bauteilen.

Machining of stack components.



Tieflochbohrer

deep hole drills

Die neue Generation der extra langen Vollhartmetall-Spiralbohrer bis 40 x D.

The new generation of the extra large solid carbide drills up to 40 x D.

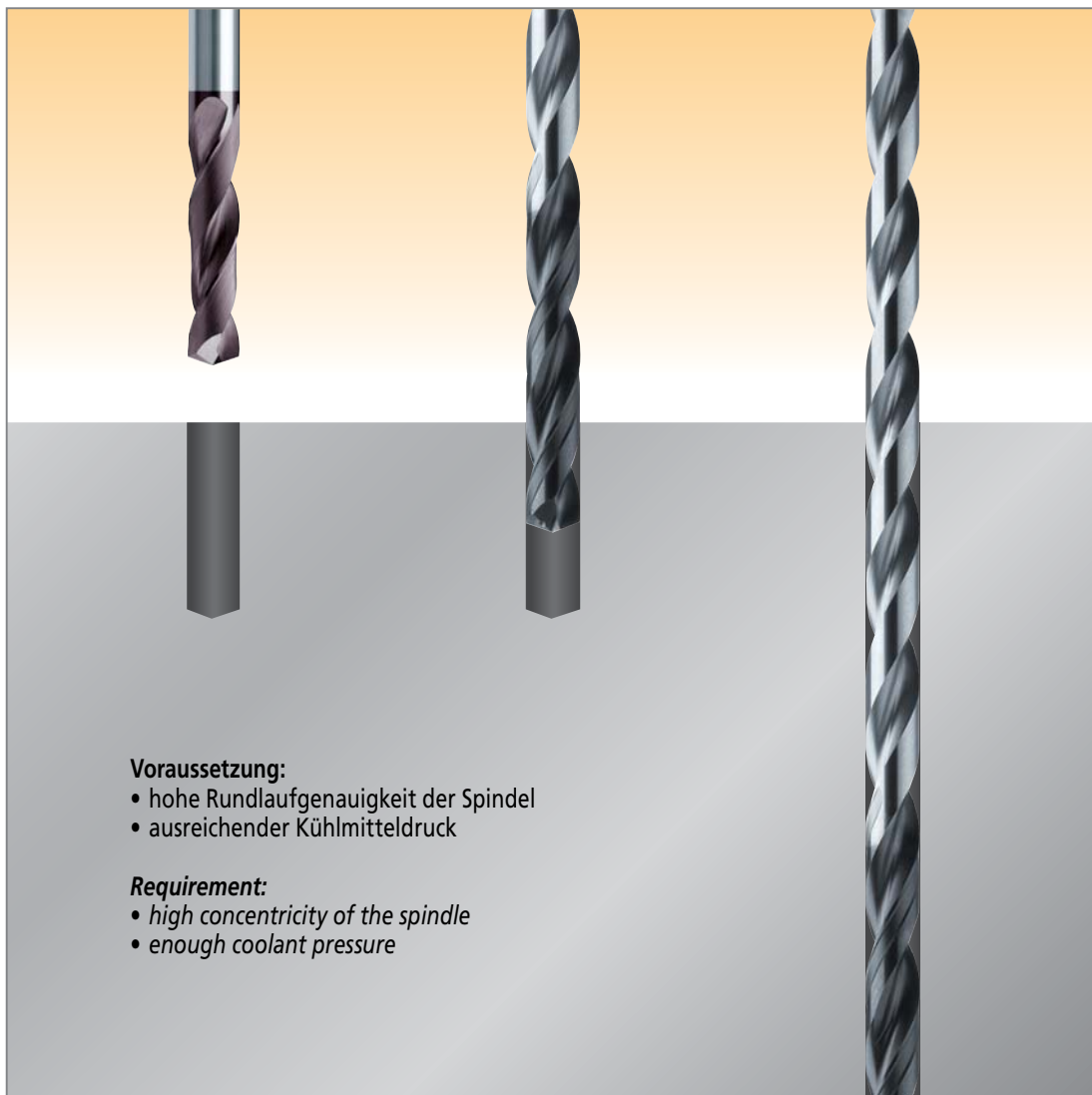

Einsatzempfehlung für Tieflochbohrer mit Bohrtiefe 5 x D bis 40 x D

- Pilotbohrung mit einer Bohrtiefe von 1 x D bis 1,5 x D
- Tieflochbohrer mit geringer Drehzahl in die Pilotbohrung einfahren
- Kühlmittelzufuhr starten
- Bohrvorgang mit empfohlenen Schnittwerten durchführen
- Tieflochbohren ohne entspannen
- nach erreichter Bohrtiefe Tieflochbohrer anheben, Drehzahl reduzieren, Kühlmittelzufuhr unterbrechen und ausfahren

Recommendation for using the deep hole drills 5 x diameter to 40 x diameter

- *drilling a pilot hole 1 x D to 1,5 x D*
- *run with the deep hole drill into the pilot hole with low speed and feed rate*
- *start cooling*
- *increase speed and feed rate*
- *machine the deep hole in one step*
- *lift the drill, reduce speed and feed, stop cooling and extend the drill*

HAM 30-2181

Vollhartmetall-Tieflochbohrer solid carbide deep hole drill 5 x D

VHM	Z 2	30° rechts	Werk Norm
5 x D	Typ Werk	135°	HA
HSF	HPC	SHRINK FIT	

Konstruktions-Daten

- Ø d1 0,8 – 1,45 mm
- Ausführung mit liquid boost
- spezieller 4-Flächenanschliff
- spezielle Schneidkantenverrundung
- spezielle Spankammergeometrie
- Spiralwinkel 30°

Engineering data

- Ø d1 0,8 – 1,45 mm
- liquid boost design
- special 4-facet ground
- special point ground
- special chip flute geometry
- 30° RH helix

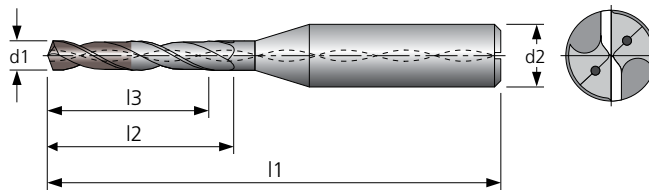

Material	Alu Knet-leg.	Alu Guss-leg.	Stahl < 800 N/mm²	Stahl < 1200 N/mm²	Stahl < 1600 N/mm²	Stahl < 55 HRC	Stahl < 60 HRC	Stahl < 66 HRC	INOX < 800 N/mm²	INOX > 800 N/mm²	GG	GGG	hochw. Legierungen	Titan	NE-Metalle Cu-Leg.	Graphit & Faser-verbund	MMS	max.	ohne	AIR	
30-2181			●	●	○				●	○	●	●	○	○					●		

Schnittdaten siehe Seite / cutting data available on page – 168

● sehr gut geeignet / very suitable ○ bedingt geeignet / limited suitable

Ø d1 (h7) mm	30-2181	l3 mm	l2 mm	l1 mm	Ø d2 (h6) mm	Ø d1 (h7) mm	30-2181	l3 mm	l2 mm	l1 mm	Ø d2 (h6) mm
	TA						TA				
0,8		4	5,5	50	3	1,9		9,5	12,4	55	3
0,85		4,25	5,8	50	3	1,95		9,8	12,7	55	3
0,9		4,5	6	50	3	2		10	13	55	3
0,95		4,75	6,2	50	3	2,05		10,3	13,3	55	3
1		5	6,5	50	3	2,1		10,5	13,7	55	3
1,05		5,3	6,8	50	3	2,15		10,8	14	55	3
1,1		5,5	7,2	50	3	2,2		11	14,3	55	3
1,15		5,8	7,5	50	3	2,25		11,3	14,6	55	3
1,2		6	7,8	50	3	2,3		11,5	15	55	3
1,25		6,3	8,1	50	3	2,35		11,8	15,3	55	3
1,3		6,5	8,5	50	3	2,4		12	15,6	55	3
1,35		6,8	8,8	50	3	2,45		12,3	15,9	55	3
1,4		7	9,1	50	3	2,5		12,5	16,3	55	3
1,45		7,3	9,4	50	3	2,55		12,8	16,6	55	3
1,5		7,5	9,8	50	3	2,6		13	16,9	55	3
1,55		7,8	10,1	50	3	2,65		13,3	17,2	55	3
1,6		8	10,4	55	3	2,7		13,5	17,6	55	3
1,65		8,3	10,7	55	3	2,75		13,8	17,9	55	3
1,7		8,5	11,1	55	3	2,8		14	18,2	55	3
1,75		8,8	11,4	55	3	2,85		14,3	18,5	55	3
1,8		9	11,7	55	3	2,9		14,5	18,9	55	3
1,85		9,3	12	55	3	2,95		14,8	19,2	55	3
						3		15	19,5	55	3

Für Zwischenabmessungen Preis auf Anfrage
For intermediate sizes price on request

Bestellbeispiel / Order example: 30-2181-1,9

Einsatzempfehlung für Tieflochbohrer: Pilotbohrung mit HAM 30-1301
Recommendation for using the deep hole drills: drilling a pilot hole with HAM 30-1301

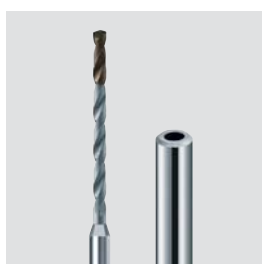

liquid boost

von Nenndurchmesser 0,8 bis 1,45 mm

Vorteile:

- bis zu 3-mal höhere Durchflussmenge bei gleichem Druck
- höhere Standzeiten der Werkzeuge
- effizienteres Entspänen

from nominal diameter 0,8 to 1,45 mm

Advantages:

- with the same pressure up to three times higher flow rate
- higher tool life
- more efficient chip removal

HAM 30-2221

Vollhartmetall-Tieflochbohrer
solid carbide deep hole drill **8 x D**

VHM	Z 2	30° rechts	Werk Norm
8 x D	Typ Werk	135°	HA
HSF	HPC	SHRINK FIT	

Konstruktions-Daten

- Ø d1 0,8 – 1,45 mm
- Ausführung mit liquid boost
- spezieller 4-Flächenanschliff
- spezielle Schneidkantenverrundung
- spezielle Spankammergeometrie
- Spiralwinkel 30°

Engineering data

- Ø d1 0,8 – 1,45 mm
- liquid boost design
- special 4-facet ground
- special point ground
- special chip flute geometry
- 30° RH helix

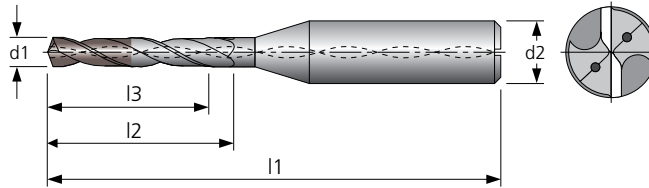

Material	Alu Knet-leg.	Alu Guss-leg.	Stahl < 800 N/mm²	Stahl < 1200 N/mm²	Stahl < 1600 N/mm²	Stahl < 55 HRC	Stahl < 60 HRC	Stahl < 66 HRC	INOX < 800 N/mm²	INOX > 800 N/mm²	GG	GGG	hochw. Legierungen	Titan	NE-Metalle Cu-Leg.	Graphit & Faser-verbund	MMS	max.	ohne	AIR	
30-2221			●	●	○				●	○	●	●	○	○					●		

Schnittdaten siehe Seite / cutting data available on page – 168

● sehr gut geeignet / very suitable ○ bedingt geeignet / limited suitable

Ø d1 (h7) mm	30-2221	l3 mm	l2 mm	l1 mm	Ø d2 (h6) mm	Ø d1 (h7) mm	30-2221	l3 mm	l2 mm	l1 mm	Ø d2 (h6) mm
	TA						TA				
0,8		6,4	8	50	3	1,9		15,2	18,1	60	3
0,85		6,8	8,5	50	3	1,95		15,6	18,5	60	3
0,9		7,2	9	50	3	2		16	19	60	3
0,95		7,6	9,5	50	3	2,05		16,4	19,5	60	3
1		8	9,5	50	3	2,1		16,8	20	60	3
1,05		8,4	10	50	3	2,15		17,2	20,4	60	3
1,1		8,8	10,5	50	3	2,2		17,6	20,9	60	3
1,15		9,2	10,9	50	3	2,25		18	21,4	60	3
1,2		9,6	11,4	50	3	2,3		18,4	21,9	60	3
1,25		10	11,9	50	3	2,35		18,8	22,3	60	3
1,3		10,4	12,4	50	3	2,4		19,2	22,8	60	3
1,35		10,8	12,8	50	3	2,45		19,6	23,3	60	3
1,4		11,2	13,3	50	3	2,5		20	23,8	60	3
1,45		11,6	13,8	50	3	2,55		20,4	24,2	60	3
1,5		12	14,3	50	3	2,6		20,8	24,7	60	3
1,55		12,4	14,7	50	3	2,65		21,2	25,2	60	3
1,6		12,8	15,2	50	3	2,7		21,6	25,7	60	3
1,65		13,2	15,7	60	3	2,75		22	26,1	60	3
1,7		13,6	16,2	60	3	2,8		22,4	26,6	60	3
1,75		14	16,6	60	3	2,85		22,8	27,1	60	3
1,8		14,4	17,1	60	3	2,9		23,2	27,6	60	3
1,85		14,8	17,6	60	3	2,95		23,6	28	60	3
						3		24	28,5	60	3

Für Zwischenabmessungen Preis auf Anfrage
For intermediate sizes price on request

Bestellbeispiel / Order example: 30-2221-1,9

Einsatzempfehlung für Tieflochbohrer: Pilotbohrung mit HAM 30-1301
Recommendation for using the deep hole drills: drilling a pilot hole with HAM 30-1301

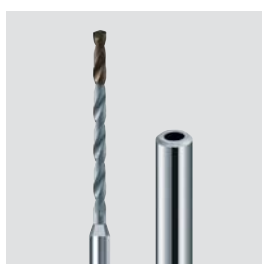

liquid boost

von Nenndurchmesser 0,8 bis 1,45 mm

Vorteile:

- bis zu 3-mal höhere Durchflussmenge bei gleichem Druck
- höhere Standzeiten der Werkzeuge
- effizienteres Entspänen

from nominal diameter 0,8 to 1,45 mm

Advantages:

- with the same pressure up to three times higher flow rate
- higher tool life
- more efficient chip removal

HAM 30-2261

Vollhartmetall-Tieflochbohrer solid carbide deep hole drill 12 x D

VHM	Z 2	30° rechts	Werk Norm
12 x D	Typ Werk	135°	HA
HSF	HPC	SHRINK FIT	

Konstruktions-Daten

- Ø d1 0,8 – 1,45 mm
- Ausführung mit liquid boost
- spezieller 4-Flächenanschliff
- spezielle Schneidkantenverrundung
- spezielle Spankammergeometrie
- Spiralwinkel 30°

Engineering data

- Ø d1 0,8 – 1,45 mm
- liquid boost design
- special 4-facet ground
- special point ground
- special chip flute geometry
- 30° RH helix

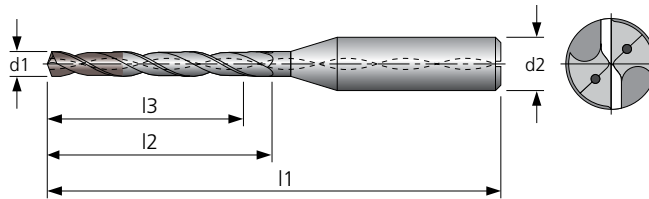

Material	Alu Knet-leg.	Alu Guss-leg.	Stahl < 800 N/mm²	Stahl < 1200 N/mm²	Stahl < 1600 N/mm²	Stahl < 55 HRC	Stahl < 60 HRC	Stahl < 66 HRC	INOX < 800 N/mm²	INOX > 800 N/mm²	GG	GGG	hochw. Legierungen	Titan	NE-Metalle Cu-Leg.	Graphit & Faser-verbund	MMS	max.	ohne	AIR	
30-2261			●	●	○				●	○	●	●	○	○					●	ohne	

Schnittdaten siehe Seite / cutting data available on page – 168

● sehr gut geeignet / very suitable ○ bedingt geeignet / limited suitable

Ø d1 (h7) mm	30-2261					Ø d1 (h7) mm	30-2261				
	TA	l3 mm	l2 mm	l1 mm	Ø d2 (h6) mm		TA	l3 mm	l2 mm	l1 mm	Ø d2 (h6) mm
0,8		9,6	11,2	55	3	1,9		22,8	25,7	65	3
0,85		10,2	11,9	55	3	1,95		23,4	26,3	65	3
0,9		10,8	12,6	55	3	2		24	27	65	3
0,95		11,4	13,3	55	3	2,05		24,6	27,7	65	3
1		12	13,5	55	3	2,1		25,2	28,4	65	3
1,05		12,6	14,2	55	3	2,15		25,8	29	65	3
1,1		13,2	14,9	55	3	2,2		26,4	29,7	65	3
1,15		13,8	15,5	55	3	2,25		27	30,4	65	3
1,2		14,4	16,2	55	3	2,3		27,6	31,1	65	3
1,25		15	16,9	55	3	2,35		28,2	31,7	75	3
1,3		15,6	17,6	55	3	2,4		28,8	32,4	75	3
1,35		16,2	18,2	55	3	2,45		29,4	33,1	75	3
1,4		16,8	18,9	55	3	2,5		30	33,8	75	3
1,45		17,4	19,6	55	3	2,55		30,6	34,4	75	3
1,5		18	20,3	55	3	2,6		31,2	35,1	75	3
1,55		18,6	20,9	55	3	2,65		31,8	35,8	75	3
1,6		19,2	21,6	65	3	2,7		32,4	36,5	75	3
1,65		19,8	22,3	65	3	2,75		33	37,1	75	3
1,7		20,4	23	65	3	2,8		33,6	37,8	75	3
1,75		21	23,6	65	3	2,85		34,2	38,5	75	3
1,8		21,6	24,3	65	3	2,9		34,8	39,2	75	3
1,85		22,2	25	65	3	2,95		35,4	39,8	75	3
						3		36	40,5	75	3

Für Zwischenabmessungen Preis auf Anfrage
For intermediate sizes price on request

Bestellbeispiel / Order example: 30-2261-1,9

Einsatzempfehlung für Tieflochbohrer: Pilotbohrung mit HAM 30-1301
Recommendation for using the deep hole drills: drilling a pilot hole with HAM 30-1301

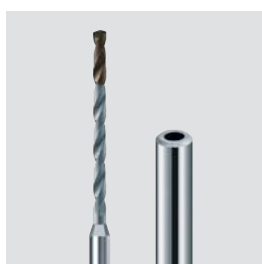

liquid boost

von Nenndurchmesser 0,8 bis 1,45 mm

Vorteile:

- bis zu 3-mal höhere Durchflussmenge bei gleichem Druck
- höhere Standzeiten der Werkzeuge
- effizienteres Entspänen

from nominal diameter 0,8 to 1,45 mm

Advantages:

- with the same pressure up to three times higher flow rate
- higher tool life
- more efficient chip removal

HAM 30-2301

Vollhartmetall-Tieflochbohrer solid carbide deep hole drill 15 x D

VHM	Z 2	30° rechts	Werk Norm
15 x D	Typ Werk	135°	HA
HSF	HPC	SHRINK FIT	

Konstruktions-Daten

- Ø d1 0,8 – 1,45 mm
- Ausführung mit liquid boost
- spezieller 4-Flächenanschliff
- spezielle Schneidkantenverrundung
- spezielle Spankammergeometrie
- Spiralwinkel 30°

Engineering data

- Ø d1 0,8 – 1,45 mm
- liquid boost design
- special 4-facet ground
- special point ground
- special chip flute geometry
- 30° RH helix

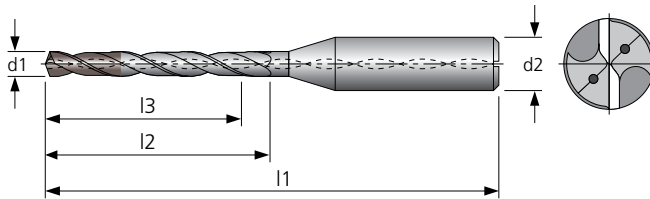

Material	Alu Knet-leg.	Alu Guss-leg.	Stahl < 800 N/mm²	Stahl < 1200 N/mm²	Stahl < 1600 N/mm²	Stahl < 55 HRC	Stahl < 60 HRC	Stahl < 66 HRC	INOX < 800 N/mm²	INOX > 800 N/mm²	GG	GGG	hochw. Legierungen	Titan	NE-Metalle Cu-Leg.	Graphit & Faser-verbund	MMS	max.	ohne	AIR	
30-2301			●	●	○				●	○	●	●	○	○					●		

Schnittdaten siehe Seite / cutting data available on page – 169

● sehr gut geeignet / very suitable ○ bedingt geeignet / limited suitable

Ø d1 (h7) mm	30-2301	l3 mm	l2 mm	l1 mm	Ø d2 (h6) mm	Ø d1 (h7) mm	30-2301	l3 mm	l2 mm	l1 mm	Ø d2 (h6) mm
	TA						TA				
0,8		12	13,6	60	3	1,9		28,5	31,4	75	3
0,85		12,75	14,45	60	3	1,95		29,3	32,2	75	3
0,9		13,5	15,3	60	3	2		30	33	75	3
0,95		14,25	16,15	60	3	2,05		30,8	33,8	75	3
1		15	16,5	60	3	2,1		31,5	34,7	75	3
1,05		15,8	17,3	60	3	2,15		32,3	35,5	75	3
1,1		16,5	18,2	60	3	2,2		33	36,3	75	3
1,15		17,3	19	60	3	2,25		33,8	37,1	75	3
1,2		18	19,8	60	3	2,3		34,5	38	82	3
1,25		18,8	20,6	60	3	2,35		35,3	38,8	82	3
1,3		19,5	21,5	60	3	2,4		36	39,6	82	3
1,35		20,3	22,3	60	3	2,45		36,8	40,4	82	3
1,4		21	23,1	60	3	2,5		37,5	41,3	82	3
1,45		21,8	23,9	60	3	2,55		38,3	42,1	82	3
1,5		22,5	24,8	60	3	2,6		39	42,9	82	3
1,55		23,3	25,6	60	3	2,65		39,8	43,7	82	3
1,6		24	26,4	65	3	2,7		40,5	44,6	82	3
1,65		24,8	27,2	65	3	2,75		41,3	45,4	82	3
1,7		25,5	28,1	65	3	2,8		42	46,2	82	3
1,75		26,3	28,9	65	3	2,85		42,8	47	82	3
1,8		27	29,7	65	3	2,9		43,5	47,9	82	3
1,85		27,8	30,5	75	3	2,95		44,3	48,7	82	3
						3		45	49,5	82	3

Für Zwischenabmessungen Preis auf Anfrage
For intermediate sizes price on request

Bestellbeispiel / Order example: 30-2301-1,9

Einsatzempfehlung für Tieflochbohrer: Pilotbohrung mit HAM 30-1301
Recommendation for using the deep hole drills: drilling a pilot hole with HAM 30-1301

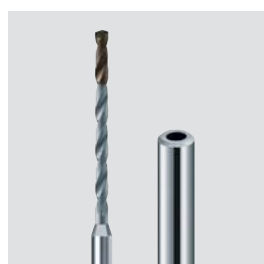

liquid boost

von Nenndurchmesser 0,8 bis 1,45 mm

Vorteile:

- bis zu 3-mal höhere Durchflussmenge bei gleichem Druck
- höhere Standzeiten der Werkzeuge
- effizienteres Entspänen

from nominal diameter 0,8 to 1,45 mm

Advantages:

- with the same pressure up to three times higher flow rate
- higher tool life
- more efficient chip removal

HAM 30-2341

Vollhartmetall-Tieflochbohrer solid carbide deep hole drill 20 x D

VHM	Z 2	30° rechts	Werk Norm
20 x D	Typ Werk	135°	HA
HSF	HPC	SHRINK FIT	

Konstruktions-Daten

- Ø d1 0,8 – 1,45 mm
- Ausführung mit liquid boost
- spezieller 4-Flächenanschliff
- spezielle Schneidkantenverrundung
- spezielle Spankammergeometrie
- Spiralwinkel 30°

Engineering data

- Ø d1 0,8 – 1,45 mm
- liquid boost design
- special 4-facet ground
- special point ground
- special chip flute geometry
- 30° RH helix

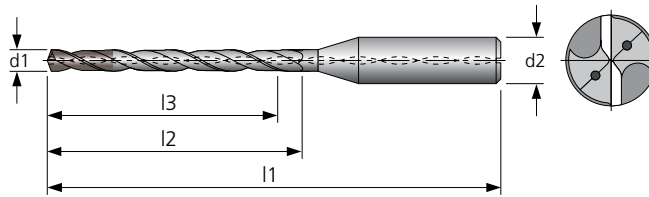

Material	Alu Knet-leg.	Alu Guss-leg.	Stahl < 800 N/mm²	Stahl < 1200 N/mm²	Stahl < 1600 N/mm²	Stahl < 55 HRC	Stahl < 60 HRC	Stahl < 66 HRC	INOX < 800 N/mm²	INOX > 800 N/mm²	GG	GGG	hochw. Legierungen	Titan	NE-Metalle Cu-Leg.	Graphit & Faser-verbund	MMS	max.	ohne	AIR	
30-2341			●	●	○				●	○	●	●	○	○					●		

Schnittdaten siehe Seite / cutting data available on page – 169

● sehr gut geeignet / very suitable ○ bedingt geeignet / limited suitable

Ø d1 (h7) mm	30-2341	l3 mm	l2 mm	l1 mm	Ø d2 (h6) mm	Ø d1 (h7) mm	30-2341	l3 mm	l2 mm	l1 mm	Ø d2 (h6) mm
	TA						TA				
0,8		16	17,6	65	3	1,9		38	40,9	75	3
0,85		17	18,7	65	3	1,95		39	41,9	75	3
0,9		18	19,8	65	3	2		40	43	82	3
0,95		19	20,9	65	3	2,05		41	44,1	82	3
1		20	21,5	65	3	2,1		42	45,2	82	3
1,05		21	22,6	65	3	2,15		43	46,2	82	3
1,1		22	23,7	65	3	2,2		44	47,3	82	3
1,15		23	24,7	65	3	2,25		45	48,4	82	3
1,2		24	25,8	65	3	2,3		46	49,5	100	3
1,25		25	26,9	65	3	2,35		47	50,5	100	3
1,3		26	28	65	3	2,4		48	51,6	100	3
1,35		27	29	65	3	2,45		49	52,7	100	3
1,4		28	30,1	65	3	2,5		50	53,8	100	3
1,45		29	31,2	75	3	2,55		51	54,8	100	3
1,5		30	32,3	75	3	2,6		52	55,9	100	3
1,55		31	33,3	75	3	2,65		53	57	100	3
1,6		32	34,4	75	3	2,7		54	58,1	100	3
1,65		33	35,5	75	3	2,75		55	59,1	100	3
1,7		34	36,6	75	3	2,8		56	60,2	100	3
1,75		35	37,6	75	3	2,85		57	61,3	100	3
1,8		36	38,7	75	3	2,9		58	62,4	100	3
1,85		37	39,8	75	3	2,95		59	63,4	100	3
						3		60	64,5	100	3

Für Zwischenabmessungen Preis auf Anfrage
For intermediate sizes price on request

Bestellbeispiel / Order example: 30-2341-1,9

Einsatzempfehlung für Tieflochbohrer: Pilotbohrung mit HAM 30-1301
Recommendation for using the deep hole drills: drilling a pilot hole with HAM 30-1301

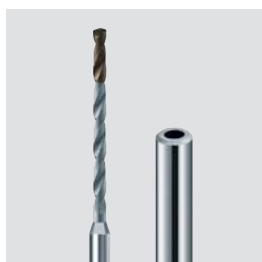

liquid boost

von Nenndurchmesser 0,8 bis 1,45 mm

Vorteile:

- bis zu 3-mal höhere Durchflussmenge bei gleichem Druck
- höhere Standzeiten der Werkzeuge
- effizienteres Entspänen

from nominal diameter 0,8 to 1,45 mm

Advantages:

- with the same pressure up to three times higher flow rate
- higher tool life
- more efficient chip removal

HAM 30-2381

Vollhartmetall-Tieflochbohrer solid carbide deep hole drill 15 x D

VHM	Z 2	30° rechts	Werk Norm
15 x D	Typ Werk	137°	DIN 6535 HAK
HSF		HPC	SHRINK FIT

Konstruktions-Daten

- spezieller 4-Flächenanschliff
- spezielle Schneidkantenverrundung
- spezielle Spankammergeometrie
- 4 Führungsfasen

Engineering data

- special 4-facet ground
- special point ground
- special chip flute geometry
- 4 guide chamfer

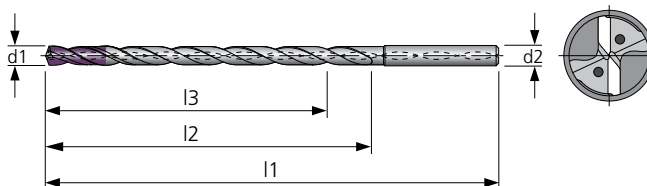

Material	Alu Knet-leg.	Alu Guss-leg.	Stahl < 800 N/mm²	Stahl < 1200 N/mm²	Stahl < 1600 N/mm²	Stahl < 55 HRC	Stahl < 60 HRC	Stahl < 66 HRC	INOX < 800 N/mm²	INOX > 800 N/mm²	GG	GGG	hochw. Legierungen	Titan	NE-Metalle Cu-Leg.	Graphit & Faser-verbund	MMS	max.	ohne	AIR	
30-2381			●	●	○				●	○	●	●	○	○					●		

Schnittdaten siehe Seite / cutting data available on page – 170

● sehr gut geeignet / very suitable ○ bedingt geeignet / limited suitable

Ø d1 (h7) mm	30-2381	l3 mm	l2 mm	l1 mm	Ø d2 (h6) mm
	TA-C				
3		45	51	95	6
4		60	68	110	6
4,5		67,5	76,5	120	6
5		75	85	125	6
5,5		82,5	93,5	135	6
6		90	102	140	6
6,5		97,5	110,5	150	8

Ø d1 (h7) mm	30-2381	l3 mm	l2 mm	l1 mm	Ø d2 (h6) mm
	TA-C				
7		105	119	160	8
8		120	136	175	8
8,5		127,5	144,5	190	10
10		150	170	215	10
12		180	204	255	12
14		210	238	285	14

Für Zwischenabmessungen Preis auf Anfrage
For intermediate sizes price on request

Bestellbeispiel / Order example: 30-2381-7

Einsatzempfehlung für Tieflochbohrer: Pilotbohrung mit HAM 30-1741 oder HAM 30-1621
Recommendation for using the deep hole drills: drilling a pilot hole with HAM 30-1741 or HAM 30-1621

HAM 30-2421

Vollhartmetall-Tieflochbohrer solid carbide deep hole drill 20 x D

VHM	Z 2	30° rechts	Werk Norm
20 x D	Typ Werk	137°	DIN 6535 HAK
HSF		HPC	SHRINK FIT

Konstruktions-Daten

- spezieller 4-Flächenanschliff
- spezielle Schneidkantenverrundung
- spezielle Spankammergeometrie
- 4 Führungsfasen

Engineering data

- special 4-facet ground
- special point ground
- special chip flute geometry
- 4 guide chamfer

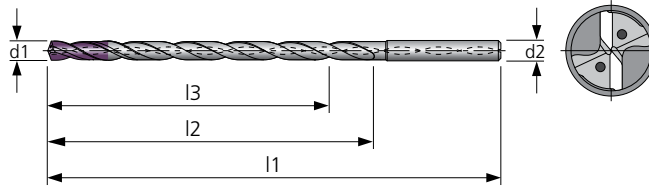

Material	Alu Knet-leg.	Alu Guss-leg.	Stahl < 800 N/mm²	Stahl < 1200 N/mm²	Stahl < 1600 N/mm²	Stahl < 55 HRC	Stahl < 60 HRC	Stahl < 66 HRC	INOX < 800 N/mm²	INOX > 800 N/mm²	GG	GGG	hochw. Legierungen	Titan	NE-Metalle Cu-Leg.	Graphit & Faser-verbund	MMS	max.	ohne	AIR	
30-2421			●	●	○				●	○	●	●	○	○				●			

Schnittdaten siehe Seite / cutting data available on page – 170

● sehr gut geeignet / very suitable ○ bedingt geeignet / limited suitable

Ø d1 (h7) mm	30-2421	l3 mm	l2 mm	l1 mm	Ø d2 (h6) mm
	TA-C				
3		60	66	110	6
4		80	88	130	6
4,5		90	99	140	6
5		100	110	150	6
5,5		110	121	160	6
6		120	132	170	6
6,5		130	143	185	8

Ø d1 (h7) mm	30-2421	l3 mm	l2 mm	l1 mm	Ø d2 (h6) mm
	TA-C				
7		140	154	195	8
8		160	176	215	8
8,5		170	187	230	10
10		200	220	265	10
12		240	264	315	12

Für Zwischenabmessungen Preis auf Anfrage
For intermediate sizes price on request

Bestellbeispiel / Order example: 30-2421-7

Einsatzempfehlung für Tieflochbohrer: Pilotbohrung mit HAM 30-1741 oder HAM 30-1621
Recommendation for using the deep hole drills: drilling a pilot hole with HAM 30-1741 or HAM 30-1621

HAM 30-2461

Vollhartmetall-Tieflochbohrer **25 x D**
solid carbide deep hole drill

VHM	Z 2	30° rechts	Werk Norm
25 x D	Typ Werk	137°	DIN 6535 SHAK
HSF		HPC	SHRINK FIT

- Konstruktions-Daten**
- spezieller 4-Flächenanschliff
 - spezielle Schneidkantenverrundung
 - spezielle Spankammergeometrie
 - 4 Führungsfasen

- Engineering data**
- special 4-facet ground
 - special point ground
 - special chip flute geometry
 - 4 guide chamfer

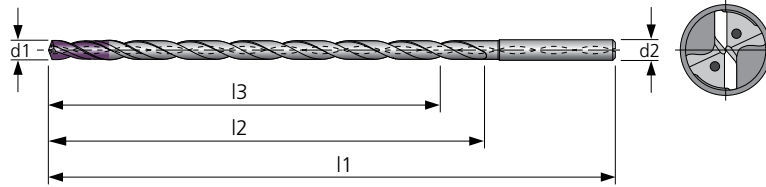

Material	Alu Knet-leg.	Alu Guss-leg.	Stahl < 800 N/mm²	Stahl < 1200 N/mm²	Stahl < 1600 N/mm²	Stahl < 55 HRC	Stahl < 60 HRC	Stahl < 66 HRC	INOX < 800 N/mm²	INOX > 800 N/mm²	GG	GGG	hochw. Legierungen	Titan	NE-Metalle Cu-Leg.	Graphit & Faser-verbund	MMS	max.	ohne	AIR	
30-2461			●	●	○				●	○	●	●	○	○				●			

Schnittdaten siehe Seite / cutting data available on page – 170

● sehr gut geeignet / very suitable ○ bedingt geeignet / limited suitable

Ø d1 (h7) mm	30-2461	l3 mm	l2 mm	l1 mm	Ø d2 (h6) mm
	TA-C				
3		75	81	125	6
4		100	108	150	6
4,5		112,5	121,5	165	6
5		125	135	175	6
5,5		137,5	148,5	190	6

Ø d1 (h7) mm	30-2461	l3 mm	l2 mm	l1 mm	Ø d2 (h6) mm
	TA-C				
6		150	162	200	6
6,5		162,5	175,5	215	8
8		200	216	255	8
10		250	270	315	10

Für Zwischenabmessungen Preis auf Anfrage
 For intermediate sizes price on request

Bestellbeispiel / Order example: 30-2461-6

Einsatzempfehlung für Tieflochbohrer: Pilotbohrung mit HAM 30-1741 oder HAM 30-1621
 Recommendation for using the deep hole drills: drilling a pilot hole with HAM 30-1741 or HAM 30-1621

HAM 30-2501

Vollhartmetall-Tieflochbohrer
solid carbide deep hole drill 30 x D

VHM	Z 2	30° rechts	Werk Norm
30 x D	Typ Werk	137°	DIN 6535 PHAK
HSF		HPC	SHRINK FIT

Konstruktions-Daten

- spezieller 4-Flächenanschliff
- spezielle Schneidkantenverrundung
- spezielle Spankammergeometrie
- 4 Führungsfasen

Engineering data

- special 4-facet ground
- special point ground
- special chip flute geometry
- 4 guide chamfer

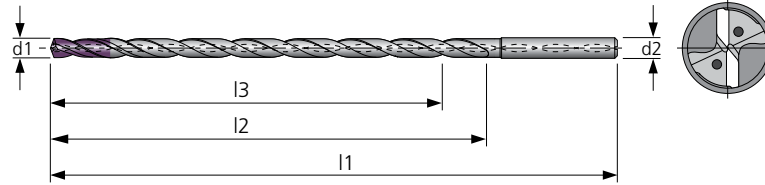

Material	Alu Knet-leg.	Alu Guss-leg.	Stahl < 800 N/mm²	Stahl < 1200 N/mm²	Stahl < 1600 N/mm²	Stahl < 55 HRC	Stahl < 60 HRC	Stahl < 66 HRC	INOX < 800 N/mm²	INOX > 800 N/mm²	GG	GGG	hochw. Legierungen	Titan	NE-Metalle Cu-Leg.	Graphit & Faserverbund	MMS	max.	ohne	AIR	
30-2501			●	●	○				●	○	●	●	○	○				●			

Schnittdaten siehe Seite / cutting data available on page – 170

● sehr gut geeignet / very suitable ○ bedingt geeignet / limited suitable

Ø d1 (h7) mm	30-2501	l3 mm	l2 mm	l1 mm	Ø d2 (h6) mm
	TA-C				
3		90	96	140	6
4		120	128	170	6
4,5		135	144	185	6
5		150	160	200	6
5,5		165	176	215	6

Ø d1 (h7) mm	30-2501	l3 mm	l2 mm	l1 mm	Ø d2 (h6) mm
	TA-C				
6		180	192	230	6
6,5		195	208	250	8
7		210	224	265	8
8		240	256	295	8

Für Zwischenabmessungen Preis auf Anfrage
For intermediate sizes price on request

Bestellbeispiel / Order example: 30-2501-6

Einsatzempfehlung für Tieflochbohrer: Pilotbohrung mit HAM 30-1741 oder HAM 30-1621
Recommendation for using the deep hole drills: drilling a pilot hole with HAM 30-1741 or HAM 30-1621

HAM 30-2541

Vollhartmetall-Tieflochbohrer
solid carbide deep hole drill **40 x D**

VHM	Z 2	30° rechts	Werk Norm
40 x D	Typ Werk	137°	DIN 6535 SHAK
HSF		HPC	SHRINK FIT

Konstruktions-Daten

- spezieller 4-Flächenanschliff
- spezielle Schneidkantenverrundung
- spezielle Spankammergeometrie
- 4 Führungsfasen

Engineering data

- special 4-facet ground
- special point ground
- special chip flute geometry
- 4 guide chamfer

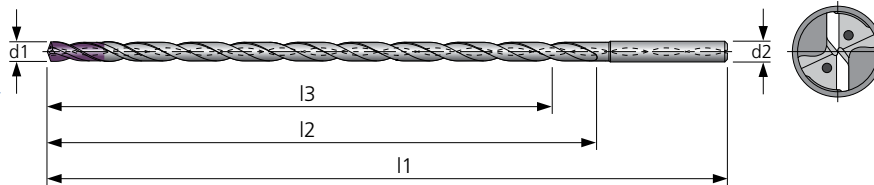

Material	Alu Knet-leg.	Alu Guss-leg.	Stahl < 800 N/mm²	Stahl < 1200 N/mm²	Stahl < 1600 N/mm²	Stahl < 55 HRC	Stahl < 60 HRC	Stahl < 66 HRC	INOX < 800 N/mm²	INOX > 800 N/mm²	GG	GGG	hochw. Legierungen	Titan	NE-Metalle Cu-Leg.	Graphit & Faserverbund	MMS	max.	ohne	AIR
30-2541			●	●	○				●	○	●	●	○	○				●		

Schnittdaten siehe Seite / cutting data available on page – 170

● sehr gut geeignet / very suitable ○ bedingt geeignet / limited suitable

Ø d1 (h7) mm	30-2541	l3	l2	l1	Ø d2 (h6) mm
	TA-C	mm	mm	mm	mm
4		160	168	210	6

Ø d1 (h7) mm	30-2541	l3	l2	l1	Ø d2 (h6) mm
	TA-C	mm	mm	mm	mm
5		200	210	250	6

Für Zwischenabmessungen Preis auf Anfrage
For intermediate sizes price on request

Bestellbeispiel / Order example: 30-2541-5

Einsatzempfehlung für Tieflochbohrer: Pilotbohrung mit HAM 30-1741 oder HAM 30-1621
Recommendation for using the deep hole drills: drilling a pilot hole with HAM 30-1741 or HAM 30-1621

HAM 30-2580

Vollhartmetall-Tieflochbohrer solid carbide deep hole drill 15 x D

VHM	Z 2	15° rechts	Werk Norm
15 x D	Typ Werk	137°	DIN 6535 HAK
HSF	HPC	SHRINK FIT	

Konstruktions-Daten

- spezieller 4-Flächenanschliff
- spezielle Schneidkantenverrundung
- spezielle Spankammergeometrie
- Spiralwinkel 15°
- 4 Führungsfasen

Engineering data

- special 4-facet ground
- special point ground
- special chip flute geometry
- 15° RH helix
- 4 guide chamfer

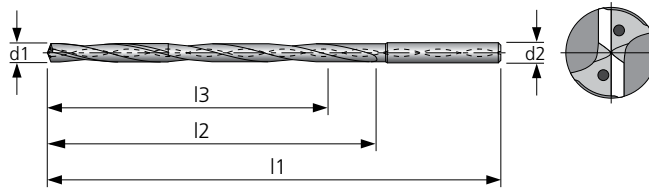

Material	Alu Knet-leg.	Alu Guss-leg.	Stahl < 800 N/mm²	Stahl < 1200 N/mm²	Stahl < 1600 N/mm²	Stahl < 55 HRC	Stahl < 60 HRC	Stahl < 66 HRC	INOX < 800 N/mm²	INOX > 800 N/mm²	GG	GGG	hochw. Legierungen	Titan	NE-Metalle Cu-Leg.	Graphit & Faserverbund	MMS	max.	ohne	AIR
30-2580	●	●													●			●		

Schnittdaten siehe Seite / cutting data available on page - 171

● sehr gut geeignet / very suitable ○ bedingt geeignet / limited suitable

Ø d1 (h7) mm	30-2580	l3 mm	l2 mm	l1 mm	Ø d2 (h6) mm
3		45	51	95	6
3,2		48	54,4	100	6
3,3		49,5	56,1	100	6
3,5		52,5	59,5	110	6
3,8		57	64,6	110	6
4		60	68	110	6
4,2		63	71,4	120	6
4,5		67,5	76,5	120	6
4,8		72	81,6	125	6
5		75	85	125	6
5,5		82,5	93,5	135	6
5,8		87	98,6	140	6
6		90	100	140	6
6,5		97,5	110,5	150	8
6,8		102	115,6	160	8

Ø d1 (h7) mm	30-2580	l3 mm	l2 mm	l1 mm	Ø d2 (h6) mm
7		105	119	160	8
7,5		112,5	127,5	165	8
7,8		117	132,6	170	8
8		120	136	180	8
8,5		127,5	144,5	190	10
8,8		132	149,6	200	10
9		135	153	200	10
9,8		147	166,6	215	10
10		150	170	215	10
10,2		153	173,4	230	12
10,8		162	183,6	235	12
11,8		177	200,6	255	12
12		180	204	255	12
14		210	238	285	14

Für Zwischenabmessungen Preis auf Anfrage
For intermediate sizes price on request

Bestellbeispiel / Order example: 30-2580-7

Einsatzempfehlung für Tieflochbohrer: Pilotbohrung mit HAM 30-1881 oder HAM 30-1891
Recommendation for using the deep hole drills: drilling a pilot hole with HAM 30-1881 or HAM 30-1891

HAM 30-2620

Vollhartmetall-Tieflochbohrer solid carbide deep hole drill 20 x D

VHM	Z 2	15° rechts	Werk Norm
20 x D	Typ Werk	137°	DIN 6535 HAK
HSF	HPC	SHRINK FIT	

Konstruktions-Daten

- spezieller 4-Flächenanschliff
- spezielle Schneidkantenverrundung
- spezielle Spankammergeometrie
- Spiralwinkel 15°
- 4 Führungsfasen

Engineering data

- special 4-facet ground
- special point ground
- special chip flute geometry
- 15° RH helix
- 4 guide chamfer

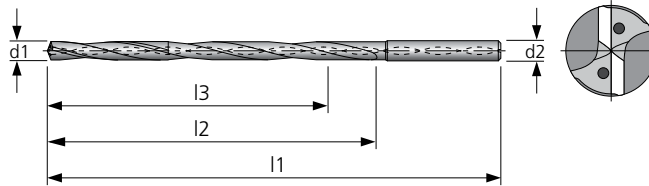

Material	Alu Knet-leg.	Alu Guss-leg.	Stahl < 800 N/mm²	Stahl < 1200 N/mm²	Stahl < 1600 N/mm²	Stahl < 55 HRC	Stahl < 60 HRC	Stahl < 66 HRC	INOX < 800 N/mm²	INOX > 800 N/mm²	GG	GGG	hochw. Legierungen	Titan	NE-Metalle Cu-Leg.	Graphit & Faser-verbund	MMS	max.	ohne	AIR
30-2620	●	●													●			●		

Schnittdaten siehe Seite / cutting data available on page – 171

● sehr gut geeignet / very suitable ○ bedingt geeignet / limited suitable

Ø d1 (h7) mm	30-2620					Ø d1 (h7) mm	30-2620				
	l3 mm	l2 mm	l1 mm	Ø d2 (h6) mm	l3 mm		l2 mm	l1 mm	Ø d2 (h6) mm		
2	40	44	80	4	6,5	130	143	185	8		
2,2	44	48,4	85	4	6,8	136	149,6	195	8		
2,3	46	50,6	85	4	7	140	154	195	8		
2,4	48	52,8	90	4	7,5	150	165	210	8		
2,5	50	55	90	4	7,8	156	171,6	215	8		
2,7	54	59,4	95	4	8	160	176	215	8		
2,8	56	61,6	95	4	8,5	170	187	230	10		
3	60	66	110	6	8,8	176	193,6	240	10		
3,2	64	70,4	115	6	9	180	198	250	10		
3,3	66	72,6	115	6	9,8	196	215,6	265	10		
3,5	70	77	120	6	10	200	220	265	10		
3,8	76	83,6	130	6	10,2	204	224,4	275	12		
4	80	88	130	6	10,8	216	237,6	295	12		
4,2	84	92,4	140	6	11,8	236	259,6	315	12		
4,5	90	99	140	6	12	240	264	315	12		
4,8	96	105,6	150	6							
5	100	110	150	6							
5,5	110	121	160	6							
5,8	116	127,6	170	6							
6	120	132	170	6							

Für Zwischenabmessungen Preis auf Anfrage
For intermediate sizes price on request

Bestellbeispiel / Order example: 30-2620-6,5

Einsatzempfehlung für Tieflochbohrer: Pilotbohrung mit HAM 30-1881 oder HAM 30-1891
Recommendation for using the deep hole drills: drilling a pilot hole with HAM 30-1881 or HAM 30-1891

HAM 30-2660

Vollhartmetall-Tieflochbohrer
solid carbide deep hole drill 25 x D

VHM	Z 2	15° rechts	Werk Norm
25 x D	Typ Werk	137°	DIN 6535 HAK
HSF		HPC	SHRINK FIT

- Konstruktions-Daten**
- spezieller 4-Flächenanschliff
 - spezielle Schneidkantenverrundung
 - spezielle Spankammergeometrie
 - Spiralwinkel 15°
 - 4 Führungsfasen

- Engineering data**
- special 4-facet ground
 - special point ground
 - special chip flute geometry
 - 15° RH helix
 - 4 guide chamfer

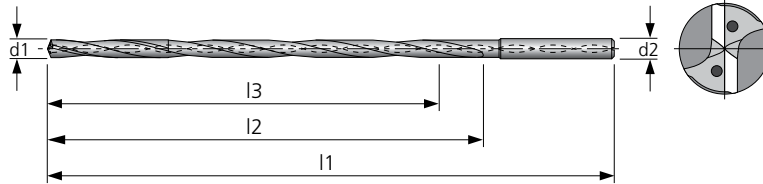

Material	Alu Knet-leg.	Alu Guss-leg.	Stahl < 800 N/mm²	Stahl < 1200 N/mm²	Stahl < 1600 N/mm²	Stahl < 55 HRC	Stahl < 60 HRC	Stahl < 66 HRC	INOX < 800 N/mm²	INOX > 800 N/mm²	GG	GGG	hochw. Legierungen	Titan	NE-Metalle Cu-Leg.	Graphit & Faser-verbund	MMS	max.	ohne	AIR
30-2660	●	●													●			●		

Schnittdaten siehe Seite / cutting data available on page – 171

● sehr gut geeignet / very suitable ○ bedingt geeignet / limited suitable

Ø d1 (h7) mm	30-2660	l3 mm	l2 mm	l1 mm	Ø d2 (h6) mm	Ø d1 (h7) mm	30-2660	l3 mm	l2 mm	l1 mm	Ø d2 (h6) mm
3		75	81	125	6	7		175	189	230	8
3,2		80	86,4	130	6	7,5		187,5	202,5	255	8
3,3		82,5	89,1	140	6	7,8		195	210,6	255	8
3,5		87,5	94,5	140	6	8		200	216	255	8
3,8		95	102,6	150	6	8,5		212,5	229,5	285	10
4		100	108	150	6	8,8		220	237,6	310	10
4,2		105	113,4	160	6	9		225	243	310	10
4,5		112,5	121,5	165	6	9,8		245	264,6	310	10
4,8		120	129,6	175	6	10		250	270	315	10
5		125	135	175	6	10,2		255	275,4	325	12
5,5		137,5	148,5	190	6	10,8		270	291,6	340	12
5,8		145	156,6	200	6	11,8		295	318,6	375	12
6		150	162	200	6	12		300	324	375	12
6,5		162,5	175,5	215	8						
6,8		170	183,6	230	8						

Für Zwischenabmessungen Preis auf Anfrage
For intermediate sizes price on request

Bestellbeispiel / Order example: 30-2660-7

Einsatzempfehlung für Tieflochbohrer: Pilotbohrung mit HAM 30-1881 oder HAM 30-1891
Recommendation for using the deep hole drills: drilling a pilot hole with HAM 30-1881 or HAM 30-1891

HAM 30-2700

Vollhartmetall-Tieflochbohrer **30 x D**
solid carbide deep hole drill

VHM	Z 2	15° rechts	Werk Norm
30 x D	Typ Werk	137°	DIN 6535 HAK
HSF		HPC	SHRINK FIT

Konstruktions-Daten

- spezieller 4-Flächenanschliff
- spezielle Schneidkantenverrundung
- spezielle Spankammergeometrie
- Spiralwinkel 15°
- 4 Führungsfasen

Engineering data

- special 4-facet ground
- special point ground
- special chip flute geometry
- 15° RH helix
- 4 guide chamfer

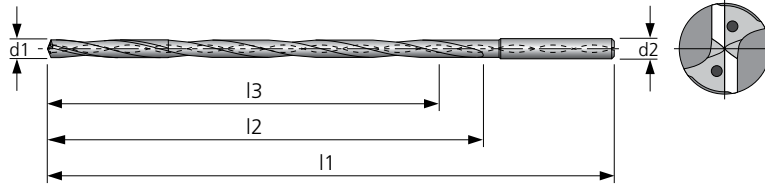

Material	Alu Knet-leg.	Alu Guss-leg.	Stahl < 800 N/mm²	Stahl < 1200 N/mm²	Stahl < 1600 N/mm²	Stahl < 55 HRC	Stahl < 60 HRC	Stahl < 66 HRC	INOX < 800 N/mm²	INOX > 800 N/mm²	GG	GGG	hochw. Legierungen	Titan	NE-Metalle Cu-Leg.	Graphit & Faser-verbund	MMS	max.	ohne	AIR
30-2700	●	●													●			●		

Schnittdaten siehe Seite / cutting data available on page – 171

● sehr gut geeignet / very suitable ○ bedingt geeignet / limited suitable

Ø d1 (h7) mm	30-2700					Ø d1 (h7) mm	30-2700				
	l3 mm	l2 mm	l1 mm	Ø d2 (h6) mm	l3 mm		l2 mm	l1 mm	Ø d2 (h6) mm		
2	60	64	110	4	6,5	195	208	250	8		
2,2	66	70,4	110	4	6,8	204	217,6	265	8		
2,3	69	73,6	110	4	7	210	224	265	8		
2,4	72	76,8	110	4	7,5	225	240	280	8		
2,5	75	80	115	4	7,8	234	249,6	315	8		
2,7	81	86,4	120	4	8	240	256	315	8		
2,8	84	89,6	125	4	8,5	255	272	315	10		
3	90	96	140	6	8,8	264	281,6	325	10		
3,2	96	102,4	150	6	9	270	288	335	10		
3,3	99	105,6	150	6	9,8	294	313,6	360	10		
3,5	105	112	155	6	10	300	320	365	10		
3,8	114	121,6	170	6	10,2	306	326,4	375	12		
4	120	128	170	6	10,8	324	345,6	395	12		
4,2	126	134,4	185	6	11,8	354	377,6	425	12		
4,5	135	144	185	6	12	360	384	430	12		
4,8	144	153,6	200	6							
5	150	160	200	6							
5,5	165	176	215	6							
5,8	174	185,6	230	6							
6	180	192	230	6							

Für Zwischenabmessungen Preis auf Anfrage
For intermediate sizes price on request

Bestellbeispiel / Order example: 30-2700-6,5

Einsatzempfehlung für Tieflochbohrer: Pilotbohrung mit HAM 30-1881 oder HAM 30-1891
Recommendation for using the deep hole drills: drilling a pilot hole with HAM 30-1881 or HAM 30-1891

HAM 30-2740

Vollhartmetall-Tieflochbohrer
solid carbide deep hole drill 40 x D

VHM	Z 2	15° rechts	Werk Norm
40 x D	Typ Werk	137°	DIN 6535 PHAK
HSF		HPC	SHRINK FIT

Konstruktions-Daten

- spezieller 4-Flächenanschliff
- spezielle Schneidkantenverrundung
- spezielle Spankammergeometrie
- Spiralwinkel 15°
- 4 Führungsfasen

Engineering data

- special 4-facet ground
- special point ground
- special chip flute geometry
- 15° RH helix
- 4 guide chamfer

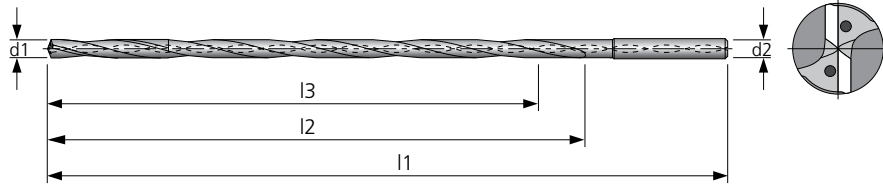

Material	Alu Knet-leg.	Alu Guss-leg.	Stahl < 800 N/mm²	Stahl < 1200 N/mm²	Stahl < 1600 N/mm²	Stahl < 55 HRC	Stahl < 60 HRC	Stahl < 66 HRC	INOX < 800 N/mm²	INOX > 800 N/mm²	GG	GGG	hochw. Legierungen	Titan	NE-Metalle Cu-Leg.	Graphit & Faser-verbund	MMS	max.	ohne	AIR
30-2740	●	●													●			●		

Schnittdaten siehe Seite / cutting data available on page – 171

● sehr gut geeignet / very suitable ○ bedingt geeignet / limited suitable

Ø d1 (h7) mm	30-2740	l3 mm	l2 mm	l1 mm	Ø d2 (h6) mm
4		160	168	210	6

Ø d1 (h7) mm	30-2740	l3 mm	l2 mm	l1 mm	Ø d2 (h6) mm
5		200	210	250	6

Für Zwischenabmessungen Preis auf Anfrage
For intermediate sizes price on request

Bestellbeispiel / Order example: 30-2740-5

Einsatzempfehlung für Tieflochbohrer: Pilotbohrung mit HAM 30-1881 oder HAM 30-1891
Recommendation for using the deep hole drills: drilling a pilot hole with HAM 30-1881 or HAM 30-1891

Präzisionswerkzeuge

precision tools



HAM – Ihr kompetenter Partner in der Präzisionswerkzeug-Technologie

HAM – Your competent partner in the precision tool technology

Spezialbohrer special drills



Spezialbohrer zum Zentrieren, Anbohren
und Senken für höchste Ansprüche.

*Special drills – centering and countersinking
for highest requirements.*

HAM 30-2800

Vollhartmetall-Zentrierbohrer solid carbide center drill

VHM
Z 2
rechts
DIN 333 A
Typ N
120°
HA

Konstruktions-Daten

- 4-Flächenanschliff
- spiralgenutet
- Ø d1 0,5 – 0,8 mm
nur einseitig geschliffen

Engineering data

- 4-facet ground
- spiral fluted
- Ø d1 0,5 – 0,8 mm
only ground on one side

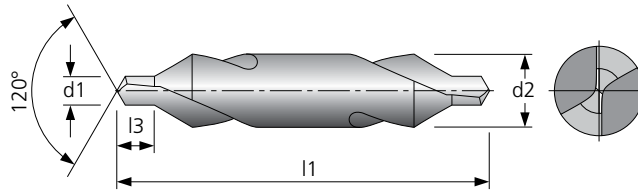

Material	Alu Knet-leg.	Alu Guss-leg.	Stahl < 800 N/mm²	Stahl < 1200 N/mm²	Stahl < 1600 N/mm²	Stahl < 55 HRC	Stahl < 60 HRC	Stahl < 66 HRC	INOX < 800 N/mm²	INOX > 800 N/mm²	GG	GGG	hochw. Legierungen	Titan	NE-Metalle Cu-Leg.	Graphit & Faser-verbund	MMS	max.	ohne	AIR
30-2800	●	●	●	●	●				○	○	●	●	○	○	●		●	●	○	○

Schnittdaten siehe Seite / cutting data available on page – 172

● sehr gut geeignet / very suitable ○ bedingt geeignet / limited suitable

Ø d1 DIN mm	30-2800	l3 mm	l1 mm	Ø d2 (h6) mm	Ø d1 DIN mm	30-2800	l3 mm	l1 mm	Ø d2 (h6) mm
0,5		0,8	25	3,15	2		2,5	40	5
0,8		1,1	25	3,15	2,5		3,1	45	6,3
1		1,3	31,5	3,15	3,15		3,9	50	8
1,25		1,6	31,5	3,15	4		5	56	10
1,6		2	35,5	4	5		6,3	63	12,5
					6,3		8	71	16

Bestellbeispiel / Order example: 30-2800-2

HAM 30-2840

Vollhartmetall-NC-Anbohrer solid carbide NC-center drill

VHM Z 2 30° rechts Werk Norm
Typ N 120° HA
SHRINK FIT

- Konstruktions-Daten**
- spezieller Kegelmantelschliff
 - schmale Querschneide
 - kurze Spannutt

- Engineering data**
- point ground: relieved cone
 - spotting drill geometry
 - short flute length

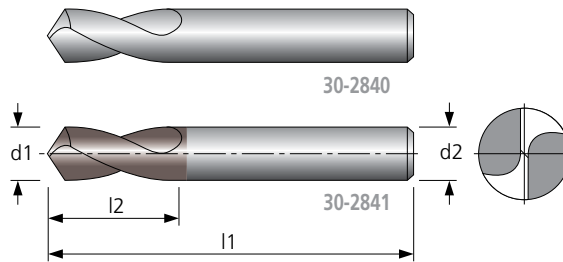

Material	Alu Knet-leg.	Alu Guss-leg.	Stahl < 800 N/mm²	Stahl < 1200 N/mm²	Stahl < 1600 N/mm²	Stahl < 55 HRC	Stahl < 60 HRC	Stahl < 66 HRC	INOX < 800 N/mm²	INOX > 800 N/mm²	GG	GGG	hochw. Legierungen	Titan	NE-Metalle Cu-Leg.	Graphit & Faser-verbund	MMS	max.	ohne	AIR
30-2840	●	●	○	○							○				●	○	●	●	○	○
30-2841	○	○	●	●	○				○	○	●	●	○	○	○	○	●	●	○	○

Schnittdaten siehe Seite / cutting data available on page - 173

● sehr gut geeignet / very suitable ○ bedingt geeignet / limited suitable

Ø d1 (h6) mm	30-2840	30-2841	l2 mm	l1 mm	Ø d2 (h6) mm
		TA			
5			10	62	5
6			15	66	6
8			20	79	8
10			22	89	10
12			25	102	12

Ø d1 (h6) mm	30-2840	30-2841	l2 mm	l1 mm	Ø d2 (h6) mm
		TA			
16			35	115	16
20			40	131	20

Bestellbeispiel / Order example: 30-2840-16

HAM 30-2880

Vollhartmetall-NC-Anbohrer solid carbide NC-center drill

VHM
Z 2
20° rechts
Werk Norm

Typ N
90°
HA

SHRINK FIT

- Konstruktions-Daten**
- spezieller Kegelmantelschliff
 - schmale Querschneide
 - kurze Spannüt

- Engineering data**
- point ground: relieved cone
 - spotting drill geometry
 - short flute length

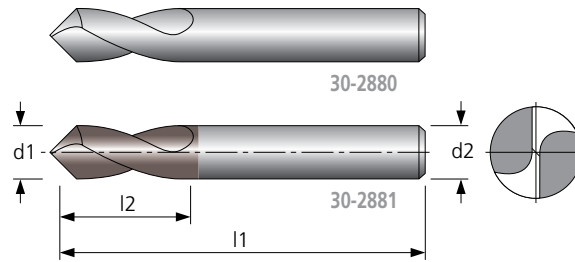

Material	Alu Knet-leg.	Alu Guss-leg.	Stahl < 800 N/mm²	Stahl < 1200 N/mm²	Stahl < 1600 N/mm²	Stahl < 55 HRC	Stahl < 60 HRC	Stahl < 66 HRC	INOX < 800 N/mm²	INOX > 800 N/mm²	GG	GGG	hochw. Legierungen	Titan	NE-Metalle Cu-Leg.	Graphit & Faser-verbund	MMS	max.	ohne	AIR
30-2880	●	●	○	○							○	○	○	○	○	○	●	●	○	○
30-2881	○	○	●	●	○				○	○	●	●	○	○	○	○	●	●	○	○

Schnittdaten siehe Seite / cutting data available on page - 174

● sehr gut geeignet / very suitable ○ bedingt geeignet / limited suitable

Ø d1 (h6) mm	30-2880	30-2881	l2 mm	l1 mm	Ø d2 (h6) mm
		TA			
5			10	62	5
6			15	66	6
8			20	79	8
10			22	89	10
12			25	102	12

Ø d1 (h6) mm	30-2880	30-2881	l2 mm	l1 mm	Ø d2 (h6) mm
		TA			
16			35	115	16
20			40	131	20

Bestellbeispiel / Order example: 30-2880-16

HAM 30-2920

Vollhartmetall-Dreischneidensenker solid carbide three fluted countersinker

VHM	Z 3	0° Nut	DIN 335 C
Typ Werk	90°	HA	

- Konstruktions-Daten**
- 3 Schneiden
 - für Senkungen nach DIN 74
 - spezieller Kegelmantelschliff

- Engineering data**
- 3 cutting edges
 - for counterbores acc. DIN 74
 - point ground: relieved cone

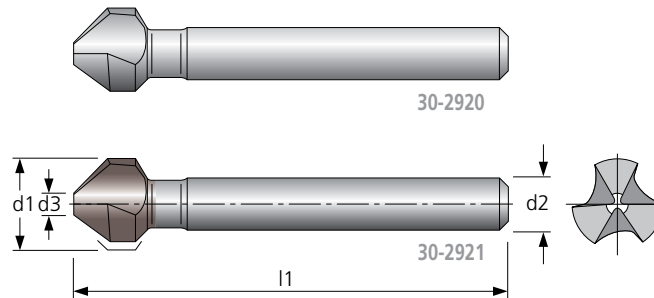

Material	Alu Knet-leg.	Alu Gus-leg.	Stahl < 800 N/mm²	Stahl < 1200 N/mm²	Stahl < 1600 N/mm²	Stahl < 55 HRC	Stahl < 60 HRC	Stahl < 66 HRC	INOX < 800 N/mm²	INOX > 800 N/mm²	GG	GGG	hochw. Legierungen	Titan	NE-Metalle Cu-Leg.	Graphit & Faser-verbund	MMS	max.	ohne	AIR
30-2920	●	●	○	○	●	●	○	○	○	○	○	○	○	○	○	○	○	○	○	○
30-2921	○	○	●	●	●	●	○	○	○	○	●	●	○	○	○	○	○	○	○	○

Schnittdaten siehe Seite / cutting data available on page – 175

● sehr gut geeignet / very suitable ○ bedingt geeignet / limited suitable

Ø d1 (z9) mm	30-2920	30-2921	Ø d3 mm	l1 mm	Ø d2 (h7) mm
		TA			
6,3			1,5	45	5
8,3			2	50	6
10,4			2,5	50	6
12,4			2,8	56	8
15			3,2	60	10

Ø d1 (z9) mm	30-2920	30-2921	Ø d3 mm	l1 mm	Ø d2 (h7) mm
		TA			
16,5			3,2	60	10
20,5			3,5	63	10
25			3,8	67	10
31			4,2	71	12

Bestellbeispiel / Order example: 30-2920-16,5

Reib- und Feinstbearbeitungswerkzeuge *reaming and fine-boring tools*



HAM Reib- und Feinstbearbeitungswerkzeuge aus Vollhartmetall, Cermet, Diamant und CBN.

HAM Reaming and fine-boring tools made from solid carbide, cermet, diamond and CBN.

Reibahlen

reamers



Hochpräzise Reibwerkzeuge
aus Vollhartmetall.

*Highly precise reamers
in solid carbide.*

HAM 50-1040

Vollhartmetall-Maschinenreibahlen solid carbide chucking reamers

VHM	Z 4-6	6°-8° li	Werk Norm
Typ Werk	H 7	HA	

Konstruktions-Daten

- ungleiche Teilung
- kurzer Anschnitt
- Herstellungstoleranz nach DIN 1420

Engineering data

- unequal division
- short bevel
- design as specified acc. DIN 1420

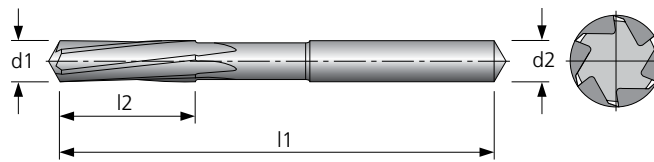

Material	Alu Knet- leg.	Alu Guss- leg.	Stahl < 800 N/mm ²	Stahl < 1200 N/mm ²	Stahl < 1600 N/mm ²	Stahl < 55 HRC	Stahl < 60 HRC	Stahl < 66 HRC	INOX < 800 N/mm ²	INOX > 800 N/mm ²	GG	GGG	hochw. Legie- rungen	Titan	NE- Metalle Cu-Leg.	Graphit & Faser- verbund	MMS	max.	ohne	AIR
50-1040	●	●	●	●	●	●			○	○	●	●	○	●	●		○	●	○	

Schnittdaten siehe Seite / cutting data available on page - 177

● sehr gut geeignet / very suitable ○ bedingt geeignet / limited suitable

Ø d1 (H7) mm	50-1040	Ø d1 von ... bis	l2 mm	l1 mm	Z	Ø d2 (h6) mm
2		1,90 – 2,12	11	49	4	2
2,2		2,13 – 2,36	12	53	4	2,2
2,5		2,37 – 2,65	14	57	4	2,5
3		2,66 – 3,15	20	61	6	3
3,5		3,16 – 3,75	22	70	6	3,5
4		3,76 – 4,25	22	75	6	4
4,5		4,26 – 4,75	22	75	6	4,5
5		4,76 – 5,30	28	86	6	5
5,5		5,31 – 5,80	28	93	6	5,6
6		5,81 – 6,20	30	93	6	5,6

Ø d1 (H7) mm	50-1040	Ø d1 von ... bis	l2 mm	l1 mm	Z	Ø d2 (h6) mm
6,5		6,21 – 6,70	30	101	6	6,3
7		6,71 – 7,50	30	109	6	7,1
8		7,51 – 8,50	32	117	6	8
9		8,51 – 9,50	36	125	6	9
10		9,51 – 10,50	38	133	6	10
11		10,51 – 11,50	41	142	6	10
12		11,51 – 12,00	44	151	6	10

Zuschläge für Zwischenabmessungen und andere Passungen als H7
finden Sie auf Seite 237.
Extra charges for intermediate sizes and other fits than H7
can be found on page 237.

Bestellbeispiel / Order example: 50-1040-6,5

HAM 50-1080

Vollhartmetall-Automaten-Reibahlen solid carbide chucking reamers

VHM	Z 6-8	6°-8°re	Werk Norm
Typ Werk	H 7	HA	

Konstruktions-Daten

- ungleiche Teilung
- kurzer Anschnitt
- Herstellungstoleranz nach DIN 1420

Engineering data

- unequal division
- short bevel
- design as specified acc. DIN 1420

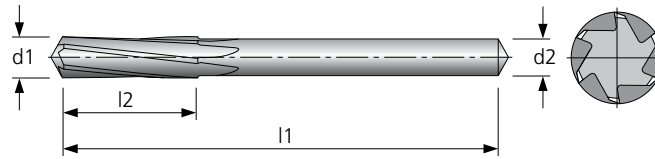

Material	Alu Knet- leg.	Alu Guss- leg.	Stahl < 800 N/mm ²	Stahl < 1200 N/mm ²	Stahl < 1600 N/mm ²	Stahl < 55 HRC	Stahl < 60 HRC	Stahl < 66 HRC	INOX < 800 N/mm ²	INOX > 800 N/mm ²	GG	G GG	hochw. Legie- rungen	Titan	NE- Metalle Cu-Leg.	Graphit & Faser- verbund	MMS	max.	ohne	AIR
50-1080	●	●	●	●	●	●			○	○	●	●	○	●	●		○	●	○	

Schnittdaten siehe Seite / cutting data available on page - 178

● sehr gut geeignet / very suitable ○ bedingt geeignet / limited suitable

Ø d1 (H7) mm	50-1080	Ø d1 von ... bis	l2 mm	l1 mm	Z	Ø d2 (h6) mm	Ø d1 (H7) mm	50-1080	Ø d1 von ... bis	l2 mm	l1 mm	Z	Ø d2 (h6) mm
3		2,75 – 3,25	16	50	6	2,5	7		6,76 – 7,50	25	71	6	6,3
3,5		3,26 – 3,75	16	50	6	3	8		7,51 – 8,50	25	71	6	6,3
4		3,76 – 4,25	20	56	6	3,55	9		8,51 – 9,50	25	71	6	8
4,5		4,26 – 4,75	22	63	6	4	10		9,51 – 10,5	25	71	6	8
5		4,76 – 5,25	22	63	6	4	11		10,6 – 11,5	28	80	6	10
5,5		5,26 – 5,75	22	63	6	5	12		11,6 – 12,5	28	80	6	10
6		5,76 – 6,25	22	63	6	5	13		12,6 – 13,5	28	80	6	10
6,5		6,26 – 6,75	22	63	6	5	14		13,6 – 14,0	32	90	8	12,5

Zuschläge für Zwischenabmessungen und andere Passungen als H7 finden Sie auf Seite 237.

Extra charges for intermediate sizes and other fits than H7 can be found on page 237.

Bestellbeispiel / Order example: 50-1080-7

Diamant-Fräser

diamond end mills



Polykristalline Diamant-Fräswerkzeuge für optimale Standzeiten speziell in Aluminium, Graphit und Faserverbundwerkstoffen.

Polycrystalline diamond end mills for optimal tool life especially for aluminium, graphite, composite and glassfibre materials.



Schaftfräser

solid carbide end mills

Vollhartmetall-Schaftfräser zum Nuten und Umfangfräsen in verschiedenen Ausführungen.

Solid carbide end mills for slot and periphery milling in different types.

HAM 40-1000

Vollhartmetall-Schaftfräser
solid carbide end mill

VHM Z 1 30° rechts Werk Norm
Typ W HA
SHRINK FIT

Konstruktions-Daten

- Zentrumsschneide
- Spanwinkel stark positiv
- großer Spanraum
- speziell zum Fräsen von Kunststoff

Engineering data

- centre cutting
- rake angle very positive
- big chip space
- especially for machining of plastics

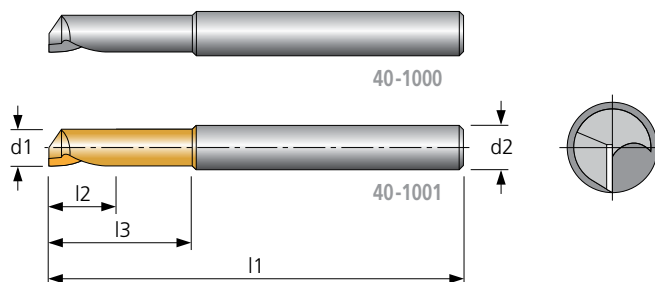

Material	Alu Knet-leg.	Alu Guss-leg.	Stahl < 800 N/mm²	Stahl < 1200 N/mm²	Stahl < 1600 N/mm²	Stahl < 55 HRC	Stahl < 60 HRC	Stahl < 66 HRC	INOX < 800 N/mm²	INOX > 800 N/mm²	GG	GGG	hochw. Legierungen	Titan	NE-Metalle Cu-Leg.	Graphit & Faser-verbund	MMS	max.	ohne	AIR
40-1000	●	○													●	○	●	●	○	○
40-1001	●	●													○	○	●	●	○	○

Schnittdaten siehe Seite / cutting data available on page – 180

● sehr gut geeignet / very suitable ○ bedingt geeignet / limited suitable

Ø d1 (f10) mm	40-1000	40-1001	l2 mm	l3 mm	l1 mm	Ø d2 (h6) mm	Ø d1 (f10) mm	40-1000	40-1001	l2 mm	l3 mm	l1 mm	Ø d2 (h6) mm
		TA-AL							TA-AL				
0,3			2	3	38	3	2,5			9	12	38	3
0,4			2,5	3,5	38	3	3			12	13	38	3
0,6			2,5	3,5	38	3	4			12	15	50	6
0,8			4	5	38	3	5			14	17	50	6
1			4	5	38	3	6			16	17	50	6
1,2			5	6	38	3	8			20	21	60	8
1,5			6	7	38	3	10			22	23	70	10
1,6			6	7	38	3							
1,8			7	10	38	3							
2			8	11	38	3							

Bestellbeispiel / Order example: 40-1000-2,5

HAM 40-1040

Vollhartmetall-Schaftfräser solid carbide end mill

VHM Z 2 30° rechts Werk Norm
Typ W DIN 6535 HA
HSF SHRINK FIT

Konstruktions-Daten

- spezielle Geometrie für Aluminium
- großer Spanraum
- zentrumsschneidend

Engineering data

- special geometry for aluminium
- big chip space
- centre cutting

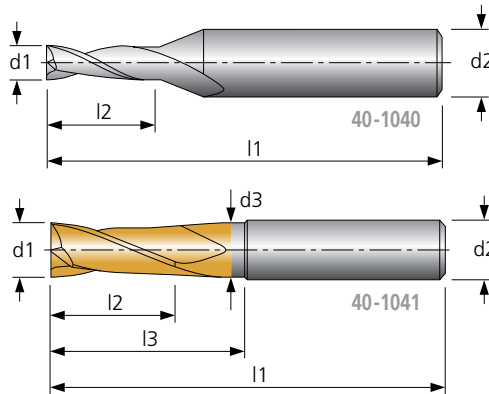

Eckenfase	d1	b
	≤ Ø 8 ≥ Ø 10	— 0,10

Material	Alu Knet-leg.	Alu Guss-leg.	Stahl < 800 N/mm²	Stahl < 1200 N/mm²	Stahl < 1600 N/mm²	Stahl < 55 HRC	Stahl < 60 HRC	Stahl < 66 HRC	INOX < 800 N/mm²	INOX > 800 N/mm²	GG	GGG	hochw. Legierungen	Titan	NE-Metalle Cu-Leg.	Graphit & Faser-verbund	MMS	max.	ohne	AIR
40-1040	●	○													●	○	●	●	○	○
40-1041	●	●													○	○	●	●	○	○

Schnittdaten siehe Seite / cutting data available on page – 181

● sehr gut geeignet / very suitable ○ bedingt geeignet / limited suitable

Ø d1 (e8) mm	40-1040	40-1041	l2 mm	l3 mm	Hals Ø d3 mm	l1 mm	Ø d2 (h6) mm	Ø d1 (e8) mm	40-1040	40-1041	l2 mm	l3 mm	Hals Ø d3 mm	l1 mm	Ø d2 (h6) mm
		TA-AL								TA-AL					
1			6	—	—	57	6	10			14	—	—	66	10
2			8	—	—	57	6	10			22	—	—	72	10
3			5	—	—	50	6	10			35	60	9,6	120	10
3			8	—	—	57	6	12			16	—	—	73	12
3			12	—	—	60	6	12			26	—	—	83	12
4			8	—	—	54	6	12			40	75	11,6	120	12
4			11	—	—	57	6	14			18	—	—	75	14
4			16	—	—	60	6	14			26	—	—	83	14
5			9	—	—	54	6	16			22	—	—	82	16
5			13	—	—	57	6	16			32	—	—	92	16
5			20	—	—	60	6	16			50	102	15,6	150	16
6			10	—	—	54	6	18			24	—	—	84	18
6			13	—	—	57	6	18			32	—	—	92	18
6			25	40	5,8	100	6	20			26	—	—	92	20
8			12	—	—	58	8	20			38	—	—	104	20
8			16	—	—	63	8	20			60	100	19,6	150	20
8			30	50	7,7	100	8								

Bestellbeispiel / Order example: 40-1040-10-14

HAM 40-5380

NEU

Vollhartmetall-Schaftfräser
solid carbide end mill

VHM Z 3 45° rechts Werk Norm
 Typ W DIN 6535 HA
 HSF HSC HPC SHRINK FIT
 DIN 6535 HB

Konstruktions-Daten

- spezielle Geometrie mit ungleicher Drallsteigung
- hohes Zeitspanvolumen und max. Zustellung im Vollschnitt (bis 1,5 x D)
- hohe Laufruhe und vibrationsarme Bearbeitung
- Schneidbereich geometrisch gewuchtet
- mit einer zentralen Innenkühlung
- nicht zum Bohren geeignet

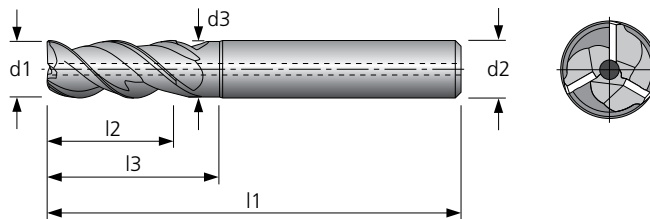

Engineering data

- special geometry with unequal helix
- high chipping volume (up to 1,5 x D)
- very smooth running and very little vibrations during machining
- cutting area geometrical balanced
- with one central internal coolant
- not suitable for drilling

Eckenfase	d1	b
	≤ Ø 5 ≥ Ø 6	0,10 0,20

Material	Alu Knet-leg.	Alu Guss-leg.	Stahl < 800 N/mm²	Stahl < 1200 N/mm²	Stahl < 1600 N/mm²	Stahl < 55 HRC	Stahl < 60 HRC	Stahl < 66 HRC	INOX < 800 N/mm²	INOX > 800 N/mm²	GG	GGG	hochw. Legierungen	Titan	NE-Metalle Cu-Leg.	Graphit & Faser-verbund	MMS	max.	ohne	AIR
40-5380	●	●													●		○	●	○	○

Schnittdaten siehe Seite / cutting data available on page – 182

● sehr gut geeignet / very suitable ○ bedingt geeignet / limited suitable

Ø d1 (f8) mm	40-5380	l2 mm	l3 mm	Hals Ø d3 mm	l1 mm	Ø d2 (h6) mm
6		13	18	5,8	57	6
8		19	25	7,7	63	8
10		22	30	9,7	72	10

Ø d1 (f8) mm	40-5380	l2 mm	l3 mm	Hals Ø d3 mm	l1 mm	Ø d2 (h6) mm
12		26	36	11,7	83	12
16		32	42	15,6	92	16
20		38	52	19,6	104	20

Bestellbeispiel / Order example: HA-Schaft/shank 40-5380-12
 HB-Schaft/shank 40-5380-12-HB

HAM 40-5390

Vollhartmetall-Schaftfräser solid carbide end mill

VHM Z 3 45° rechts Werk Norm
Typ W DIN 6535 HA
HSF HSC HPC SHRINK FIT
DIN 6535 HB

Konstruktions-Daten

- spezielle Geometrie mit ungleicher Drallsteigung
- hohes Zeitspanvolumen und max. Zustellung im Vollschnitt (bis 1,5 x D)
- hohe Laufruhe und vibrationsarme Bearbeitung
- Schneidbereich geometrisch gewuchtet

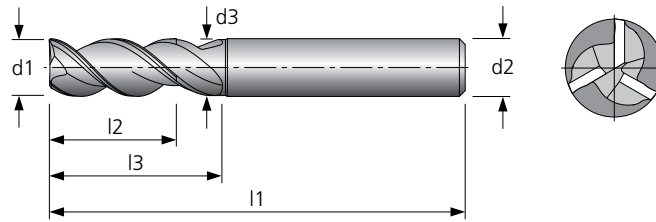

Engineering data

- special geometry with unequal helix
- high chipping volume (up to 1,5 x D)
- very smooth running and very little vibrations during machining
- cutting area geometrical balanced

Eckenfase	d1	b
	≤ Ø 5 ≥ Ø 6	0,10 0,20

Material	Alu Knet-leg.	Alu Guss-leg.	Stahl < 800 N/mm²	Stahl < 1200 N/mm²	Stahl < 1600 N/mm²	Stahl < 55 HRC	Stahl < 60 HRC	Stahl < 66 HRC	INOX < 800 N/mm²	INOX > 800 N/mm²	GG	GGG	hochw. Legierungen	Titan	NE-Metalle Cu-Leg.	Graphit & Faser-verbund	MMS	max.	ohne	AIR
40-5390	●	●													●		○	●	○	○

Schnittdaten siehe Seite / cutting data available on page – 183

● sehr gut geeignet / very suitable ○ bedingt geeignet / limited suitable

Ø d1 (f8) mm	40-5390	l2 mm	l3 mm	Hals Ø d3 mm	l1 mm	Ø d2 (h6) mm
3		8	12	2,8	57	6
4		11	18	3,8	57	6
5		13	18	4,8	57	6
6		13	18	5,8	57	6
6		13	42	5,8	80	6
8		19	25	7,7	63	8
8		19	62	7,7	100	8
10		22	30	9,7	72	10
10		22	60	9,7	100	10

Ø d1 (f8) mm	40-5390	l2 mm	l3 mm	Hals Ø d3 mm	l1 mm	Ø d2 (h6) mm
12		26	36	11,7	83	12
12		26	73	11,7	120	12
16		32	42	15,6	92	16
16		32	100	15,6	150	16
20		38	52	19,6	104	20
20		38	100	19,6	150	20

Bestellbeispiel / Order example: HA-Schaft / shank 40-5390-12-36
HB-Schaft / shank 40-5390-12-36-HB

HAM 40-5490

Vollhartmetall-Schaftfräser solid carbide end mill

VHM Z 3 45° rechts Werk Norm
 Typ W DIN 6535 HA
 HSF HSC HPC SHRINK FIT
 Eckradius DIN 6535 HB

Konstruktions-Daten

- spezielle Geometrie mit ungleicher Drallsteigung
- hohes Zeitspanvolumen und max. Zustellung im Vollschnitt (bis 1,5 x D)
- hohe Laufruhe und vibrationsarme Bearbeitung
- Radiusform-Toleranz 0,02
- Schneidbereich geometrisch gewuchtet

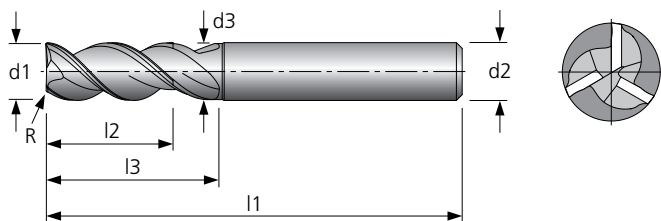

Engineering data

- special geometry with unequal helix
- high chipping volume (up to 1,5 x D)
- very smooth running and very little vibrations during machining
- radius form tolerance 0,02
- cutting area geometrical balanced

Material	Alu Knet-leg.	Alu Guss-leg.	Stahl < 800 N/mm ²	Stahl < 1200 N/mm ²	Stahl < 1600 N/mm ²	Stahl < 55 HRC	Stahl < 60 HRC	Stahl < 66 HRC	INOX < 800 N/mm ²	INOX > 800 N/mm ²	GG	GGG	hochw. Legierungen	Titan	NE-Metalle Cu-Leg.	Graphit & Faserverbund	MMS	max.	ohne	AIR
40-5490	●	●													●		○	●	○	○

Schnittdaten siehe Seite / cutting data available on page – 184

● sehr gut geeignet / very suitable ○ bedingt geeignet / limited suitable

Ø d1/R (f8) mm	40-5490	l2 mm	l3 mm	Hals Ø d3 mm	l1 mm	Ø d2 (h6) mm	Ø d1/R (f8) mm	40-5490	l2 mm	l3 mm	Hals Ø d3 mm	l1 mm	Ø d2 (h6) mm
3/0,5		8	12	2,8	57	6	12/0,5		26	36	11,7	83	12
4/0,5		11	18	3,8	57	6	12/2		26	36	11,7	83	12
4/1		11	18	3,8	57	6	12/1		26	36	11,7	83	12
5/0,5		13	18	4,8	57	6	16/0,5		32	42	15,6	92	16
5/1		13	18	4,8	57	6	16/1		32	42	15,6	92	16
6/0,5		13	18	5,8	57	6	16/2		32	42	15,6	92	16
6/1		13	18	5,8	57	6	16/3		32	42	15,6	92	16
8/0,5		19	25	7,7	63	8	20/0,5		38	52	19,6	104	20
8/1		19	25	7,7	63	8	20/1		38	52	19,6	104	20
8/2		19	25	7,7	63	8	20/2		38	52	19,6	104	20
10/0,5		22	30	9,7	72	10	20/3		38	52	19,6	104	20
10/1		22	30	9,7	72	10							
10/2		22	30	9,7	72	10							

Bestellbeispiel / Order example: HA-Schaft /shank 40-5490-12/0,5
HB-Schaft /shank 40-5490-12/0,5-HB

HAM 40-1080

Vollhartmetall-Schaftfräser solid carbide end mill

VHM
Z 2
45° rechts
DIN 6527
Typ W
HA
SHRINK FIT

Konstruktions-Daten

- zentrumsschneidend
- großer Spanraum
- Miniaturfräser

Engineering data

- centre cutting
- big chip space
- miniature end mill

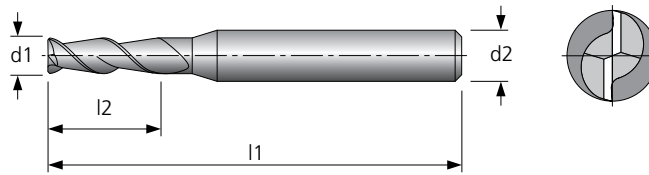

Material	Alu Knet-leg.	Alu Guss-leg.	Stahl < 800 N/mm²	Stahl < 1200 N/mm²	Stahl < 1600 N/mm²	Stahl < 55 HRC	Stahl < 60 HRC	Stahl < 66 HRC	INOX < 800 N/mm²	INOX > 800 N/mm²	GG	GGG	hochw. Legierungen	Titan	NE-Metalle Cu-Leg.	Graphit & Faser-verbund	MMS	max.	ohne	AIR
40-1080	●	●							○	○					●	○	●	●	○	○

Schnittdaten siehe Seite / cutting data available on page – 185

● sehr gut geeignet / very suitable ○ bedingt geeignet / limited suitable

Ø d1 (e8) mm	40-1080	l2 mm	l1 mm	Ø d2 (h6) mm
0,3		1	38	3
0,4		1,5	38	3
0,6		2	38	3
0,8		3	38	3
1		3	38	3
1,2		4	38	3
1,5		5	38	3

Ø d1 (e8) mm	40-1080	l2 mm	l1 mm	Ø d2 (h6) mm
1,6		5	38	3
1,8		6	38	3
2		6	38	3
2,5		7	38	3
3		7	38	3
3		7	57	6

Bestellbeispiel / Order example: 40-1080-1,6-38

HAM 40-1160

Vollhartmetall-Schaftfräser solid carbide end mill

VHM Z 2 30° rechts Werk Norm
Typ N HA
SHRINK FIT

Konstruktions-Daten

- zentrumsschneidend
- universell einsetzbar

Engineering data

- centre cutting
- allround end mill

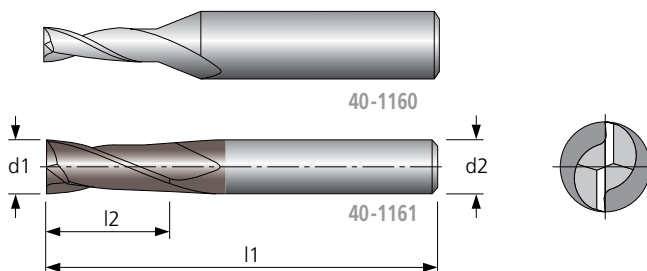

Eckenfase	d1	b
	≤ Ø 8	—
	= Ø 9	0,05
	≥ Ø 10	0,10

Material	Alu Knet-leg.	Alu Guss-leg.	Stahl < 800 N/mm²	Stahl < 1200 N/mm²	Stahl < 1600 N/mm²	Stahl < 55 HRC	Stahl < 60 HRC	Stahl < 66 HRC	INOX < 800 N/mm²	INOX > 800 N/mm²	GG	GGG	hochw. Legierungen	Titan	NE-Metalle Cu-Leg.	Graphit & Faser-verbund	MMS	max.	ohne	AIR
40-1160	○	○	●	○	○				○	○	●	○	○	○	○		●	●	○	○
40-1161	○	○	●	●	○				○	○	●	●	○	○	○		●	●	○	○

Schnittdaten siehe Seite / cutting data available on page – 186

● sehr gut geeignet / very suitable ○ bedingt geeignet / limited suitable

Ø d1 (e8) mm	40-1160	40-1161	l2 mm	l1 mm	Ø d2 (h6) mm
		TA			
0,3			1	38	3
0,4			2,5	38	3
0,5			2,5	38	3
0,6			3	38	3
0,8			4	38	3
1			5	38	3
1,2			5	38	3
1,5			5	38	3
1,6			6	38	3
1,8			6	38	3
2			9	38	3
2,4			10	38	3
2,5			10	38	3
2,8			10	38	3
3			12	38	3

Ø d1 (e8) mm	40-1160	40-1161	l2 mm	l1 mm	Ø d2 (h6) mm
		TA			
3			7	57	6
3,5			12	40	3,5
4			12	40	4
5			14	50	5
6			16	50	6
7			20	60	7
8			20	60	8
9			22	70	9
10			22	70	10
11			22	70	11
12			22	70	12
14			25	75	14
16			25	75	16
18			30	100	18
20			30	100	20

Bestellbeispiel / Order example: 40-1160-3-57

HAM 40-1201

Vollhartmetall-Schaftfräser solid carbide end mill

VHM Z 2 30° rechts DIN 6527
Typ N DIN 6535 HA
SHRINK FIT
DIN 6535 HB

Konstruktions-Daten

- zentrumsschneidend
- universell einsetzbar

Engineering data

- centre cutting
- allround end mill

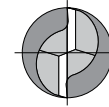
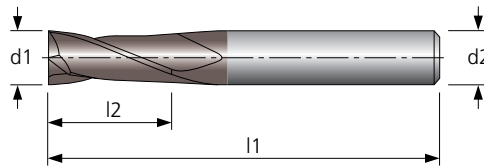

Eckenfase	d1	b
	≤ Ø 8	—
	= Ø 9	0,05
	≥ Ø 10	0,10

Material	Alu Knet-leg.	Alu Guss-leg.	Stahl < 800 N/mm²	Stahl < 1200 N/mm²	Stahl < 1600 N/mm²	Stahl < 55 HRC	Stahl < 60 HRC	Stahl < 66 HRC	INOX < 800 N/mm²	INOX > 800 N/mm²	GG	GGG	hochw. Legierungen	Titan	NE-Metalle Cu-Leg.	Graphit & Faser-verbund	MMS	max.	ohne	AIR	
40-1201		○	●	●	○				○	○	●	●	○	○	○			●	●	○	○

Schnittdaten siehe Seite / cutting data available on page – 187

● sehr gut geeignet / very suitable ○ bedingt geeignet / limited suitable

Ø d1 (e8) mm	40-1201	l2 mm	l1 mm	Ø d2 (h6) mm
	TA			
2		6	57	6
3		7	57	6
4		8	57	6
5		10	57	6
6		10	57	6

Ø d1 (e8) mm	40-1201	l2 mm	l1 mm	Ø d2 (h6) mm
	TA			
7		13	63	8
8		16	63	8
9		16	72	10
10		19	72	10
12		22	83	12

Bestellbeispiel / Order example: HA-Schaft/shank 40-1201-7
HB-Schaft/shank 40-1201-7-HB

HAM 40-1280

Vollhartmetall-Schaftfräser solid carbide end mill

VHM Z 3 30° rechts Werk Norm
Typ N HA
SHRINK FIT
HB

Konstruktions-Daten

- bis Ø 3,0 mm, zentrumsschneidend
- ab Ø 3,5 mm, eine Schneide über Mitte
- universell einsetzbar

Engineering data

- up to Ø 3,0 mm, centre cutting
- from Ø 3,5 mm, 1 cutting edge over centre
- allround end mill

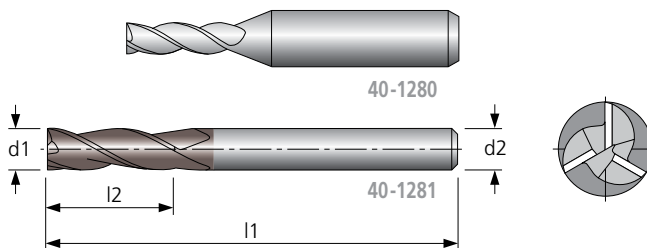

Eckenfase	d1	b
	≤ Ø 8	—
	= Ø 9	0,05
	≥ Ø 10	0,10

Material	Alu Knet-leg.	Alu Guss-leg.	Stahl < 800 N/mm²	Stahl < 1200 N/mm²	Stahl < 1600 N/mm²	Stahl < 55 HRC	Stahl < 60 HRC	Stahl < 66 HRC	INOX < 800 N/mm²	INOX > 800 N/mm²	GG	GGG	hochw. Legierungen	Titan	NE-Metalle Cu-Leg.	Graphit & Faser-verbund	MMS	max.	ohne	AIR
40-1280	○	○	●	○	○	○			○	○	●	○	○	○	○		●	●	○	○
40-1281	○	○	●	●	●	○			○	○	●	●	○	○	○		●	●	○	○

Schnittdaten siehe Seite / cutting data available on page – 188

● sehr gut geeignet / very suitable ○ bedingt geeignet / limited suitable

Ø d1 (e8) mm	40-1280	40-1281	l2 mm	l1 mm	Ø d2 (h6) mm	Ø d1 (e8) mm	40-1280	40-1281	l2 mm	l1 mm	Ø d2 (h6) mm
		TA						TA			
0,6			2	38	3	5			14	50	5
0,8			3	38	3	6			16	50	6
1			3	38	3	7			20	60	7
1,2			4	38	3	8			20	60	8
1,5			5	38	3	9			22	70	9
1,6			5	38	3	10			22	70	10
2			6	38	3	11			22	70	11
2,5			7	38	3	12			22	70	12
3			9	38	3	14			25	75	14
3,5			12	40	3,5	16			25	75	16
4			12	40	4	18			30	100	18
4,5			14	50	4,5	20			30	100	20

Bestellbeispiel / Order example: HA-Schaft/shank 40-1280-5
HB-Schaft/shank 40-1280-6-HB

HAM 40-1321

Vollhartmetall-Schaftfräser solid carbide end mill

VHM Z 3 30° rechts DIN 6527
Typ N DIN 6535 HA
SHRINK FIT
DIN 6535 HB

- Konstruktions-Daten**
- eine Schneide über Mitte
 - verstärkter Kern

- Engineering data**
- 1 cutting edge over centre
 - reinforced web thickness

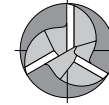
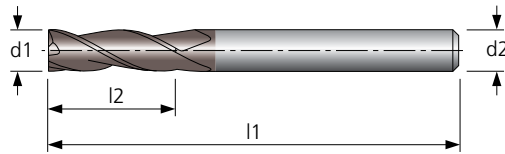

Eckenfase	d1	b
	≤ Ø 8	—
	= Ø 9	0,05
	≥ Ø 10	0,10

Material	Alu Knet-leg.	Alu Guss-leg.	Stahl < 800 N/mm²	Stahl < 1200 N/mm²	Stahl < 1600 N/mm²	Stahl < 55 HRC	Stahl < 60 HRC	Stahl < 66 HRC	INOX < 800 N/mm²	INOX > 800 N/mm²	GG	GGG	hochw. Legierungen	Titan	NE-Metalle Cu-Leg.	Graphit & Faser-verbund	MMS	max.	ohne	AIR	
40-1321		○	●	●	●	○			○	○	●	●	○	○	○			●	●	○	○

Schnittdaten siehe Seite / cutting data available on page – 189

● sehr gut geeignet / very suitable ○ bedingt geeignet / limited suitable

Ø d1 (e8) mm	40-1321	l2 mm	l1 mm	Ø d2 (h6) mm
	TA			
3		7	57	6
4		8	57	6
5		10	57	6
6		10	57	6
7		13	63	8
8		16	63	8

Ø d1 (e8) mm	40-1321	l2 mm	l1 mm	Ø d2 (h6) mm
	TA			
10		19	72	10
12		22	83	12
14		22	83	14
16		26	92	16
18		26	92	18
20		32	104	20

Bestellbeispiel / Order example: HA-Schaft/shank 40-1321-10
 HB-Schaft/shank 40-1321-10-HB

HAM 40-1360

Vollhartmetall-Schaftfräser mit verdrehtem Kühlkanal
solid carbide end mill with interior coolant supply

VHM Z 3 30° rechts DIN 6527
Typ N DIN 6535 PHAK
SHRINK FIT
DIN 6535 HBK

Konstruktions-Daten

- eine Schneide über Mitte
- verstärkter Kern

Engineering data

- 1 cutting edge over centre
- reinforced web thickness

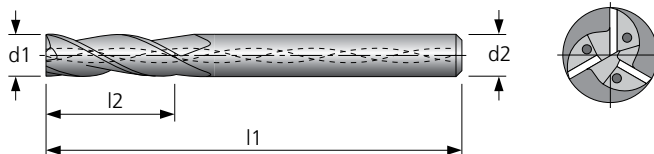

Eckenfase	d1	b
	≤ Ø 8	—
	= Ø 9	0,05
	≥ Ø 10	0,10

Material	Alu Knet-leg.	Alu Guss-leg.	Stahl < 800 N/mm²	Stahl < 1200 N/mm²	Stahl < 1600 N/mm²	Stahl < 55 HRC	Stahl < 60 HRC	Stahl < 66 HRC	INOX < 800 N/mm²	INOX > 800 N/mm²	GG	GGG	hochw. Legierungen	Titan	NE-Metalle Cu-Leg.	Graphit & Faser-verbund	MMS	max.	ohne	AIR
40-1360		○	●	●	●	○			○	○	●	●	○	○	○		●	●	○	○

Schnittdaten siehe Seite / cutting data available on page – 190

● sehr gut geeignet / very suitable ○ bedingt geeignet / limited suitable

Ø d1 (e8) mm	40-1360	l2 mm	l1 mm	Ø d2 (h6) mm
8		16	63	8
9		16	72	10
10		19	72	10
12		22	83	12

Ø d1 (e8) mm	40-1360	l2 mm	l1 mm	Ø d2 (h6) mm
14		22	83	14
16		26	92	16
18		26	92	18
20		32	104	20

Bestellbeispiel / Order example: HAK-Schaft/shank 40-1360-14
 HBK-Schaft/shank 40-1360-14-HBK

HAM 40-1400

Vollhartmetall-Schaftfräser solid carbide end mill

VHM Z 3 45° rechts Werk Norm
 Typ N HA
 SHRINK FIT
 HB

Konstruktions-Daten

- bis Ø d1 3,0 mm und Ø d2 3,0 mm
3 Schneiden bis Mitte schneidend
- ab Ø d1 3,0 mm und Ø d2 6,0 mm
eine Schneide über Mitte schneidend

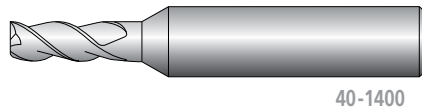

Engineering data

- up to Ø d1 3,0 mm and Ø d2 3,0 mm
3 cutting edges centre cutting
- from Ø d1 3,0 mm and Ø d2 6,0 mm
1 cutting edge over centre

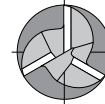
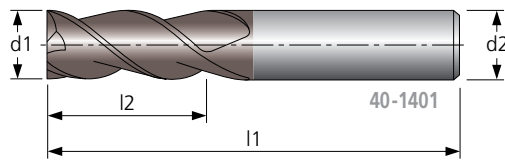

Eckenfase	d1	b
	≥ Ø 4	0,05
	≥ Ø 8	0,10
	≥ Ø 14	0,15
	≥ Ø 18	0,20

Material	Alu Knet-leg.	Alu Guss-leg.	Stahl < 800 N/mm²	Stahl < 1200 N/mm²	Stahl < 1600 N/mm²	Stahl < 55 HRC	Stahl < 60 HRC	Stahl < 66 HRC	INOX < 800 N/mm²	INOX > 800 N/mm²	GG	GGG	hochw. Legierungen	Titan	NE-Metalle Cu-Leg.	Graphit & Faser-verbund	MMS	max.	ohne	AIR
40-1400	○	○	●	○	○				●	○	●	○	○	○	○		●	●	○	○
40-1401	○	○	●	●	○				●	●	●	●	○	○	○		●	●	○	○

Schnittdaten siehe Seite / cutting data available on page – 191

● sehr gut geeignet / very suitable ○ bedingt geeignet / limited suitable

Ø d1 (e8) mm	40-1400	40-1401	l2 mm	l1 mm	Ø d2 (h6) mm
		TA			
0,4			2	38	3
0,6			2	38	3
0,8			3	38	3
1			3	38	3
1,2			4	38	3
1,5			5	38	3
1,6			5	38	3
1,8			6	38	3
2			6	38	3
2,4			7	38	3
2,5			7	38	3
2,8			7	38	3
3			7	38	3
3			7	57	6
3,5			7	57	6
4			8	57	6
4			12	40	4

Ø d1 (e8) mm	40-1400	40-1401	l2 mm	l1 mm	Ø d2 (h6) mm
		TA			
4,5			8	57	6
5			14	50	5
5			10	57	6
5,75			10	57	6
6			10	57	6
7			13	63	8
8			16	63	8
9			16	72	10
10			19	72	10
12			22	83	12
14			22	83	14
16			26	92	16
18			26	92	18
20			32	104	20
25			40	110	25

Bestellbeispiel / Order example: HA-Schaft/shank 40-1400-4,5-57
 HB-Schaft/shank 40-1400-4,5-57-HB

HAM 40-1440

Vollhartmetall-Schaftfräser
solid carbide end mill

VHM
Z 4
30° rechts
Werk Norm
Typ N
HA
SHRINK FIT

Konstruktions-Daten

- zentrumsschneidend
- speziell zum Schlichten geeignet

Engineering data

- centre cutting
- especially for finishing machining

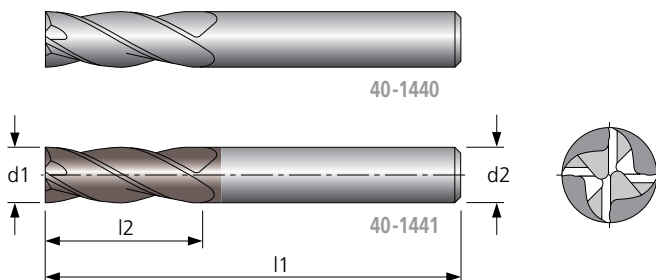

Eckenfase	d1	b
	≤ Ø 8 = Ø 9 ≥ Ø 10	— 0,05 0,10

Material	Alu Knet-leg.	Alu Guss-leg.	Stahl < 800 N/mm²	Stahl < 1200 N/mm²	Stahl < 1600 N/mm²	Stahl < 55 HRC	Stahl < 60 HRC	Stahl < 66 HRC	INOX < 800 N/mm²	INOX > 800 N/mm²	GG	GGG	hochw. Legierungen	Titan	NE-Metalle Cu-Leg.	Graphit & Faser-verbund	MMS	max.	ohne	AIR	
40-1440	○	○	●	○	○	○	○	○	○	○	●	○	○	○	○	○	○	●	●	○	○
40-1441	○	○	●	●	●	○	○	○	○	○	●	●	○	○	○	○	○	●	●	○	○

Schnittdaten siehe Seite / cutting data available on page – 192

● sehr gut geeignet / very suitable ○ bedingt geeignet / limited suitable

Ø d1 (e8) mm	40-1440	40-1441	l2 mm	l1 mm	Ø d2 (h6) mm
	TA				
2			5	38	3
2,5			5,5	38	3
3			10	38	3
3,5			12	40	3,5
4			12	40	4
4,5			14	50	4,5
5			14	50	5
6			16	50	6
7			20	60	7

Ø d1 (e8) mm	40-1440	40-1441	l2 mm	l1 mm	Ø d2 (h6) mm
	TA				
8			20	60	8
9			20	60	9
10			22	70	10
11			22	70	11
12			22	70	12
14			25	75	14
16			25	75	16
18			38	104	18
20			38	104	20

Bestellbeispiel / Order example: 40-1440-8

HAM 40-5151

Vollhartmetall-Schaftfräser solid carbide end mill

W+F VHM Z 4 35°/38° re DIN 6527
Typ N DIN 6535 HA
HSF HPC SHRINK FIT
DIN 6535 HB

- Konstruktions-Daten**
- zentrumsschneidend
 - spezielle Geometrie mit ungleicher Drallsteigung
 - hohes Zeitspanvolumen
 - hohe Laufruhe

- Engineering data**
- centre cutting
 - special geometry with unequal helix
 - high chipping volume
 - very smooth running

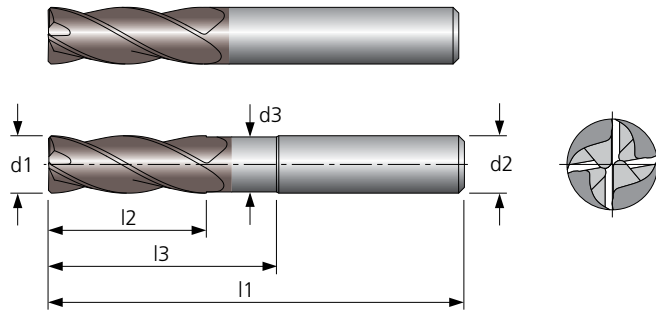

Eckenfase	d1	b
	= Ø 3 ≥ Ø 4	0,08 0,02 x d1

Material	Alu Knet-leg.	Alu Guss-leg.	Stahl < 800 N/mm²	Stahl < 1200 N/mm²	Stahl < 1600 N/mm²	Stahl < 55 HRC	Stahl < 60 HRC	Stahl < 66 HRC	INOX < 800 N/mm²	INOX > 800 N/mm²	GG	GGG	hochw. Legierungen	Titan	NE-Metalle Cu-Leg.	Graphit & Faser-verbund	MMS	max.	ohne	AIR
40-5151	○	○	●	●	●				●	●	●	●	○	●	○		●	●	○	○

Schnittdaten siehe Seite / cutting data available on page – 194

● sehr gut geeignet / very suitable ○ bedingt geeignet / limited suitable

Ø d1 (e8) mm	40-5151	l2 mm	l3 mm	Hals Ø d3 mm	l1 mm	Ø d2 (h6) mm	Ø d1 (e8) mm	40-5151	l2 mm	l3 mm	Hals Ø d3 mm	l1 mm	Ø d2 (h6) mm
	TA							TA					
3		8	13	2,9	57	6	13		26	—	—	83	14
4		11	—	—	57	6	14		18	—	—	75	14
4		11	17	3,9	57	6	14		26	—	—	83	14
5		13	—	—	57	6	14		26	38	13,6	83	14
5		13	19	4,9	57	6	15		32	—	—	92	16
6		10	—	—	54	6	16		22	—	—	82	16
6		13	—	—	57	6	16		32	—	—	92	16
6		13	21	5,7	57	6	16		32	44	15,6	92	16
7		19	—	—	63	8	18		24	—	—	84	18
8		12	—	—	58	8	18		32	—	—	92	18
8		19	—	—	63	8	18		32	44	17,6	92	18
8		19	27	7,7	63	8	20		26	—	—	92	20
9		22	—	—	72	10	20		38	—	—	104	20
10		14	—	—	66	10	20		38	54	19,6	104	20
10		22	—	—	72	10	25		38	—	—	110	25
10		22	32	9,7	72	10	25		38	54	24,5	110	25
11		26	—	—	83	12	26		45	—	—	115	25
12		16	—	—	73	12							
12		26	—	—	83	12							
12		26	38	11,7	83	12							

Bestellbeispiel / Order example: HA-Schaft/shank 40-5151-14-26-38
HB-Schaft/shank 40-5151-14-26-38-HB

HAM 40-5181

Vollhartmetall-Schaftfräser solid carbide end mill

W+F
 VHM
 Z 4
 35°/38° re
 DIN 6527
 Typ N
 DIN 6535 HA
 HSF
 Eckradius
 HPC
 SHRINK FIT
 DIN 6535 HB

Konstruktions-Daten

- zentrumsschneidend
- spezielle Geometrie mit ungleicher Drallsteigung
- hohes Zeitspanvolumen
- hohe Laufruhe
- Radiusform-Toleranz 0,02

Engineering data

- centre cutting
- special geometry with unequal helix
- high chipping volume
- very smooth running
- radius form tolerance 0,02

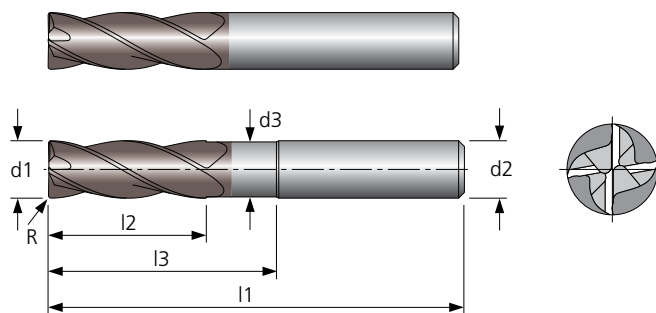

Material	Alu Knet-leg.	Alu Guss-leg.	Stahl < 800 N/mm²	Stahl < 1200 N/mm²	Stahl < 1600 N/mm²	Stahl < 55 HRC	Stahl < 60 HRC	Stahl < 66 HRC	INOX < 800 N/mm²	INOX > 800 N/mm²	GG	GGG	hochw. Legierungen	Titan	NE-Metalle Cu-Leg.	Graphit & Faser-verbund	MMS	max.	ohne	AIR
40-5181	○	○	●	●	●				●	●	●	●	○	●	○		●	●	○	○

Schnittdaten siehe Seite / cutting data available on page – 195

● sehr gut geeignet / very suitable ○ bedingt geeignet / limited suitable

Ø d1/R (e8) mm	40-5181	l2 mm	l3 mm	Hals Ø d3 mm	l1 mm	Ø d2 (h6) mm
	TA					
4/0,5		11	—	—	57	6
5/0,5		13	—	—	57	6
6/0,5		13	21	5,7	57	6
6/1		13	21	5,7	57	6
8/0,5		19	27	7,7	63	8
8/1		19	27	7,7	63	8
10/0,5		22	32	9,7	72	10
10/1		22	32	9,7	72	10

Ø d1/R (e8) mm	40-5181	l2 mm	l3 mm	Hals Ø d3 mm	l1 mm	Ø d2 (h6) mm
	TA					
12/0,5		26	38	11,7	83	12
12/1		26	38	11,7	83	12
16/1		32	44	15,6	92	16
16/2		32	44	15,6	92	16
20/1		38	54	19,6	104	20
20/2		38	54	19,6	104	20

Bestellbeispiel / Order example: HA-Schaft/shank 40-5181-12/0,5
HB-Schaft/shank 40-5181-12/0,5-HB

HAM 40-1491

Vollhartmetall-Schaftfräser solid carbide end mill

W+F VHM Z 4 35°/38° re DIN 6527

Typ N HA

HSF HSC HPC SHRINK FIT

DIN 6535 HB

Konstruktions-Daten

- spezielle Geometrie mit gleicher Teilung und ungleicher Drallsteigung
- vibrationsfreier Lauf
- geringe Auslenkung

Engineering data

- special geometry with equal pitch and unequal helix
- vibration-free running
- slightly deflection

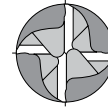
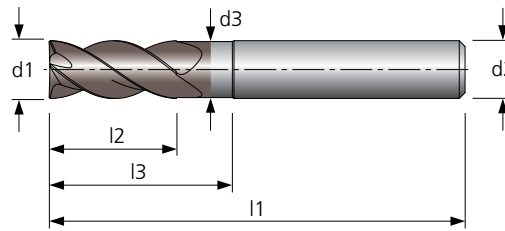

Eckenfase	d1	b
	= Ø 3 ≥ Ø 4	0,08 0,02 x d1

Material	Alu Knet-leg.	Alu Guss-leg.	Stahl < 800 N/mm²	Stahl < 1200 N/mm²	Stahl < 1600 N/mm²	Stahl < 55 HRC	Stahl < 60 HRC	Stahl < 66 HRC	INOX < 800 N/mm²	INOX > 800 N/mm²	GG	GGG	hochw. Legierungen	Titan	NE-Metalle Cu-Leg.	Graphit & Faser-verbund	MMS	max.	ohne	AIR
40-1491	○	○	●	●	●				●	●	●	●	○	●	○		●	●	○	○

Schnittdaten siehe Seite / cutting data available on page – 196

● sehr gut geeignet / very suitable ○ bedingt geeignet / limited suitable

Ø d1 (e8) mm	40-1491	l2 mm	l3 mm	Hals Ø d3 mm	l1 mm	Ø d2 (h6) mm
	TA					
3		8	13	2,9	57	6
4		11	15	3,8	57	6
5		13	20	4,8	57	6
6		13	21	5,8	57	6
8		19	27	7,5	63	8

Ø d1 (e8) mm	40-1491	l2 mm	l3 mm	Hals Ø d3 mm	l1 mm	Ø d2 (h6) mm
	TA					
10		22	32	9,5	72	10
12		26	38	11,5	83	12
16		32	44	15,5	92	16
20		38	54	19,5	104	20

Bestellbeispiel / Order example: HA-Schaft / shank 40-1491-10-22
HB-Schaft / shank 40-1491-10-22-HB

HAM 40-1521

Vollhartmetall-Schaftfräser solid carbide end mill

VHM Z 4 45° rechts DIN 6527
Typ N DIN 6535 HA
HSF SHRINK FIT
DIN 6535 HB

Konstruktions-Daten

- zentrumsschneidend
- speziell zum Schlichten geeignet
- hohe Laufruhe

Engineering data

- centre cutting
- especially for finishing machining
- very smooth running

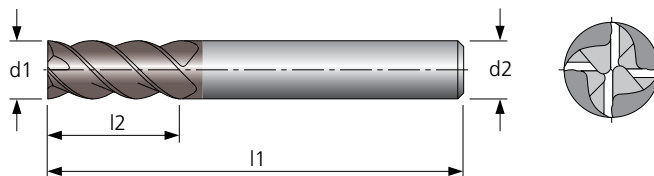

Eckenfase	d1	b
	≤ Ø 3,5	—
	≤ Ø 7	0,05
	≥ Ø 8	0,10
	≥ Ø 14	0,15
	≥ Ø 18	0,20

Material	Alu Knet-leg.	Alu Guss-leg.	Stahl < 800 N/mm²	Stahl < 1200 N/mm²	Stahl < 1600 N/mm²	Stahl < 55 HRC	Stahl < 60 HRC	Stahl < 66 HRC	INOX < 800 N/mm²	INOX > 800 N/mm²	GG	GGG	hochw. Legierungen	Titan	NE-Metalle Cu-Leg.	Graphit & Faser-verbund	MMS	max.	ohne	AIR
40-1521	○	○	●	●	○				●	●	●	●	○	●	○		●	●	○	○

Schnittdaten siehe Seite / cutting data available on page – 197

● sehr gut geeignet / very suitable ○ bedingt geeignet / limited suitable

Ø d1 (e8) mm	40-1521	l2 mm	l1 mm	Ø d2 (h6) mm
	TA			
3		7	57	6
3,5		8	57	6
4		9	57	6
4,5		10	57	6
5		12	57	6
6		13	57	6
7		15	63	8
8		19	63	8
9		19	72	10
10		22	72	10

Ø d1 (e8) mm	40-1521	l2 mm	l1 mm	Ø d2 (h6) mm
	TA			
11		24	83	12
12		26	83	12
13		26	83	14
14		26	83	14
16		32	92	16
18		32	92	18
20		38	104	20
25		38	110	25

Bestellbeispiel / Order example: HA-Schaft/shank 40-1521-11
HB-Schaft/shank 40-1521-11-HB

HAM 40-5110

Vollhartmetall-Schaftfräser solid carbide end mill

W+F VHM Z 4-6 40° rechts Werk Norm
Typ N DIN 6535 HA
HSF SHRINK FIT
DIN 6535 HB

Konstruktions-Daten

- zentrumsschneidend
- lange Schneidlänge
- verstärkter Kern

Engineering data

- centre cutting
- long cutting length
- reinforced web thickness

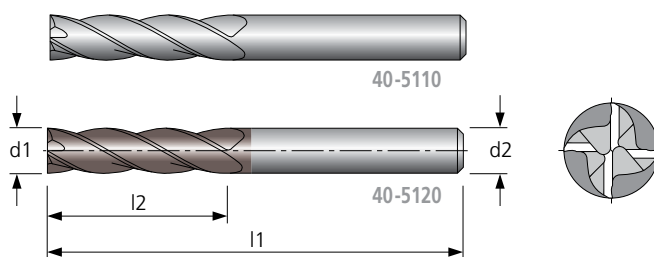

Eckenfase	d1	b
45°	= Ø 6 ≥ Ø 8 ≥ Ø 14 ≥ Ø 18	0,05 0,10 0,15 0,20

Material	Alu Knet-leg.	Alu Guss-leg.	Stahl < 800 N/mm²	Stahl < 1200 N/mm²	Stahl < 1600 N/mm²	Stahl < 55 HRC	Stahl < 60 HRC	Stahl < 66 HRC	INOX < 800 N/mm²	INOX > 800 N/mm²	GG	GGG	hochw. Legierungen	Titan	NE-Metalle Cu-Leg.	Graphit & Faser-verbund	MMS	max.	ohne	AIR
40-5110 / 40-5130	○	○	●	○	○				○	○	●	○	○	○	○		●	●	○	○
40-5120 / 40-5140	○	○	●	●	●	○			○	○	●	●	○	○	○		●	●	○	○

Schnittdaten siehe Seite / cutting data available on page – 198

● sehr gut geeignet / very suitable ○ bedingt geeignet / limited suitable

Ø d1 (e8) mm	40-5110	40-5120	40-5130	40-5140	l2 mm	l1 mm	Z	Ø d2 (h6) mm
	DIN 6535 HA	DIN 6535 HA TA	DIN 6535 HB	DIN 6535 HB TA				
6					40	100	4	6
8					40	100	4	8
10					40	100	4	10
12					45	100	4	12
14					45	100	4	14
14					65	150	4	14
16					45	100	4	16
16					65	150	4	16
18					50	125	4	18
18					65	150	4	18
20					55	125	4	20
20					80	150	4	20
20					110	180	4	20
25					55	125	6	25
25					80	150	6	25
25					110	180	6	25
25					150	230	6	25
32					110	180	6	32

Bestellbeispiel / Order example: HA-Schaft/shank 40-5110-6-40
HB-Schaft/shank 40-5130-6-40

HAM 40-5091

Vollhartmetall-Schaftfräser solid carbide end mill

W+F VHM Z 5 38° rechts Werk Norm
Typ N DIN 6535 HA
HSF HSC HPC SHRINK FIT
DIN 6535 HB

Konstruktions-Daten

- spezielle Geometrie mit ungleicher Drallsteigung
- hohes Zeitspanvolumen
- hohe Laufruhe
- zentrumsschneidend
- Schneidbereich geometrisch gewuchtet

Engineering data

- special geometry with unequal helix
- high chipping volume
- very smooth running
- centre cutting
- cutting area geometrical balanced

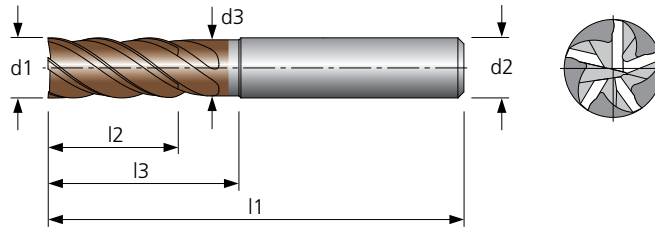

Eckenfase	d1	b
	≥ Ø 6	0,02 x d1

Material	Alu Knet-leg.	Alu Guss-leg.	Stahl < 800 N/mm²	Stahl < 1200 N/mm²	Stahl < 1600 N/mm²	Stahl < 55 HRC	Stahl < 60 HRC	Stahl < 66 HRC	INOX < 800 N/mm²	INOX > 800 N/mm²	GG	GGG	hochw. Legierungen	Titan	NE-Metalle Cu-Leg.	Graphit & Faserverbund	MMS	max.	ohne	AIR
40-5091			●	●	●				●	●	●	●	○	○			●	●	○	○

Schnittdaten siehe Seite / cutting data available on page – 199

● sehr gut geeignet / very suitable ○ bedingt geeignet / limited suitable

Ø d1 (e8) mm	40-5091	l2 mm	l3 mm	Hals Ø d3 mm	l1 mm	Ø d2 (h6) mm
	TA-B					
6		13	21	5,8	57	6
8		19	27	7,5	63	8
10		22	32	9,5	72	10

Ø d1 (e8) mm	40-5091	l2 mm	l3 mm	Hals Ø d3 mm	l1 mm	Ø d2 (h6) mm
	TA-B					
12		26	38	11,5	83	12
16		32	44	15,5	92	16
20		38	54	19,5	104	20

Bestellbeispiel / Order example: HA-Schaft / shank 40-5091-12
HB-Schaft / shank 40-5091-12-HB

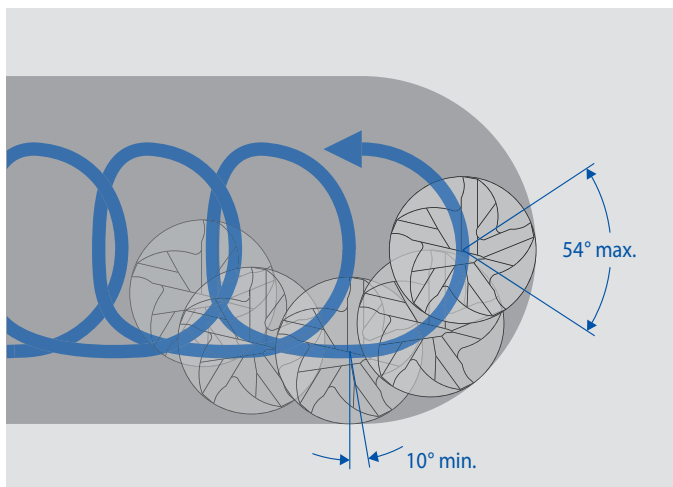

Trochoidal-Fräsen / Trochoidal milling

$h_m = \text{konstant}$ ($h_m = \text{Mittenspanndicke}$)
 $h_m = \text{constant}$ ($h_m = \text{mean chip thickness}$)

Überlagerung der Vorschubbewegung mit einer Kreisbewegung
Overlapping of feed motion with a circular movement

Besonders geeignet zum Trochoidal- und Hochgeschwindigkeits-Fräsen
Particularly suitable for trochoidal and highspeed milling

HAM 40-5191

Vollhartmetall-Schaftfräser solid carbide end mill

W+F VHM Z 5 43° rechts Werk Norm
Typ N DIN 6535 HA
HSF HSC HPC SHRINK FIT
DIN 6535 HB

Konstruktions-Daten

- spezielle Geometrie mit ungleicher Drallsteigung
- spezielle Spanbrecher für kurze Späne
- hohes Zeitspanvolumen
- hohe Laufruhe
- zentrumsschneidend
- Schneidbereich geometrisch gewuchtet

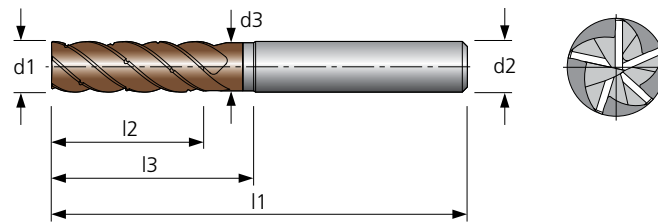

Engineering data

- special geometry with unequal helix
- special chip breaker for short chips
- high chipping volume
- very smooth running
- centre cutting
- cutting area geometrical balanced

Eckenfase	d1	b
	≥ Ø 6	0,02 x d1

Material	Alu Knet-leg.	Alu Guss-leg.	Stahl < 800 N/mm²	Stahl < 1200 N/mm²	Stahl < 1600 N/mm²	Stahl < 55 HRC	Stahl < 60 HRC	Stahl < 66 HRC	INOX < 800 N/mm²	INOX > 800 N/mm²	GG	GGG	hochw. Legierungen	Titan	NE-Metalle Cu-Leg.	Graphit & Faser-verbund	MMS	max.	ohne	AIR
40-5191			●	●	●				●	●	●	●	○	○			●	●	○	○

Schnittdaten siehe Seite / cutting data available on page – 199

● sehr gut geeignet / very suitable ○ bedingt geeignet / limited suitable

Ø d1 (e8) mm	40-5191	l2 mm	l3 mm	Hals Ø d3 mm	l1 mm	Ø d2 (h6) mm
	TA-B					
6		18	26	5,8	64	6
8		24	32	7,5	70	8
10		30	40	9,5	82	10

Ø d1 (e8) mm	40-5191	l2 mm	l3 mm	Hals Ø d3 mm	l1 mm	Ø d2 (h6) mm
	TA-B					
12		36	48	11,5	95	12
16		48	60	15,5	110	16
20		60	76	19,5	127	20

Einsatzempfehlung: Schaftausführung HB, montiert im Weldonfutter
Application recommendation: HB shank, assembled in weldon chuck

Bestellbeispiel / Order example: HA-Schaft / shank 40-5191-12
HB-Schaft / shank 40-5191-12-HB

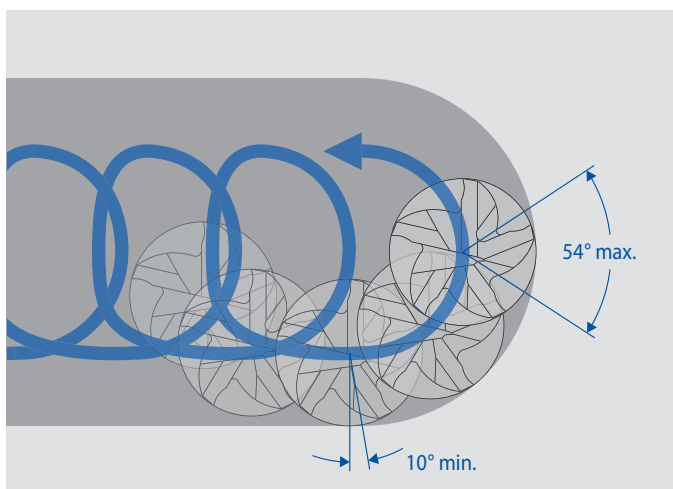

Trochoidal-Fräsen / Trochoidal milling

$h_m = \text{konstant}$ ($h_m = \text{Mittenspanndicke}$)
 $h_m = \text{constant}$ ($h_m = \text{mean chip thickness}$)

Überlagerung der Vorschubbewegung mit einer Kreisbewegung
Overlapping of feed motion with a circular movement

Besonders geeignet zum Trochoidal- und Hochgeschwindigkeits-Fräsen
Particularly suitable for trochoidal and highspeed milling

HAM 40-5291

Vollhartmetall-Schaftfräser
solid carbide end mill

W+F VHM Z 5 38° rechts Werk Norm

Typ N DIN 6535 HB

HSF HSC HPC

Konstruktions-Daten

- spezielle Geometrie mit ungleicher Drallsteigung
- spezielle Spanbrecher für kurze Späne
- hohes Zeitspanvolumen
- hohe Laufruhe
- zentrumsschneidend
- Schneidbereich geometrisch gewuchtet

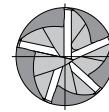
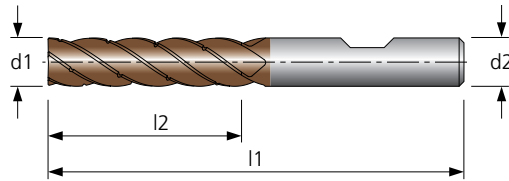

Engineering data

- special geometry with unequal helix
- special chip breaker for short chips
- high chipping volume
- very smooth running
- centre cutting
- cutting area geometrical balanced

Eckenfase	d1	b
	≥ Ø 10	0,02 x d1

Material	Alu Knet-leg.	Alu Guss-leg.	Stahl < 800 N/mm²	Stahl < 1200 N/mm²	Stahl < 1600 N/mm²	Stahl < 55 HRC	Stahl < 60 HRC	Stahl < 66 HRC	INOX < 800 N/mm²	INOX > 800 N/mm²	GG	GGG	hochw. Legierungen	Titan	NE-Metalle Cu-Leg.	Graphit & Faser-verbund	MMS	max.	ohne	AIR
40-5291			●	●	●				●	●	●	●	○	○			●	●	○	○

Schnittdaten siehe Seite / cutting data available on page – 201

● sehr gut geeignet / very suitable ○ bedingt geeignet / limited suitable

Ø d1 (e8) mm	40-5291	l2 mm	l1 mm	Ø d2 (h6) mm
	TA-B			
10		40	86	10
12		48	100	12

Ø d1 (e8) mm	40-5291	l2 mm	l1 mm	Ø d2 (h6) mm
	TA-B			
16		64	125	16
20		80	145	20

Bestellbeispiel / Order example: HB-Schaft / shank 40-5291-16-HB

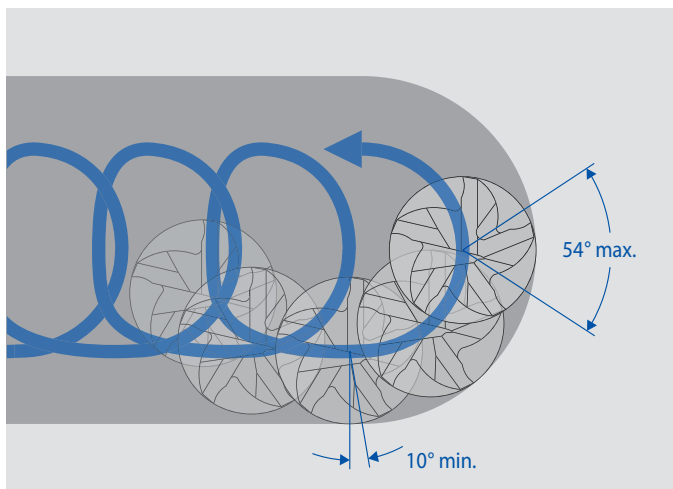

Trochoidal-Fräsen / Trochoidal milling

$h_m = \text{konstant}$ ($h_m = \text{Mittenspanndicke}$)
 $h_m = \text{constant}$ ($h_m = \text{mean chip thickness}$)

Überlagerung der Vorschubbewegung mit einer Kreisbewegung
Overlapping of feed motion with a circular movement

Besonders geeignet zum Trochoidal- und Hochgeschwindigkeits-Fräsen
Particularly suitable for trochoidal and highspeed milling

HAM 40-1561

Vollhartmetall-Schaftfräser solid carbide end mill

VHM	Z 6-8	45° rechts	Werk Norm
Typ N		DIN 6535 HA	
HSF	HSC	SHRINK FIT	
		DIN 6535 HB	

Konstruktions-Daten

- Spanwinkel 10° – 12°
- speziell zum Schlichten geeignet
- verstärkter Kern

Engineering data

- rake angle 10° – 12°
- especially for finishing machining
- reinforced web thickness

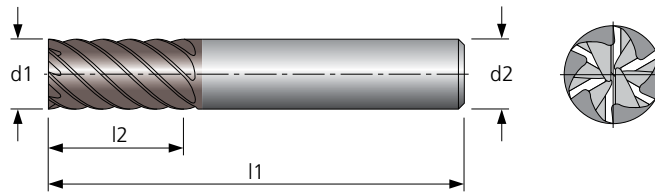

Eckenfase	d1	b
	= Ø 6	0,05
	≥ Ø 8	0,10
	≥ Ø 14	0,15
	≥ Ø 18	0,20

Material	Alu Knet- leg.	Alu Guss- leg.	Stahl < 800 N/mm²	Stahl < 1200 N/mm²	Stahl < 1600 N/mm²	Stahl < 55 HRC	Stahl < 60 HRC	Stahl < 66 HRC	INOX < 800 N/mm²	INOX > 800 N/mm²	GG	GGG	hochw. Legie- rungen	Titan	NE- Metalle Cu-Leg.	Graphit & Faser- verbund	MMS	max.	ohne	AIR
40-1561	○	○	●	●	●	○			●	●	●	●	●	●	○		●	●	○	○

Schnittdaten siehe Seite / cutting data available on page – 203

● sehr gut geeignet / very suitable ○ bedingt geeignet / limited suitable

Ø d1 (e8) mm	40-1561	l2 mm	l1 mm	Z	Ø d2 (h6) mm
	TA				
6		13	57	6	6
6		18	62	6	6
8		19	63	6	8
8		24	68	6	8
10		22	72	6	10
10		30	80	6	10
10		45	95	6	10
12		26	83	6	12
12		36	93	6	12
12		53	110	6	12
14		26	83	6	14
14		42	99	6	14
16		32	92	6	16

Ø d1 (e8) mm	40-1561	l2 mm	l1 mm	Z	Ø d2 (h6) mm
	TA				
16		48	108	6	16
16		63	123	8	16
16		80	135	8	16
18		32	92	8	18
18		54	114	8	18
20		38	104	8	20
20		60	125	8	20
20		75	141	8	20
20		100	166	8	20
20		125	191	8	20
25		40	110	8	25
25		75	150	8	25
32		40	110	8	32

Bestellbeispiel / Order example: HA-Schaft/shank 40-1561-16-48
HB-Schaft/shank 40-1561-16-48-HB

HAM 40-1571

Vollhartmetall-Schaftfräser solid carbide end mill

VHM	Z 6-8	34°/35°/36° re	Werk Norm
Typ N		DIN 6535 HA	
HSF	HSC	SHRINK FIT	
		DIN 6535 HB	

Konstruktions-Daten

- spezielle Geometrie mit ungleicher Drallsteigung
- hohe Laufruhe

Engineering data

- special geometry with unequal helix
- very smooth running

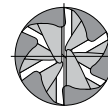
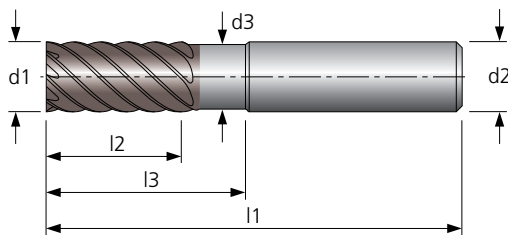

Eckenfase	d1	b
	= Ø 6	0,05
	≥ Ø 8	0,10
	≥ Ø 14	0,15
	≥ Ø 18	0,20

Material	Alu Knet-leg.	Alu Guss-leg.	Stahl < 800 N/mm²	Stahl < 1200 N/mm²	Stahl < 1600 N/mm²	Stahl < 55 HRC	Stahl < 60 HRC	Stahl < 66 HRC	INOX < 800 N/mm²	INOX > 800 N/mm²	GG	GGG	hochw. Legierungen	Titan	NE-Metalle Cu-Leg.	Graphit & Faser-verbund	MMS	max.	ohne	AIR
40-1571	○	○	●	●	●	○			●	●	●	●	●	●	○		●	●	○	○

Schnittdaten siehe Seite / cutting data available on page – 204

● sehr gut geeignet / very suitable ○ bedingt geeignet / limited suitable

Ø d1 (e8) mm	40-1571	l2 mm	l3 mm	Hals Ø d3 mm	l1 mm	Z	Ø d2 (h6) mm
	TA						
6		13	21	5,7	57	6	6
6		18	21	5,7	62	6	6
8		19	27	7,7	63	6	8
8		24	32	7,7	68	6	8
10		22	32	9,7	72	6	10
10		30	40	9,7	80	6	10
12		26	38	11,7	83	6	12
12		36	48	11,7	93	6	12
16		32	44	15,6	92	6	16
16		48	60	15,6	108	6	16
16		65	80	15,6	150	6	16
20		38	54	19,6	104	8	20

Ø d1 (e8) mm	40-1571	l2 mm	l3 mm	Hals Ø d3 mm	l1 mm	Z	Ø d2 (h6) mm
	TA						
20		60	76	19,6	125	8	20
20		80	95	19,6	150	8	20
20		110	125	19,6	180	8	20
25		40	54	24,5	110	8	25
25		75	89	24,5	150	8	25
25		110	125	24,5	180	8	25
25		150	165	24,5	230	8	25
32		85	100	31,5	155	8	32*
32		125	140	31,5	200	8	32*
32		155	—	—	230	8	32*

Bestellbeispiel / Order example: HA-Schaft/shank 40-1571-20-60
HB-Schaft/shank 40-1571-20-60-HB

* Schaftausführung DIN 6535 HA / Shank DIN 6535 HA

HAM 40-5200

Vollhartmetall-Schaftfräser
solid carbide end mill

W+F VHM Z 4-8 45° rechts Werk Norm
Typ H DIN 6535 HA
HSC SHRINK FIT
DIN 6535 HB

Konstruktions-Daten

- zum Hartfräsen bis 65 HRC
- Spanwinkel negativ
- verstärkter Kern

Engineering data

- for hard milling up to 65 HRC
- rake angle negative
- reinforced web thickness

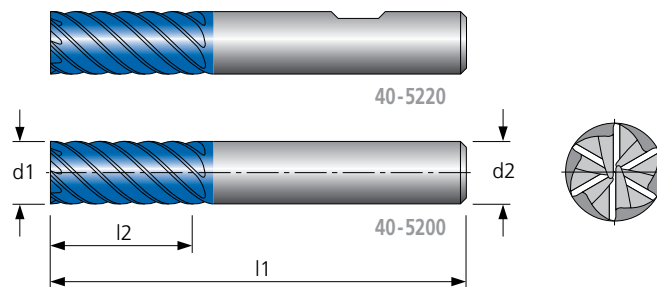

Eckenfase	d1	b
	≤ Ø 12	0,10
	> Ø 12	0,20

Material	Alu Knet-leg.	Alu Guss-leg.	Stahl < 800 N/mm²	Stahl < 1200 N/mm²	Stahl < 1600 N/mm²	Stahl < 55 HRC	Stahl < 60 HRC	Stahl < 66 HRC	INOX < 800 N/mm²	INOX > 800 N/mm²	GG	GGG	hochw. Legierungen	Titan	NE-Metalle Cu-Leg.	Graphit & Faser-verbund	MMS	max.	ohne	AIR	
40-5200 / 40-5220						●	●	●										●		●	●

Schnittdaten siehe Seite / cutting data available on page – 205

● sehr gut geeignet / very suitable ○ bedingt geeignet / limited suitable

Ø d1 (e8) mm	40-5200	40-5220	l2 mm	l1 mm	Z	Ø d2 (h6) mm
	DIN 6535 HA	DIN 6535 HB				
3			7	57	4	6
4			8	57	6	6
5			11	57	6	6
6			13	57	6	6
8			19	63	6	8
10			22	72	6	10
12			26	83	6	12

Ø d1 (e8) mm	40-5200	40-5220	l2 mm	l1 mm	Z	Ø d2 (h6) mm
	DIN 6535 HA	DIN 6535 HB				
14			26	83	6	14
16			32	92	6	16
18			32	92	8	18
20			38	104	8	20
25			40	110	8	25
32			40	110	8	32

Bestellbeispiel / Order example: HA-Schaft /shank 40-5200-14
HB-Schaft /shank 40-5220-14

HAM 40-5240

Vollhartmetall-Schaftfräser
solid carbide end mill

W+F VHM Z 6-8 45° rechts Werk Norm
Typ H DIN 6535 HA
HSC SHRINK FIT
DIN 6535 HB

Konstruktions-Daten

- zum Hartfräsen bis 65 HRC
- Spanwinkel negativ
- verstärkter Kern

Engineering data

- for hard milling up to 65 HRC
- rake angle negative
- reinforced web thickness

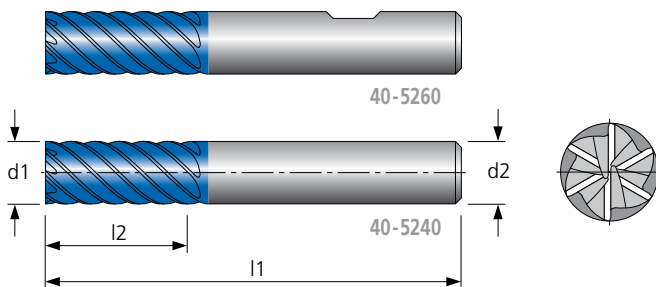

Eckenfase	d1	b
	≤ Ø 12	0,10
	> Ø 12	0,20

Material	Alu Knet-leg.	Alu Guss-leg.	Stahl < 800 N/mm²	Stahl < 1200 N/mm²	Stahl < 1600 N/mm²	Stahl < 55 HRC	Stahl < 60 HRC	Stahl < 66 HRC	INOX < 800 N/mm²	INOX > 800 N/mm²	GG	GGG	hochw. Legierungen	Titan	NE-Metalle Cu-Leg.	Graphit & Faser-verbund	MMS	max.	ohne	AIR
40-5240 / 40-5260						●	●	●									●		●	●

Schnittdaten siehe Seite / cutting data available on page – 205

● sehr gut geeignet / very suitable ○ bedingt geeignet / limited suitable

Ø d1 (e8) mm	40-5240	40-5260	l2 mm	l1 mm	Z	Ø d2 (h6) mm
	DIN 6535 HA	DIN 6535 HB				
	TA-X	TA-X				
6			18	62	6	6
8			24	68	6	8
10			30	80	6	10
12			36	93	6	12
14			42	99	6	14

Ø d1 (e8) mm	40-5240	40-5260	l2 mm	l1 mm	Z	Ø d2 (h6) mm
	DIN 6535 HA	DIN 6535 HB				
	TA-X	TA-X				
16			48	108	6	16
18			54	114	8	18
20			60	125	8	20
25			75	150	8	25

Bestellbeispiel / Order example: HA-Schaft /shank 40-5240-16
HB-Schaft /shank 40-5260-16

HAM 40-5280

Vollhartmetall-Schaftfräser
solid carbide end mill

W+F	VHM	Z 6-8	45° rechts	Werk Norm
Typ H	DIN 6535 HA	Eckradius	HSC	SHRINK FIT
	DIN 6535 HB			

Konstruktions-Daten

- zum Hartfräsen bis 65 HRC
- Schlichtfräser mit Eckenradius
- Spanwinkel negativ
- verstärkter Kern

Engineering data

- for hard milling up to 65 HRC
- finishing end mill with corner radius
- rake angle negative
- reinforced web thickness

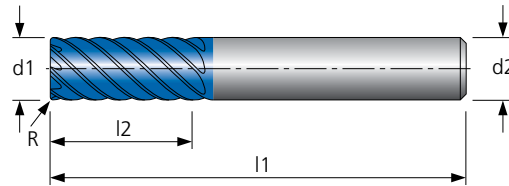

Material	Alu Knet- leg.	Alu Guss- leg.	Stahl < 800 N/mm ²	Stahl < 1200 N/mm ²	Stahl < 1600 N/mm ²	Stahl < 55 HRC	Stahl < 60 HRC	Stahl < 66 HRC	INOX < 800 N/mm ²	INOX > 800 N/mm ²	GG	GGG	hochw. Legie- rungen	Titan	NE- Metalle Cu-Leg.	Graphit & Faser- verbund	MMS	max.	ohne	AIR
40-5280						●	●	●									●		●	●

Schnittdaten siehe Seite / cutting data available on page – 206

● sehr gut geeignet / very suitable ○ bedingt geeignet / limited suitable

Ø d1/R (e8) mm	40-5280	l2 mm	l1 mm	Z	Ø d2 (h6) mm
	TA-X				
6/0,5		13	57	6	6
6/1		13	57	6	6
8/0,5		19	63	6	8
8/1		19	63	6	8
10/0,5		22	72	6	10
10/1		22	72	6	10
10/1,5		22	72	6	10
12/0,5		26	83	6	12

Ø d1/R (e8) mm	40-5280	l2 mm	l1 mm	Z	Ø d2 (h6) mm
	TA-X				
12/1		26	83	6	12
12/1,5		26	83	6	12
14/1		26	83	6	14
14/2		26	83	6	14
16/1		32	92	6	16
16/2		32	92	6	16
20/1		38	104	8	20
20/2		38	104	8	20

Bestellbeispiel / Order example: HA-Schaft / shank 40-5280-12/1
HB-Schaft / shank 40-5280-12/1-HB

HAM 40-5320

Vollhartmetall-Schaftfräser
solid carbide end mill

W+F	VHM	Z 6-8	45° rechts	Werk Norm
Typ H	DIN 6535 HA	Eckradius	HSC	SHRINK FIT
	DIN 6535 HB			

Konstruktions-Daten

- zum Hartfräsen bis 65 HRC
- Schlichtfräser mit Eckenradius
- Spanwinkel negativ
- verstärkter Kern

Engineering data

- for hard milling up to 65 HRC
- finishing end mill with corner radius
- rake angle negative
- reinforced web thickness

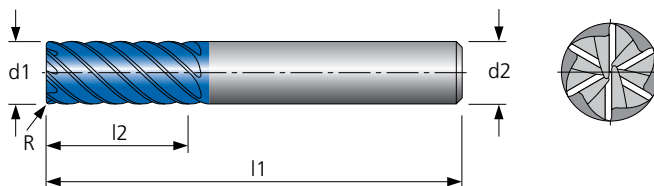

Material	Alu Knet- leg.	Alu Guss- leg.	Stahl < 800 N/mm ²	Stahl < 1200 N/mm ²	Stahl < 1600 N/mm ²	Stahl < 55 HRC	Stahl < 60 HRC	Stahl < 66 HRC	INOX < 800 N/mm ²	INOX > 800 N/mm ²	GG	GGG	hochw. Legie- rungen	Titan	NE- Metalle Cu-Leg.	Graphit & Faser- verbund	MMS	max.	ohne	AIR
40-5320						●	●	●									●		●	●

Schnittdaten siehe Seite / cutting data available on page – 206

● sehr gut geeignet / very suitable ○ bedingt geeignet / limited suitable

Ø d1/R (e8) mm	40-5320	l2 mm	l1 mm	Z	Ø d2 (h6) mm
	TA-X				
6/0,5		18	62	6	6
6/1		18	62	6	6
8/0,5		24	68	6	8
8/1		24	68	6	8
10/0,5		30	80	6	10
10/1		30	80	6	10
10/1,5		30	80	6	10
12/0,5		36	93	6	12
12/1		36	93	6	12
12/1,5		36	93	6	12

Ø d1/R (e8) mm	40-5320	l2 mm	l1 mm	Z	Ø d2 (h6) mm
	TA-X				
14/1		42	99	6	14
14/2		42	99	6	14
16/1		48	108	6	16
16/2		48	108	6	16
18/1		54	114	8	18
18/2		54	114	8	18
20/1		60	125	8	20
20/2		60	125	8	20
25/1		75	150	8	25
25/2		75	150	8	25

Bestellbeispiel / Order example: HA-Schaft /shank 40-5320-14/1
HB-Schaft /shank 40-5320-14/1-HB

Schruppfräser

roughing end mills



Vollhartmetall-Schruppfräser zur
Vorbearbeitung.

*Solid carbide roughing end mills especially
for premachining.*

HAM 40-5350

Vollhartmetall-Schruppfräser solid carbide roughing end mill

VHM Z 3 45° rechts Werk Norm
Typ W DIN 6535 HA
HSF HSC HPC SHRINK FIT
DIN 6535 HB

Konstruktions-Daten

- spezielle Geometrie mit ungleicher Drallsteigung, ohne Kordelverzahnung
- zum Schruppen mit extrem hohen Vorschüben
- hohes Zeitspanvolumen und max. Zustellung im Vollschnitt (bis 1,5 x D)
- hohe Laufruhe und vibrationsarme Bearbeitung
- Schneidbereich geometrisch gewuchtet

Engineering data

- special geometry with unequal helix, without knurling contour
- for roughing with extremely high feed
- high chipping volume (up to 1,5 x D)
- very smooth running and very little vibrations during machining
- cutting area geometrical balanced

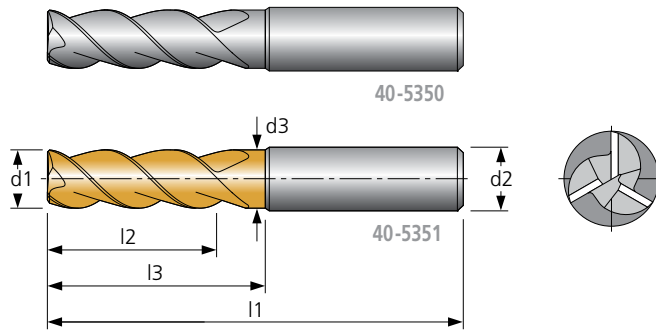

Eckenfase	d1	b
	≤ Ø 5 ≥ Ø 6	0,10 0,20

Material	Alu Knet-leg.	Alu Guss-leg.	Stahl < 800 N/mm²	Stahl < 1200 N/mm²	Stahl < 1600 N/mm²	Stahl < 55 HRC	Stahl < 60 HRC	Stahl < 66 HRC	INOX < 800 N/mm²	INOX > 800 N/mm²	GG	GGG	hochw. Legierungen	Titan	NE-Metalle Cu-Leg.	Graphit & Faser-verbund	MMS	max.	ohne	AIR
40-5350 / 40-5351	●	●													●		○	●	○	○

Schnittdaten siehe Seite / cutting data available on page – 207

● sehr gut geeignet / very suitable ○ bedingt geeignet / limited suitable

Ø d1 (h6) mm	40-5350	40-5351	l2 mm	l3 mm	Hals Ø d3 mm	l1 mm	Ø d2 (h6) mm
		TA-AL					
3			8	12	2,8	57	6
4			11	18	3,8	57	6
5			13	18	4,8	57	6
6			13	18	5,8	57	6
6			13	42	5,8	80	6
8			19	25	7,7	63	8
8			19	62	7,7	100	8
10			22	30	9,7	72	10

Ø d1 (h6) mm	40-5350	40-5351	l2 mm	l3 mm	Hals Ø d3 mm	l1 mm	Ø d2 (h6) mm
		TA-AL					
10			22	60	9,7	100	10
12			26	36	11,7	83	12
12			26	73	11,7	120	12
16			32	42	15,6	92	16
16			32	100	15,6	150	16
20			38	52	19,6	104	20
20			38	100	19,6	150	20

Bestellbeispiel / Order example: HA-Schaft /shank 40-5350-10-60
HB-Schaft /shank 40-5350-10-60-HB

Anwendungsbeispiel

Material: Al Mg Si1
Werkzeug: HPC- / HSC-Schruppfräser Ø 10,0 mm
Werkzeugaufnahme: Schrumpffutter

Schnittwerte:

$v_c = 565 \text{ m/min}$
 $f_z = 0,190 \text{ mm}$
 $v_f = 10000 \text{ mm/min}$
 $n = 18000 \text{ U/min}$
 $a_p = 10 \text{ mm}$
 $a_e = 10 \text{ mm}$

Application example

material: Al Mg Si1
tool: HPC / HSC roughing end mill Ø 10,0 mm
tool holder: shrink fit

cutting data:

$v_c = 565 \text{ m/min}$
 $f_z = 0,190 \text{ mm}$
 $v_f = 10000 \text{ mm/min}$
 $n = 18000 \text{ rev/min}$
 $a_p = 10 \text{ mm}$
 $a_e = 10 \text{ mm}$

HAM 40-1691

Vollhartmetall-Schruppfräser solid carbide roughing end mill

VHM Z 4 20°/23° re Werk Norm
Typ HR DIN 6535 HA
HPC SHRINK FIT
DIN 6535 HB

Konstruktions-Daten

- spezielle Geometrie mit ungleicher Drallsteigung und Teilung
- zum Schruppen mit extrem hohen Vorschüben
- hohes Zeitspanvolumen und max. Zustellung im Vollschnitt (bis 1,5 x D)
- hohe Laufruhe und vibrationsarme Bearbeitung

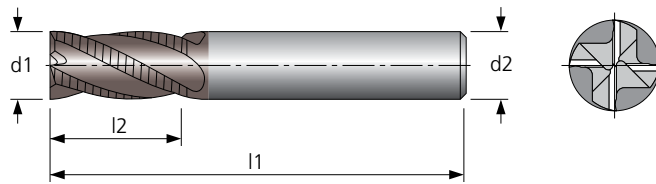

Engineering data

- special geometry with unequal helix and pitch
- for roughing with extremely high feed
- high chipping volume (up to 1,5 x D)
- very smooth running and very little vibrations during machining

Eckenfase	d1	b
	≥ Ø 6	0,02 x d1

Material	Alu Knet-leg.	Alu Guss-leg.	Stahl < 800 N/mm²	Stahl < 1200 N/mm²	Stahl < 1600 N/mm²	Stahl < 55 HRC	Stahl < 60 HRC	Stahl < 66 HRC	INOX < 800 N/mm²	INOX > 800 N/mm²	GG	GGG	hochw. Legierungen	Titan	NE-Metalle Cu-Leg.	Graphit & Faser-verbund	MMS	max.	ohne	AIR
40-1691			●	●	●				○	○	●	●	○				●	●		

Schnittdaten siehe Seite / cutting data available on page – 208

● sehr gut geeignet / very suitable ○ bedingt geeignet / limited suitable

Ø d1 (f10) mm	40-1691	l2 mm	l1 mm	Ø d2 (h6) mm
	TA-T			
6		13	57	6
8		19	63	8
10		22	72	10
12		26	83	12

Ø d1 (f10) mm	40-1691	l2 mm	l1 mm	Ø d2 (h6) mm
	TA-T			
14		26	83	14
16		32	92	16
20		38	104	20
25		38	110	25

Bestellbeispiel / Order example: HA-Schaft /shank 40-1691-14
HB-Schaft /shank 40-1691-14-HB

Um ein hohes Leistungsniveau zu gewährleisten, empfehlen wir, dieses Werkzeug bei HAM nachschleifen und nachbeschichten zu lassen.

To guarantee the high performance level we recommend to regrind and recoat the tools at HAM.

Anwendungsbeispiel

Material: GGG60
Werkzeug: HPC-Schruppfräser Ø 12,0 mm
Werkzeugaufnahme: Schrumpffutter

Schnittwerte:

$v_c = 140 \text{ m/min}$
 $f_z = 0,060 \text{ mm}$
 $v_f = 891 \text{ mm/min}$
 $n = 3715 \text{ U/min}$
 $a_p = 12 \text{ mm}$
 $a_e = 12 \text{ mm}$

Application example

material: GGG60
tool: HPC roughing end mill Ø 12,0 mm
tool holder: shrink fit

cutting data:

$v_c = 140 \text{ m/min}$
 $f_z = 0,060 \text{ mm}$
 $v_f = 891 \text{ mm/min}$
 $n = 3715 \text{ rev/min}$
 $a_p = 12 \text{ mm}$
 $a_e = 12 \text{ mm}$

HAM 40-1681

Vollhartmetall-Schruppfräser solid carbide roughing end mill

VHM
Z 3-6
20° rechts
Werk Norm

Typ HR
DIN 6535 HA

HPC
SHRINK FIT

DIN 6535 HB

Konstruktions-Daten

- zentrumsschneidend
- kordelverzahnt
- hohe Laufruhe

Engineering data

- centre cutting
- flute with knurling contour
- very smooth running

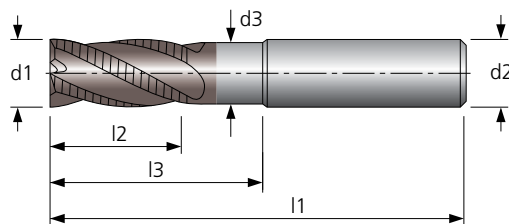

Eckenfase	d1	b
	≤ Ø 8	0,05
	≥ Ø 9	0,10

Material	Alu Knet-leg.	Alu Guss-leg.	Stahl < 800 N/mm²	Stahl < 1200 N/mm²	Stahl < 1600 N/mm²	Stahl < 55 HRC	Stahl < 60 HRC	Stahl < 66 HRC	INOX < 800 N/mm²	INOX > 800 N/mm²	GG	GGG	hochw. Legierungen	Titan	NE-Metalle Cu-Leg.	Graphit & Faser-verbund	MMS	max.	ohne	AIR
40-1681			●	●	●				○	○	●	●	○				●	●		

Schnittdaten siehe Seite / cutting data available on page – 209

● sehr gut geeignet / very suitable ○ bedingt geeignet / limited suitable

Ø d1 (f10) mm	40-1681	l2 mm	l3 mm	Hals Ø d3 mm	l1 mm	Z	Ø d2 (h6) mm
	TA-T						
4		8	—	—	57	3	6
5		10	—	—	57	3	6
6		13	—	—	57	3	6
6		13	21	5,7	57	3	6
6		18	—	—	62	3	6
7		16	—	—	63	3	8
8		19	—	—	63	3	8
8		19	27	7,7	63	3	8
8		24	—	—	68	3	8
9		19	—	—	72	3	10
10		22	—	—	72	4	10
10		22	32	9,7	72	4	10
10		30	—	—	80	4	10
12		26	—	—	83	4	12
12		26	38	11,7	83	4	12
12		36	—	—	93	4	12

Ø d1 (f10) mm	40-1681	l2 mm	l3 mm	Hals Ø d3 mm	l1 mm	Z	Ø d2 (h6) mm
	TA-T						
14		26	—	—	83	4	14
14		26	38	13,6	83	4	14
14		42	—	—	99	4	14
16		32	—	—	92	4	16
16		32	44	15,6	92	4	16
16		48	—	—	108	4	16
18		32	—	—	92	4	18
18		32	44	17,6	92	4	18
18		54	—	—	114	4	18
20		38	—	—	104	4	20
20		38	54	19,6	104	4	20
20		60	—	—	125	4	20
25		38	—	—	110	6	25
25		38	54	24,5	110	6	25
25		75	—	—	150	6	25

Bestellbeispiel / Order example: HA-Schaft/shank 40-1681-14-26-38
HB-Schaft/shank 40-1681-14-26-38-HB

HAM 40-1600

Vollhartmetall-Konturenfräser (upcut)
solid carbide router (upcut)

VHM Z 8-12 22°-25°re Werk Norm
Typ W HA
G-Point

Konstruktions-Daten

- rechtsspiralig, rechtsschneidend (upcut)
- spezielle Diamantverzahnung

Engineering data

- right hand fluted, right hand cutting (upcut)
- special diamondprofiled teeth

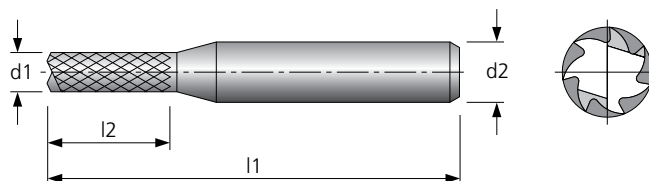

Auf Anfrage Diamantbeschichtung für Graphitbearbeitung
Diamond coating for machining of graphite on request

Material	Alu Knet-leg.	Alu Guss-leg.	Stahl < 800 N/mm²	Stahl < 1200 N/mm²	Stahl < 1600 N/mm²	Stahl < 55 HRC	Stahl < 60 HRC	Stahl < 66 HRC	INOX < 800 N/mm²	INOX > 800 N/mm²	GG	GGG	hochw. Legierungen	Titan	NE-Metalle Cu-Leg.	Graphit & Faser-verbund	MMS	max.	ohne	AIR	
40-1600																●				●	○

Schnittdaten siehe Seite / cutting data available on page – 210

● sehr gut geeignet / very suitable ○ bedingt geeignet / limited suitable

Ø d1 (0,02/-0,02) mm	40-1600	l2 mm	l1 mm	Z	Ø d2 (h6) mm
4		15	40	8	4
5		20	50	10	5
6		20	50	10	6
6,35		25	60	10	6,35
8		25	60	10	8
9,52		25	60	10	9,52

Ø d1 (0,02/-0,02) mm	40-1600	l2 mm	l1 mm	Z	Ø d2 (h6) mm
10		30	90	10	10
12		36	120	10	12
12,7		40	120	10	12,7
14		36	92	10	14
16		36	92	12	16
20		45	104	12	20

Bestellbeispiel / Order example: 40-1600-10-30

Weitere Geometrien und Stirnanschliffe auf Anfrage
Further geometries and point geometries on request

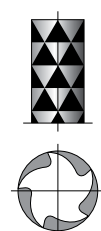

A-Spitze
Gerade Stirn ohne Anschlag
A-Point
straight end no end cut

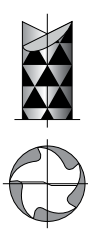

B-Spitze
Fischschwanz Anschlag
B-Point
fishtail end cut

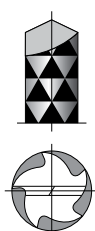

D-Spitze
Bohrspitze
D-Point
drill point

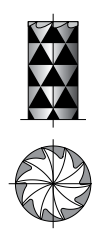

E-Spitze
Gerade 8 – 12 Stirnschneiden
E-Point
straight end 8 – 12 cutting edges

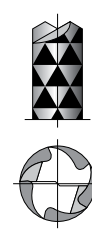

G-Spitze
Standard Anschlag
G-Point
standard end cut

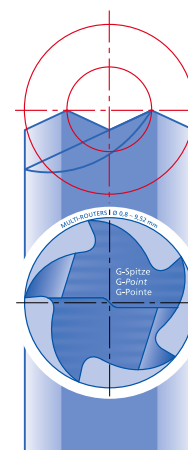

Präzisionswerkzeuge

precision tools



HAM – Ihr kompetenter Partner in der Präzisionswerkzeug-Technologie.

HAM – Your competent partner in the precision tool technology.

Torusfräser

toric end mills



Vollhartmetall-Torusfräser in verschiedenen Ausführungen.

Solid carbide toric end mills in different types.

HAM 40-5400

Vollhartmetall-Torusfräser solid carbide toric end mill

W+F
 VHM
 Z 2
 30° rechts
 Werk Norm
 Typ W
 HA
 HSF
 Eckradius
 HSC
 SHRINK FIT
 HB

Konstruktions-Daten

- spezielle Ausspitzung
- bis Ø 4 mm verstärkter Schaftübergang
- zentrumsschneidend
- Radiusform-Toleranz 0,02

Engineering data

- special web thinning
- up to Ø 4 mm reinforced shank
- centre cutting
- radius form tolerance 0,02

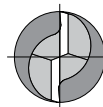
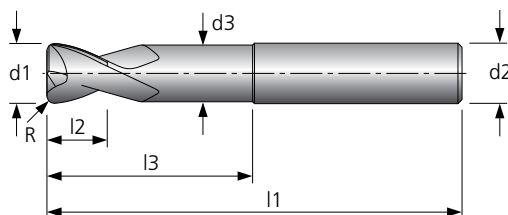

Material	Alu Knet-leg.	Alu Guss-leg.	Stahl < 800 N/mm²	Stahl < 1200 N/mm²	Stahl < 1600 N/mm²	Stahl < 55 HRC	Stahl < 60 HRC	Stahl < 66 HRC	INOX < 800 N/mm²	INOX > 800 N/mm²	GG	GGG	hochw. Legierungen	Titan	NE-Metalle Cu-Leg.	Graphit & Faser-verbund	MMS	max.	ohne	AIR
40-5400	●	●													●	○	●	●	○	○

Schnittdaten siehe Seite / cutting data available on page – 211

● sehr gut geeignet / very suitable ○ bedingt geeignet / limited suitable

Ø d1/R (0/-0,01) mm	40-5400	l2 mm	l3 mm	Hals Ø d3 mm	l1 mm	Ø d2 (h6) mm
1/0,1		2	15	0,9	60	4
2/0,2		3	20	1,8	60	4
3/0,3		5	20	2,7	60	4
4/0,5		5	20	3,7	60	4
5/0,5		6	20	4,6	60	6
6/0,5		7	25	5,5	65	6
6/1		7	25	5,5	65	6

Ø d1/R (0/-0,01) mm	40-5400	l2 mm	l3 mm	Hals Ø d3 mm	l1 mm	Ø d2 (h6) mm
8/0,5		9	30	7,4	70	8
8/1		9	30	7,4	70	8
10/0,5		11	40	9,2	85	10
10/1		11	40	9,2	85	10
12/0,5		12	45	11	93	12
12/1		12	45	11	93	12
16/0,5		16	55	15	110	16
16/2		16	55	15	110	16

Bestellbeispiel / Order example: HA-Schaft/shank 40-5400-8/0,5
HB-Schaft/shank 40-5400-8/0,5-HB

HAM 40-5460

Vollhartmetall-Torusfräser solid carbide toric end mill

W+F VHM Z 2 30° rechts Werk Norm

Konstruktions-Daten

- für dünnwandige Konturen in Aluminium und Kunststoff
- spezielle Ausspitzung
- zentrumsschneidend
- Radiusform-Toleranz 0,01

Engineering data

- for thin-walled contours of aluminium and synthetic material
- special web thinning
- centre cutting
- radius form tolerance 0,01

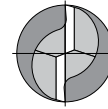
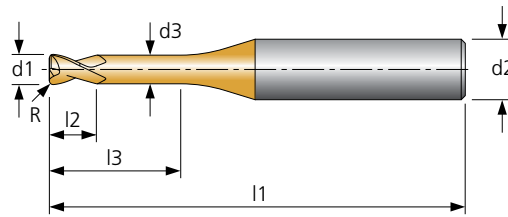

Typ W 30° rechts DIN 6535 HA

HSF Eckradius HSC SHRINK FIT

Material	Alu Knet-leg.	Alu Guss-leg.	Stahl < 800 N/mm²	Stahl < 1200 N/mm²	Stahl < 1600 N/mm²	Stahl < 55 HRC	Stahl < 60 HRC	Stahl < 66 HRC	INOX < 800 N/mm²	INOX > 800 N/mm²	GG	GGG	hochw. Legierungen	Titan	NE-Metalle Cu-Leg.	Graphit & Faser-verbund	MMS	max.	ohne	AIR
40-5460	●	●							○	○				○	●	○	●	●	○	○

Schnittdaten siehe Seite / cutting data available on page – 212

● sehr gut geeignet / very suitable ○ bedingt geeignet / limited suitable

Ø d1/R (0/-0,01) mm	40-5460	l2 mm	l3 mm	Hals Ø d3 mm	l1 mm	Ø d2 (h6) mm	Ø d1/R (0/-0,01) mm	40-5460	l2 mm	l3 mm	Hals Ø d3 mm	l1 mm	Ø d2 (h6) mm
	TA-AL							TA-AL					
0,2/0,05		0,3	0,5	0,18	55	4	2,0/0,2		2,5	24	1,92	75	4
0,2/0,05		0,3	1	0,18	55	4	2,0/0,2		2,5	30	1,92	75	4
0,2/0,05		0,3	1,5	0,18	55	4	2,0/0,5		2,5	6	1,92	65	4
0,3/0,05		0,45	1	0,28	55	4	2,0/0,5		2,5	10	1,92	65	4
0,3/0,05		0,45	2	0,28	55	4	2,0/0,5		2,5	14	1,92	65	4
0,3/0,05		0,45	3	0,28	55	4	2,0/0,5		2,5	18	1,92	65	4
0,4/0,1		0,6	2	0,37	55	4	2,0/0,5		2,5	24	1,92	75	4
0,4/0,1		0,6	3	0,37	55	4	2,0/0,5		2,5	30	1,92	75	4
0,4/0,1		0,6	4	0,37	55	4	2,5/0,25		3,5	10	2,4	65	4
0,5/0,1		0,7	3	0,47	55	4	2,5/0,25		3,5	20	2,4	65	4
0,5/0,1		0,7	5	0,47	55	4	2,5/0,25		3,5	30	2,4	75	4
0,5/0,1		0,7	8	0,47	55	4	3,0/0,2		5	6	2,9	65	4
0,6/0,1		0,9	3	0,57	55	4	3,0/0,2		5	10	2,9	65	4
0,6/0,1		0,9	5	0,57	55	4	3,0/0,2		5	14	2,9	65	4
0,6/0,1		0,9	8	0,57	55	4	3,0/0,2		5	18	2,9	65	4
0,8/0,2		1,1	4	0,76	55	4	3,0/0,2		5	24	2,9	75	4
0,8/0,2		1,1	6	0,76	55	4	3,0/0,2		5	30	2,9	75	4
0,8/0,2		1,1	8	0,76	55	4	3,0/0,5		5	6	2,9	65	4
0,8/0,2		1,1	10	0,76	55	4	3,0/0,5		5	10	2,9	65	4
1,0/0,2		1,5	6	0,95	55	4	3,0/0,5		5	14	2,9	65	4
1,0/0,2		1,5	10	0,95	55	4	3,0/0,5		5	18	2,9	65	4
1,0/0,2		1,5	14	0,95	55	4	3,0/0,5		5	24	2,9	75	4
1,0/0,2		1,5	18	0,95	55	4	3,0/0,5		5	30	2,9	75	4
1,0/0,2		1,5	24	0,95	60	4	4,0/0,5		6	10	3,9	65	6
1,2/0,2		1,6	6	1,15	55	4	4,0/0,5		6	14	3,9	65	6
1,2/0,2		1,6	10	1,15	55	4	4,0/0,5		6	18	3,9	65	6
1,2/0,2		1,6	14	1,15	55	4	4,0/0,5		6	24	3,9	75	6
1,2/0,2		1,6	18	1,15	55	4	4,0/0,5		6	30	3,9	75	6
1,2/0,2		1,6	24	1,15	60	4	5,0/0,5		7,5	10	4,9	65	6
1,5/0,2		2	6	1,44	55	4	5,0/0,5		7,5	20	4,9	65	6
1,5/0,2		2	10	1,44	55	4	5,0/0,5		7,5	30	4,9	75	6
1,5/0,2		2	14	1,44	55	4	5,0/0,5		7,5	40	4,9	90	6
1,5/0,2		2	18	1,44	55	4	6,0/0,5		10	12	5,9	65	6
1,5/0,2		2	24	1,44	60	4	6,0/0,5		10	20	5,9	65	6
2,0/0,2		2,5	6	1,92	65	4	6,0/0,5		10	30	5,9	75	6
2,0/0,2		2,5	10	1,92	65	4	6,0/0,5		10	40	5,9	90	6
2,0/0,2		2,5	14	1,92	65	4	6,0/0,5		10	50	5,9	90	6
2,0/0,2		2,5	18	1,92	65	4	6,0/0,5		10	50	5,9	90	6

HAM 40-5480

Vollhartmetall-Torusfräser solid carbide toric end mill

W+F
VHM
Z 2
35° rechts
Werk Norm

Typ W
35° rechts
DIN 6535 HA

Eckradius
HSC
SHRINK FIT

Konstruktions-Daten

- zentrumsschneidend
- abgesetzter Hals
- Diamantbeschichtung für abrasive Werkstoffe
- Radiusform-Toleranz 0,01

Engineering data

- centre cutting
- reduced neck
- diamond coating for abrasive materials
- radius form tolerance 0,01

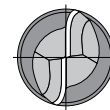
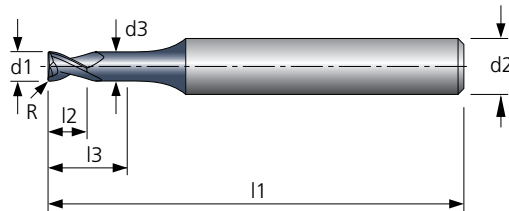

Material	Alu Knet-leg.	Alu Guss-leg.	Stahl < 800 N/mm²	Stahl < 1200 N/mm²	Stahl < 1600 N/mm²	Stahl < 55 HRC	Stahl < 60 HRC	Stahl < 66 HRC	INOX < 800 N/mm²	INOX > 800 N/mm²	GG	GGG	hochw. Legierungen	Titan	NE-Metalle Cu-Leg.	Graphit & Faserverbund	MMS	max.	ohne	AIR
40-5480																	●	○	●	

Schnittdaten siehe Seite / cutting data available on page – 213

● sehr gut geeignet / very suitable ○ bedingt geeignet / limited suitable

Ø d1/R (0/-0,01) mm	40-5480						Ø d1/R (0/-0,01) mm	40-5480					
	Diamant	l2 mm	l3 mm	Hals Ø d3 mm	l1 mm	Ø d2 (h6) mm		Diamant	l2 mm	l3 mm	Hals Ø d3 mm	l1 mm	Ø d2 (h6) mm
0,2/0,05		0,3	0,5	0,18	55	4	2,0/0,2		2,5	18	1,92	65	4
0,2/0,05		0,3	1	0,18	55	4	2,0/0,2		2,5	24	1,92	75	4
0,2/0,05		0,3	1,5	0,18	55	4	2,0/0,2		2,5	30	1,92	75	4
0,3/0,05		0,45	1	0,28	55	4	2,0/0,5		2,5	6	1,92	65	4
0,3/0,05		0,45	2	0,28	55	4	2,0/0,5		2,5	10	1,92	65	4
0,3/0,05		0,45	3	0,28	55	4	2,0/0,5		2,5	14	1,92	65	4
0,4/0,1		0,6	2	0,37	55	4	2,0/0,5		2,5	18	1,92	65	4
0,4/0,1		0,6	3	0,37	55	4	2,0/0,5		2,5	24	1,92	75	4
0,4/0,1		0,6	4	0,37	55	4	2,0/0,5		2,5	30	1,92	75	4
0,5/0,1		0,7	3	0,47	55	4	2,5/0,25		3,5	10	2,4	65	4
0,5/0,1		0,7	5	0,47	55	4	2,5/0,25		3,5	20	2,4	65	4
0,5/0,1		0,7	8	0,47	55	4	2,5/0,25		3,5	30	2,4	75	4
0,6/0,1		0,9	3	0,57	55	4	3,0/0,2		5	6	2,9	65	4
0,6/0,1		0,9	5	0,57	55	4	3,0/0,2		5	10	2,9	65	4
0,6/0,1		0,9	8	0,57	55	4	3,0/0,2		5	14	2,9	65	4
0,8/0,2		1,1	4	0,76	55	4	3,0/0,2		5	18	2,9	65	4
0,8/0,2		1,1	6	0,76	55	4	3,0/0,2		5	24	2,9	75	4
0,8/0,2		1,1	8	0,76	55	4	3,0/0,2		5	30	2,9	75	4
0,8/0,2		1,1	10	0,76	55	4	3,0/0,5		5	6	2,9	65	4
1,0/0,2		1,5	6	0,95	55	4	3,0/0,5		5	10	2,9	65	4
1,0/0,2		1,5	10	0,95	55	4	3,0/0,5		5	14	2,9	65	4
1,0/0,2		1,5	14	0,95	55	4	3,0/0,5		5	18	2,9	65	4
1,0/0,2		1,5	18	0,95	55	4	3,0/0,5		5	24	2,9	75	4
1,0/0,2		1,5	24	0,95	60	4	3,0/0,5		5	30	2,9	75	4
1,2/0,2		1,6	6	1,15	55	4	4,0/0,5		6	10	3,9	65	6
1,2/0,2		1,6	10	1,15	55	4	4,0/0,5		6	14	3,9	65	6
1,2/0,2		1,6	14	1,15	55	4	4,0/0,5		6	18	3,9	65	6
1,2/0,2		1,6	18	1,15	55	4	4,0/0,5		6	24	3,9	75	6
1,2/0,2		1,6	24	1,15	60	4	4,0/0,5		6	30	3,9	75	6
1,5/0,2		2	6	1,44	55	4	5,0/0,5		7,5	10	4,9	65	6
1,5/0,2		2	10	1,44	55	4	5,0/0,5		7,5	20	4,9	65	6
1,5/0,2		2	14	1,44	55	4	5,0/0,5		7,5	30	4,9	75	6
1,5/0,2		2	18	1,44	55	4	5,0/0,5		7,5	40	4,9	90	6
1,5/0,2		2	24	1,44	60	4	6,0/0,5		10	12	5,9	65	6
2,0/0,2		2,5	6	1,92	65	4	6,0/0,5		10	20	5,9	65	6
2,0/0,2		2,5	10	1,92	65	4	6,0/0,5		10	30	5,9	75	6
2,0/0,2		2,5	14	1,92	65	4	6,0/0,5		10	40	5,9	90	6
2,0/0,2		2,5	18	1,92	65	4	6,0/0,5		10	50	5,9	90	6

Bestellbeispiel / Order example: 40-5480-2,0/0,2-18

HAM 40-6120

Vollhartmetall-Torusfräser solid carbide toric end mill

W+F VHM Z 2 30° rechts Werk Norm
Typ H HA
HSF Eckradius HSC SHRINK FIT

Konstruktions-Daten

- konischer Hals 0,9°
- langer Hals zum Rippenfräsen
- extrem verstärkter Kern
- Radiusform-Toleranz 0,01

Engineering data

- conical neck 0,9°
- long neck for rib milling
- strongly reinforced web thickness
- radius form tolerance 0,01

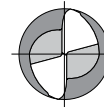
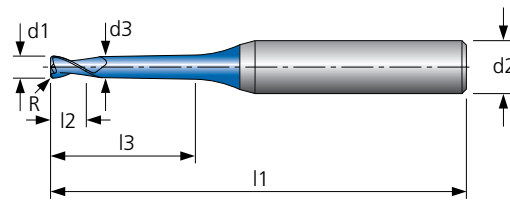

Material	Alu Knet-leg.	Alu Guss-leg.	Stahl < 800 N/mm²	Stahl < 1200 N/mm²	Stahl < 1600 N/mm²	Stahl < 55 HRC	Stahl < 60 HRC	Stahl < 66 HRC	INOX < 800 N/mm²	INOX > 800 N/mm²	GG	GGG	hochw. Legierungen	Titan	NE-Metalle Cu-Leg.	Graphit & Faser-verbund	MMS	max.	ohne	AIR
40-6120			○	●	●	●	●	○	○	○	●	●					●		●	●

Schnittdaten siehe Seite / cutting data available on page – 214

● sehr gut geeignet / very suitable ○ bedingt geeignet / limited suitable

Ø d1/R (0/-0,01) mm	40-6120 TA-X	l2 mm	l3 mm	Hals Ø d3 mm	l1 mm	Ø d2 (h6) mm	Effektive Bearbeitungstiefe abhängig vom Konturwinkel (β) des Werkstückes. Effective machining depth depending on inclined angle (β) of workpiece.					
							0,5°	1°	1,5°	2°	2,5°	3°
							0,2/0,05	0,3	0,5	0,18	45	4
0,2/0,05	0,3	1	0,18	45	4	1,52	1,79	2,02	2,24	2,45	2,65	
0,2/0,05	0,3	1,5	0,18	45	4	1,93	2,3	2,59	2,84	3,07	3,3	
0,3/0,05	0,45	1	0,28	45	4	1,58	1,83	2,06	2,27	2,48	2,68	
0,3/0,05	0,45	2	0,28	45	4	2,42	2,86	3,18	3,46	3,71	3,95	
0,3/0,05	0,45	3	0,28	45	4	2,72	3,88	4,29	4,62	4,91	5,18	
0,4/0,1	0,6	2	0,37	45	4	2,6	2,96	3,25	3,51	3,76	3,99	
0,4/0,1	0,6	3	0,37	45	4	3,44	3,98	4,35	4,67	4,95	5,22	
0,4/0,1	0,6	4	0,37	45	4	3,82	5	5,44	5,8	6,12	6,41	
0,5/0,1	0,7	2	0,45	45	4	2,81	3,11	3,38	3,62	3,85	4,07	
0,5/0,1	0,7	4	0,45	45	4	4,58	5,15	5,55	5,89	6,2	6,48	
0,5/0,1	0,7	6	0,45	45	4	5,71	7,18	7,7	8,12	8,48	8,81	
0,5/0,1	0,7	8	0,45	45	4	5,71	9,22	9,84	10,32	10,73	11,1	
0,6/0,1	0,9	2	0,55	45	4	2,85	3,14	3,4	3,64	3,87	4,09	
0,6/0,1	0,9	4	0,55	45	4	4,64	5,18	5,57	5,91	6,21	6,49	
0,6/0,1	0,9	6	0,55	45	4	6,26	7,21	7,72	8,13	8,49	8,82	
0,6/0,1	0,9	8	0,55	45	4	6,16	9,24	9,86	10,33	10,74	11,11	
0,6/0,1	0,9	10	0,55	45	4	6,16	11,28	11,98	12,51	12,96	13,36	
0,7/0,1	1	2	0,65	45	4	2,89	3,17	3,43	3,67	3,9	4,11	
0,7/0,1	1	4	0,65	45	4	4,7	5,21	5,6	5,93	6,23	6,51	
0,7/0,1	1	6	0,65	45	4	6,39	7,24	7,74	8,15	8,51	8,84	
0,7/0,1	1	8	0,65	45	4	6,61	9,27	9,87	10,35	10,75	11,12	
0,7/0,1	1	10	0,65	45	4	6,61	11,3	12	12,52	12,97	13,37	
0,8/0,2	1,2	4	0,75	45	4	4,73	5,22	5,6	5,93	6,22	6,5	
0,8/0,2	1,2	6	0,75	45	4	6,46	7,25	7,75	8,15	8,5	8,83	
0,8/0,2	1,2	8	0,75	45	4	6,93	9,29	9,88	10,34	10,75	11,11	
0,8/0,2	1,2	10	0,75	45	4	6,93	11,32	12	12,52	12,97	13,36	
0,8/0,2	1,2	12	0,75	45	4	6,93	13,35	14,11	14,69	15,17	15,59	
0,9/0,2	1,35	6	0,85	45	4	6,53	7,28	7,77	8,16	8,52	8,84	
0,9/0,2	1,35	8	0,85	45	4	7,38	9,31	9,9	10,36	10,76	11,12	
0,9/0,2	1,35	10	0,85	45	4	7,38	11,34	12,02	12,54	12,98	13,37	
0,9/0,2	1,35	15	0,85	50	4	7,38	16,42	17,29	17,92	18,45	18,92	
1,0/0,2	1,5	6	0,95	45	4	6,6	7,31	7,79	8,18	8,53	8,85	
1,0/0,2	1,5	8	0,95	45	4	7,83	9,34	9,92	10,37	10,77	11,13	
1,0/0,2	1,5	10	0,95	45	4	7,83	11,37	12,03	12,55	12,99	13,38	
1,0/0,2	1,5	12	0,95	45	4	7,83	13,4	14,15	14,71	15,19	15,61	
1,0/0,2	1,5	14	0,95	50	4	7,83	15,43	16,25	16,86	17,37	17,82	
1,0/0,2	1,5	16	0,95	50	4	7,83	17,45	18,35	19	19,55	20,02	

Bestellbeispiel / Order example: 40-6120-0,2/0,05-0,5

Ø d1/R (0/-0,01) mm	40-6120	l2 mm	l3 mm	Hals Ø d3 mm	l1 mm	Ø d2 (h6) mm	Effektive Bearbeitungstiefe abhängig vom Konturwinkel (β) des Werkstückes. Effective machining depth depending on inclined angle (β) of workpiece.					
							0,5°	1°	1,5°	2°	2,5°	3°
	TA-X	mm	mm	mm	mm	mm	mm	mm	mm	mm	mm	mm
1,2/0,2		1,8	6	1,15	45	4	6,71	7,36	7,83	8,21	8,56	8,88
1,2/0,2		1,8	8	1,15	45	4	8,42	9,39	9,95	10,4	10,8	11,16
1,2/0,2		1,8	10	1,15	45	4	8,73	11,42	12,07	12,58	13,01	13,41
1,2/0,2		1,8	12	1,15	45	4	8,73	13,45	14,18	14,74	15,21	15,63
1,4/0,2		2,1	6	1,35	45	4	6,8	7,42	7,86	8,25	8,59	8,9
1,4/0,2		2,1	8	1,35	45	4	8,57	9,44	9,99	10,43	10,82	11,18
1,4/0,2		2,1	10	1,35	45	4	9,63	11,47	12,1	12,6	13,04	13,43
1,4/0,2		2,1	12	1,35	45	4	9,63	13,5	14,21	14,76	15,23	15,65
1,4/0,2		2,1	14	1,35	50	4	9,63	15,52	16,31	16,91	17,41	17,86
1,4/0,2		2,1	16	1,35	50	4	9,63	17,55	18,41	19,05	19,58	20,05
1,5/0,2		2,3	6	1,45	45	4	6,85	7,44	7,88	8,26	8,6	8,92
1,5/0,2		2,3	8	1,45	45	4	8,63	9,47	10,01	10,45	10,84	11,19
1,5/0,2		2,3	10	1,45	45	4	10,22	11,49	12,12	12,62	13,05	13,44
1,5/0,2		2,3	12	1,45	45	4	10,08	13,52	14,23	14,77	15,24	15,66
1,5/0,2		2,3	14	1,45	50	4	10,08	15,54	16,33	16,92	17,42	17,87
1,5/0,2		2,3	16	1,45	50	4	10,08	17,57	18,42	19,06	19,59	20,06
1,5/0,2		2,3	18	1,45	55	4	10,08	19,59	20,51	21,19	21,75	22,24
1,5/0,2		2,3	20	1,45	55	4	10,08	21,62	22,6	23,31	23,9	—
1,6/0,2		2,4	6	1,55	45	4	6,89	7,46	7,9	8,28	8,62	8,93
1,6/0,2		2,4	8	1,55	45	4	8,69	9,49	10,02	10,46	10,85	11,2
1,6/0,2		2,4	10	1,55	45	4	10,37	11,52	12,14	12,63	13,06	13,45
1,6/0,2		2,4	12	1,55	45	4	10,53	13,54	14,24	14,79	15,25	15,67
1,6/0,2		2,4	14	1,55	50	4	10,53	15,57	16,34	16,93	17,43	17,88
1,6/0,2		2,4	16	1,55	50	4	10,53	17,59	18,44	19,07	19,6	20,07
1,6/0,2		2,4	18	1,55	55	4	10,53	19,62	20,53	21,2	21,76	22,25
1,6/0,2		2,4	20	1,55	55	4	10,53	21,64	22,62	23,32	23,91	—
1,8/0,2		2,7	6	1,75	45	4	6,96	7,51	7,94	8,31	8,64	8,95
1,8/0,2		2,7	8	1,75	45	4	8,78	9,54	10,06	10,49	10,87	11,22
1,8/0,2		2,7	10	1,75	45	4	10,54	11,56	12,17	12,66	13,08	13,47
1,8/0,2		2,7	12	1,75	45	4	11,43	13,59	14,27	14,81	15,27	15,69
1,8/0,2		2,7	14	1,75	50	4	11,43	15,61	16,37	16,96	17,45	17,89
1,8/0,2		2,7	16	1,75	50	4	11,43	17,63	18,46	19,09	19,62	20,08
1,8/0,2		2,7	18	1,75	55	4	11,43	19,66	20,55	21,22	21,78	—
1,8/0,2		2,7	20	1,75	55	4	11,43	21,68	22,64	23,34	23,93	—
2,0/0,2		3	6	1,95	45	4	7,03	7,56	7,98	8,34	8,67	8,98
2,0/0,2		3	8	1,95	45	4	8,87	9,58	10,09	10,52	10,9	11,24
2,0/0,2		3	10	1,95	45	4	10,66	11,61	12,2	12,68	13,1	13,49
2,0/0,2		3	12	1,95	45	4	12,32	13,63	14,3	14,84	15,29	15,71
2,0/0,2		3	14	1,95	50	4	12,33	15,65	16,4	16,98	17,47	17,91
2,0/0,2		3	16	1,95	50	4	12,33	17,68	18,49	19,11	19,64	—
2,0/0,2		3	18	1,95	55	4	12,33	19,7	20,58	21,24	21,79	—
2,0/0,2		3	20	1,95	55	4	12,33	21,72	22,67	23,36	—	—
2,0/0,2		3	25	1,95	60	4	12,33	26,78	27,87	28,65	—	—
2,0/0,2		3	30	1,95	70	4	12,33	31,83	33,05	—	—	—
2,0/0,5		3	6	1,95	45	4	7	7,52	7,93	8,29	8,61	8,92
2,0/0,5		3	8	1,95	45	4	8,83	9,54	10,05	10,47	10,85	11,19
2,0/0,5		3	10	1,95	45	4	10,62	11,57	12,16	12,64	13,06	13,44
2,0/0,5		3	12	1,95	45	4	12,12	13,59	14,26	14,79	15,25	15,66
2,0/0,5		3	14	1,95	50	4	11,95	15,62	16,36	16,94	17,43	17,87
2,0/0,5		3	16	1,95	50	4	11,95	17,64	18,46	19,08	19,6	—
2,0/0,5		3	18	1,95	55	4	11,95	19,67	20,55	21,21	21,76	—
2,0/0,5		3	20	1,95	55	4	11,95	21,69	22,63	23,33	—	—
2,0/0,5		3	25	1,95	60	4	11,95	26,74	27,84	28,62	—	—
2,0/0,5		3	30	1,95	70	4	11,95	31,8	33,02	—	—	—
2,5/0,25		3,7	8	2,4	45	4	9,28	9,84	10,29	10,69	11,04	11,37
2,5/0,25		3,7	10	2,4	45	4	11,15	11,86	12,39	12,84	13,24	13,6

Bestellbeispiel / Order example: 40-6120-1,2/0,2-6

Ø d1/R (0/-0,01) mm	40-6120	l2 mm	l3 mm	Hals Ø d3 mm	l1 mm	Ø d2 (h6) mm	Effektive Bearbeitungstiefe abhängig vom Konturwinkel (β) des Werkstückes. Effective machining depth depending on inclined angle (β) of workpiece.					
							TA-X	0,5°	1°	1,5°	2°	2,5°
	2,5/0,25							3,7	12	2,4	45	4
2,5/0,25		3,7	14	2,4	50	4	14,85	15,9	16,57	17,12	—	—
2,5/0,25		3,7	16	2,4	55	4	16,64	17,92	18,66	19,24	—	—
2,5/0,25		3,7	18	2,4	55	4	18,23	19,94	20,74	21,36	—	—
2,5/0,25		3,7	20	2,4	60	4	18,1	21,96	22,82	—	—	—
2,5/0,25		3,7	25	2,4	70	4	18,1	27	28,01	—	—	—
2,5/0,25		3,7	30	2,4	80	4	18,1	32,05	—	—	—	—
3,0/0,2		4,5	8	2,85	45	6	9,58	10,07	10,48	10,85	11,19	11,51
3,0/0,2		4,5	10	2,85	45	6	11,48	12,08	12,57	12,99	13,38	13,73
3,0/0,2		4,5	12	2,85	45	6	13,38	14,1	14,66	15,13	15,55	15,93
3,0/0,2		4,5	14	2,85	50	6	15,27	16,12	16,74	17,26	17,71	18,12
3,0/0,2		4,5	16	2,85	55	6	17,15	18,14	18,82	19,38	19,86	20,3
3,0/0,2		4,5	18	2,85	55	6	19	20,15	20,9	21,49	22,01	22,47
3,0/0,2		4,5	20	2,85	60	6	20,84	22,17	22,97	23,6	24,15	24,63
3,0/0,2		4,5	25	2,85	65	6	23,99	27,21	28,15	28,87	29,47	—
3,0/0,2		4,5	30	2,85	80	6	23,99	32,25	33,31	34,11	—	—
3,0/0,2		4,5	35	2,85	90	6	23,99	37,3	38,47	39,33	—	—
3,0/0,2		4,5	40	2,85	90	6	23,99	42,33	43,62	—	—	—
3,0/0,5		4,5	8	2,85	45	6	9,56	10,04	10,45	10,81	11,15	11,46
3,0/0,5		4,5	10	2,85	45	6	11,46	12,06	12,54	12,96	13,34	13,68
3,0/0,5		4,5	12	2,85	45	6	13,36	14,08	14,62	15,09	15,51	15,89
3,0/0,5		4,5	14	2,85	50	6	15,25	16,09	16,71	17,22	17,67	18,08
3,0/0,5		4,5	16	2,85	55	6	17,12	18,11	18,79	19,34	19,83	20,26
3,0/0,5		4,5	18	2,85	55	6	18,98	20,13	20,87	21,46	21,98	22,43
3,0/0,5		4,5	20	2,85	60	6	20,8	22,15	22,94	23,57	24,12	24,59
3,0/0,5		4,5	25	2,85	65	6	23,62	27,19	28,12	28,84	29,44	—
3,0/0,5		4,5	30	2,85	80	6	23,62	32,23	33,29	34,08	34,74	—
3,0/0,5		4,5	35	2,85	90	6	23,62	37,27	38,45	39,31	—	—
3,0/0,5		4,5	40	2,85	90	6	23,62	42,31	43,6	—	—	—
4,0/0,5		6	12	3,85	50	6	13,58	14,23	14,75	15,2	15,6	15,97
4,0/0,5		6	16	3,85	60	6	17,39	18,26	18,91	19,44	19,91	—
4,0/0,5		6	20	3,85	60	6	21,15	22,3	23,05	23,66	—	—
4,0/0,5		6	25	3,85	70	6	25,75	27,33	28,22	28,92	—	—
4,0/0,5		6	30	3,85	80	6	28,12	32,37	33,39	—	—	—
4,0/0,5		6	35	3,85	90	6	28,12	37,41	38,54	—	—	—
4,0/0,5		6	40	3,85	90	6	28,12	42,45	—	—	—	—
4,0/0,5		6	45	3,85	100	6	28,12	47,49	—	—	—	—
4,0/0,5		6	50	3,85	100	6	28,12	52,52	—	—	—	—
5,0/0,5		7,5	16	4,85	60	6	17,61	18,4	19,02	—	—	—
5,0/0,5		7,5	25	4,85	70	6	26,12	27,47	—	—	—	—
5,0/0,5		7,5	35	4,85	90	6	32,61	—	—	—	—	—
5,0/0,5		7,5	43	4,85	110	6	32,61	—	—	—	—	—
6,0/0,5		8,5	15	5,9	65	6	—	—	—	—	—	—
6,0/0,5		8,5	20	5,9	65	6	—	—	—	—	—	—
6,0/0,5		8,5	30	5,9	75	6	—	—	—	—	—	—
6,0/0,5		8,5	40	5,9	90	6	—	—	—	—	—	—
6,0/0,5		8,5	50	5,9	110	6	—	—	—	—	—	—

Bestellbeispiel / Order example: 40-6120-2,5/0,25-12

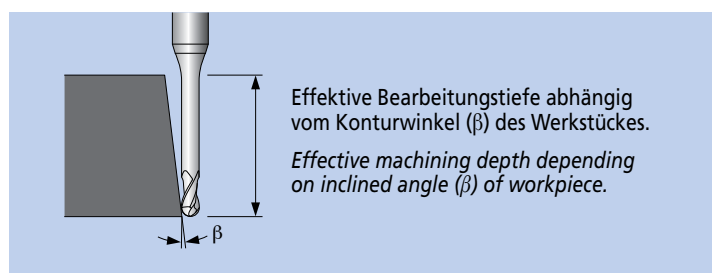

HAM 40-6130

Vollhartmetall-Torusfräser solid carbide toric end mill

W+F VHM Z 2 30° rechts Werk Norm
Typ H HA
HSF Eckradius HSC SHRINK FIT

- Konstruktions-Daten**
- langer Hals zum Rippenfräsen
 - zylindrischer Hals
 - extrem verstärkter Kern
 - Radiusform-Toleranz 0,01

- Engineering data**
- long neck for rib milling
 - cylindrical neck
 - strongly reinforced web thickness
 - radius form tolerance 0,01

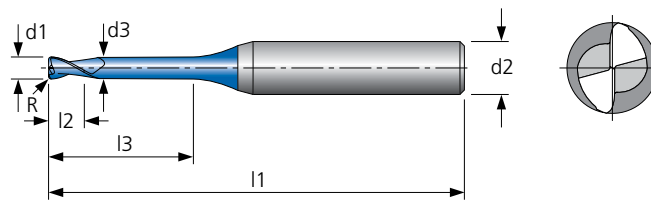

Material	Alu Knet-leg.	Alu Guss-leg.	Stahl < 800 N/mm²	Stahl < 1200 N/mm²	Stahl < 1600 N/mm²	Stahl < 55 HRC	Stahl < 60 HRC	Stahl < 66 HRC	INOX < 800 N/mm²	INOX > 800 N/mm²	GG	GGG	hochw. Legierungen	Titan	NE-Metalle Cu-Leg.	Graphit & Faser-verbund	MMS	max.	ohne	AIR
40-6130			○	●	●	●	●		○	○	●	●					●		●	●

Schnittdaten siehe Seite / cutting data available on page – 214

● sehr gut geeignet / very suitable ○ bedingt geeignet / limited suitable

Ø d1/R (0/-0,01) mm	40-6130						Effektive Bearbeitungstiefe abhängig vom Konturwinkel (β) des Werkstückes. Effective machining depth depending on inclined angle (β) of workpiece.					
	TA-X	l2 mm	l3 mm	Hals Ø d3 mm	l1 mm	Ø d2 (h6) mm	0,5°	1°	1,5°	2°	2,5°	3°
0,2/0,05		0,3	0,5	0,18	45	4	1,12	1,3	1,47	1,64	1,82	1,99
0,2/0,05		0,3	1	0,18	45	4	1,7	1,92	2,13	2,34	2,53	2,73
0,2/0,05		0,3	1,5	0,18	45	4	2,27	2,53	2,77	3	3,22	3,42
0,3/0,05		0,45	1	0,28	45	4	1,7	1,92	2,13	2,34	2,53	2,73
0,3/0,05		0,45	2	0,28	45	4	2,83	3,13	3,39	3,64	3,87	4,1
0,3/0,05		0,45	3	0,28	45	4	3,94	4,29	4,6	4,88	5,14	5,39
0,4/0,1		0,6	2	0,37	45	4	2,89	3,17	3,43	3,66	3,89	4,11
0,4/0,1		0,6	3	0,37	45	4	3,99	4,33	4,63	4,9	5,16	5,4
0,4/0,1		0,6	4	0,37	45	4	5,08	5,47	5,81	6,11	6,39	6,65
0,5/0,1		0,7	2	0,45	45	4	3	3,26	3,51	3,74	3,96	4,17
0,5/0,1		0,7	4	0,45	45	4	5,18	5,54	5,87	6,16	6,44	6,7
0,5/0,1		0,7	6	0,45	45	4	7,32	7,78	8,16	8,5	8,82	9,11
0,5/0,1		0,7	8	0,45	45	4	9,46	9,98	10,41	10,79	11,14	11,47
0,6/0,1		0,9	2	0,55	45	4	3	3,26	3,51	3,74	3,96	4,17
0,6/0,1		0,9	4	0,55	45	4	5,18	5,54	5,87	6,16	6,44	6,7
0,6/0,1		0,9	6	0,55	45	4	7,32	7,78	8,16	8,5	8,82	9,11
0,6/0,1		0,9	8	0,55	45	4	9,46	9,98	10,41	10,79	11,14	11,47
0,6/0,1		0,9	10	0,55	45	4	11,58	12,16	12,63	13,05	13,43	13,78
0,7/0,1		1	2	0,65	45	4	3	3,26	3,51	3,74	3,96	4,17
0,7/0,1		1	4	0,65	45	4	5,18	5,54	5,87	6,16	6,44	6,7
0,7/0,1		1	6	0,65	45	4	7,32	7,78	8,16	8,5	8,82	9,11
0,7/0,1		1	8	0,65	45	4	9,46	9,98	10,41	10,79	11,14	11,47
0,7/0,1		1	10	0,65	45	4	11,58	12,16	12,63	13,05	13,43	13,78
0,8/0,2		1,2	4	0,75	45	4	5,17	5,53	5,85	6,14	6,42	6,67
0,8/0,2		1,2	6	0,75	45	4	7,32	7,77	8,15	8,49	8,8	9,1
0,8/0,2		1,2	8	0,75	45	4	9,45	9,97	10,4	10,78	11,13	11,45
0,8/0,2		1,2	10	0,75	45	4	11,57	12,15	12,62	13,04	13,42	13,77
0,8/0,2		1,2	12	0,75	45	4	13,68	14,31	14,83	15,27	15,68	16,05
0,9/0,2		1,35	6	0,85	45	4	7,32	7,77	8,15	8,49	8,8	9,1
0,9/0,2		1,35	8	0,85	45	4	9,45	9,97	10,4	10,78	11,13	11,45
0,9/0,2		1,35	10	0,85	45	4	11,57	12,15	12,62	13,04	13,42	13,77
0,9/0,2		1,35	15	0,85	50	4	16,84	17,54	18,1	18,59	19,03	19,43
1,0/0,2		1,5	6	0,95	45	4	7,32	7,77	8,15	8,49	8,8	9,1
1,0/0,2		1,5	8	0,95	45	4	9,45	9,97	10,4	10,78	11,13	11,45
1,0/0,2		1,5	10	0,95	45	4	11,57	12,15	12,62	13,04	13,42	13,77
1,0/0,2		1,5	12	0,95	45	4	13,68	14,31	14,83	15,27	15,68	16,05
1,0/0,2		1,5	14	0,95	50	4	15,79	16,47	17,01	17,49	17,92	18,3
1,0/0,2		1,5	16	0,95	50	4	17,89	18,61	19,19	19,69	20,14	20,54

Bestellbeispiel / Order example: 40-6130-0,2/0,05-0,5

Ø d1/R (0/-0,01) mm	40-6130	l2	l3	Hals Ø d3	l1	Ø d2 (h6) mm	Effektive Bearbeitungstiefe abhängig vom Konturwinkel (β) des Werkstückes. Effective machining depth depending on inclined angle (β) of workpiece.					
							TA-X	mm	mm	mm	mm	mm
	0,5°	1°	1,5°	2°	2,5°	3°						
1,2/0,2		1,8	6	1,15	45	4	7,32	7,77	8,15	8,49	8,8	9,1
1,2/0,2		1,8	8	1,15	45	4	9,45	9,97	10,4	10,78	11,13	11,45
1,2/0,2		1,8	10	1,15	45	4	11,57	12,15	12,62	13,04	13,42	13,77
1,2/0,2		1,8	12	1,15	45	4	13,68	14,31	14,83	15,27	15,68	16,05
1,4/0,2		2,1	6	1,35	45	4	7,32	7,77	8,15	8,49	8,8	9,1
1,4/0,2		2,1	8	1,35	45	4	9,45	9,97	10,4	10,78	11,13	11,45
1,4/0,2		2,1	10	1,35	45	4	11,57	12,15	12,62	13,04	13,42	13,77
1,4/0,2		2,1	12	1,35	45	4	13,68	14,31	14,83	15,27	15,68	16,05
1,4/0,2		2,1	14	1,35	50	4	15,79	16,47	17,01	17,49	17,92	18,3
1,4/0,2		2,1	16	1,35	50	4	17,89	18,61	19,19	19,69	20,14	20,54
1,5/0,2		2,3	6	1,45	45	4	7,32	7,77	8,15	8,49	8,8	9,1
1,5/0,2		2,3	8	1,45	45	4	9,45	9,97	10,4	10,78	11,13	11,45
1,5/0,2		2,3	10	1,45	45	4	11,57	12,15	12,62	13,04	13,42	13,77
1,5/0,2		2,3	12	1,45	45	4	13,68	14,31	14,83	15,27	15,68	16,05
1,5/0,2		2,3	14	1,45	50	4	15,79	16,47	17,01	17,49	17,92	18,3
1,5/0,2		2,3	16	1,45	50	4	17,89	18,61	19,19	19,69	20,14	20,54
1,5/0,2		2,3	18	1,45	55	4	19,98	20,74	21,35	21,88	22,34	22,76
1,5/0,2		2,3	20	1,45	55	4	22,07	22,87	23,51	24,05	24,54	—
1,6/0,2		2,4	6	1,55	45	4	7,32	7,77	8,15	8,49	8,8	9,1
1,6/0,2		2,4	8	1,55	45	4	9,45	9,97	10,4	10,78	11,13	11,45
1,6/0,2		2,4	10	1,55	45	4	11,57	12,15	12,62	13,04	13,42	13,77
1,6/0,2		2,4	12	1,55	45	4	13,68	14,31	14,83	15,27	15,68	16,05
1,6/0,2		2,4	14	1,55	50	4	15,79	16,47	17,01	17,49	17,92	18,3
1,6/0,2		2,4	16	1,55	50	4	17,89	18,61	19,19	19,69	20,14	20,54
1,6/0,2		2,4	18	1,55	55	4	19,98	20,74	21,35	21,88	22,34	22,76
1,6/0,2		2,4	20	1,55	55	4	22,07	22,87	23,51	24,05	24,54	—
1,8/0,2		2,7	6	1,75	45	4	7,32	7,77	8,15	8,49	8,8	9,1
1,8/0,2		2,7	8	1,75	45	4	9,45	9,97	10,4	10,78	11,13	11,45
1,8/0,2		2,7	10	1,75	45	4	11,57	12,15	12,62	13,04	13,42	13,77
1,8/0,2		2,7	12	1,75	45	4	13,68	14,31	14,83	15,27	15,68	16,05
1,8/0,2		2,7	14	1,75	50	4	15,79	16,47	17,01	17,49	17,92	18,3
1,8/0,2		2,7	16	1,75	50	4	17,89	18,61	19,19	19,69	20,14	20,54
1,8/0,2		2,7	18	1,75	55	4	19,98	20,74	21,35	21,88	22,34	—
1,8/0,2		2,7	20	1,75	55	4	22,07	22,87	23,51	24,05	24,54	—
2,0/0,2		3	6	1,95	45	4	7,32	7,77	8,15	8,49	8,8	9,1
2,0/0,2		3	8	1,95	45	4	9,45	9,97	10,4	10,78	11,13	11,45
2,0/0,2		3	10	1,95	45	4	11,57	12,15	12,62	13,04	13,42	13,77
2,0/0,2		3	12	1,95	45	4	13,68	14,31	14,83	15,27	15,68	16,05
2,0/0,2		3	14	1,95	50	4	15,79	16,47	17,01	17,49	17,92	18,3
2,0/0,2		3	16	1,95	50	4	17,89	18,61	19,19	19,69	20,14	—
2,0/0,2		3	18	1,95	55	4	19,98	20,74	21,35	21,88	22,34	—
2,0/0,2		3	20	1,95	55	4	22,07	22,87	23,51	24,05	—	—
2,0/0,2		3	25	1,95	60	4	27,27	28,16	28,86	—	—	—
2,0/0,2		3	30	1,95	70	4	32,46	33,43	34,18	—	—	—
2,0/0,5		3	6	1,95	45	4	7,3	7,73	8,11	8,44	8,75	9,04
2,0/0,5		3	8	1,95	45	4	9,43	9,94	10,36	10,74	11,08	11,4
2,0/0,5		3	10	1,95	45	4	11,55	12,12	12,59	13	13,38	13,72
2,0/0,5		3	12	1,95	45	4	13,67	14,29	14,8	15,24	15,64	16,01
2,0/0,5		3	14	1,95	50	4	15,77	16,44	16,99	17,46	17,88	18,27
2,0/0,5		3	16	1,95	50	4	17,87	18,59	19,16	19,66	20,1	—
2,0/0,5		3	18	1,95	55	4	19,96	20,72	21,33	21,85	22,31	—
2,0/0,5		3	20	1,95	55	4	22,05	22,85	23,48	24,03	—	—
2,0/0,5		3	25	1,95	60	4	27,26	28,15	28,84	—	—	—
2,0/0,5		3	30	1,95	70	4	32,45	33,41	34,16	—	—	—
2,5/0,25		3,7	8	2,4	45	4	9,62	10,09	10,5	10,87	11,21	11,52
2,5/0,25		3,7	10	2,4	45	4	11,73	12,26	12,72	13,12	13,49	13,83

Bestellbeispiel / Order example: 40-6130 - 1,2/0,2-6

Ø d1/R (0/-0,01) mm	40-6130	l2 mm	l3 mm	Hals Ø d3 mm	l1 mm	Ø d2 (h6) mm	Effektive Bearbeitungstiefe abhängig vom Konturwinkel (β) des Werkstückes. Effective machining depth depending on inclined angle (β) of workpiece.					
	TA-X						0,5°	1°	1,5°	2°	2,5°	3°
2,5/0,25		3,7	12	2,4	45	4	13,83	14,42	14,91	15,35	15,74	—
2,5/0,25		3,7	14	2,4	50	4	15,92	16,57	17,1	17,56	—	—
2,5/0,25		3,7	16	2,4	55	4	18,01	18,7	19,26	19,75	—	—
2,5/0,25		3,7	18	2,4	55	4	20,1	20,83	21,42	—	—	—
2,5/0,25		3,7	20	2,4	60	4	22,18	22,95	23,57	—	—	—
2,5/0,25		3,7	25	2,4	70	4	27,38	28,24	—	—	—	—
2,5/0,25		3,7	30	2,4	80	4	32,56	33,49	—	—	—	—
3,0/0,2		4,5	8	2,85	45	6	9,77	10,22	10,61	10,97	11,3	11,61
3,0/0,2		4,5	10	2,85	45	6	11,87	12,38	12,82	13,21	13,57	13,9
3,0/0,2		4,5	12	2,85	45	6	13,97	14,53	15,01	15,43	15,82	16,17
3,0/0,2		4,5	14	2,85	50	6	16,05	16,67	17,18	17,63	18,04	18,42
3,0/0,2		4,5	16	2,85	55	6	18,14	18,8	19,35	19,82	20,26	20,65
3,0/0,2		4,5	18	2,85	55	6	20,22	20,92	21,5	22	22,45	22,86
3,0/0,2		4,5	20	2,85	60	6	22,3	23,04	23,65	24,17	24,64	25,07
3,0/0,2		4,5	25	2,85	65	6	27,48	28,32	28,99	29,56	30,07	—
3,0/0,2		4,5	30	2,85	80	6	32,65	33,57	34,29	34,91	—	—
3,0/0,2		4,5	35	2,85	90	6	37,81	38,8	39,57	40,22	—	—
3,0/0,2		4,5	40	2,85	90	6	42,96	44,01	44,83	—	—	—
3,0/0,5		4,5	8	2,85	45	6	9,76	10,2	10,58	10,93	11,25	11,56
3,0/0,5		4,5	10	2,85	45	6	11,86	12,36	12,79	13,18	13,53	13,86
3,0/0,5		4,5	12	2,85	45	6	13,95	14,51	14,98	15,4	15,78	16,13
3,0/0,5		4,5	14	2,85	50	6	16,04	16,65	17,16	17,6	18,01	18,38
3,0/0,5		4,5	16	2,85	55	6	18,13	18,78	19,32	19,8	20,22	20,62
3,0/0,5		4,5	18	2,85	55	6	20,21	20,9	21,48	21,98	22,42	22,83
3,0/0,5		4,5	20	2,85	60	6	22,29	23,02	23,63	24,15	24,61	25,04
3,0/0,5		4,5	25	2,85	65	6	27,47	28,3	28,97	29,54	30,04	—
3,0/0,5		4,5	30	2,85	80	6	32,64	33,55	34,27	34,89	—	—
3,0/0,5		4,5	35	2,85	90	6	37,8	38,78	39,56	40,21	—	—
3,0/0,5		4,5	40	2,85	90	6	42,95	44	44,81	—	—	—
4,0/0,5		6	12	3,85	50	6	13,95	14,51	14,98	15,4	15,78	16,13
4,0/0,5		6	16	3,85	60	6	18,13	18,78	19,32	19,8	20,22	—
4,0/0,5		6	20	3,85	60	6	22,29	23,02	23,63	24,15	—	—
4,0/0,5		6	25	3,85	70	6	27,47	28,3	28,97	—	—	—
4,0/0,5		6	30	3,85	80	6	32,64	33,55	34,27	—	—	—
4,0/0,5		6	35	3,85	90	6	37,8	38,78	—	—	—	—
4,0/0,5		6	40	3,85	90	6	42,95	44	—	—	—	—
4,0/0,5		6	45	3,85	100	6	48,09	49,2	—	—	—	—
4,0/0,5		6	50	3,85	100	6	53,23	54,39	—	—	—	—
5,0/0,5		7,5	16	4,85	60	6	18,13	18,78	19,32	—	—	—
5,0/0,5		7,5	25	4,85	70	6	27,47	28,3	—	—	—	—
5,0/0,5		7,5	35	4,85	90	6	37,8	38,78	—	—	—	—
5,0/0,5		7,5	43	4,85	110	6	45,98	47,06	—	—	—	—
6,0/0,5		8,5	15	5,9	65	6	—	—	—	—	—	—
6,0/0,5		8,5	20	5,9	65	6	—	—	—	—	—	—
6,0/0,5		8,5	30	5,9	75	6	—	—	—	—	—	—
6,0/0,5		8,5	40	5,9	90	6	—	—	—	—	—	—
6,0/0,5		8,5	50	5,9	110	6	—	—	—	—	—	—

Bestellbeispiel / Order example: 40-6130-2,5/0,25-12

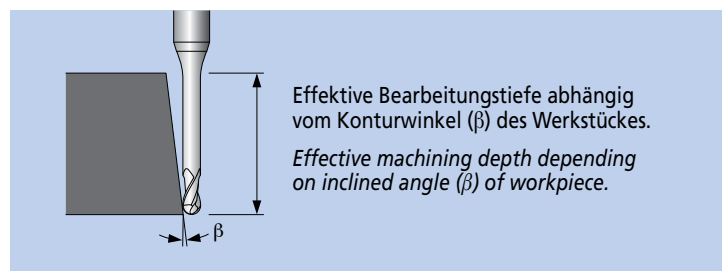

HAM 40-5360

Vollhartmetall-Torusfräser solid carbide toric end mill

W+F VHM Z 2 28° rechts Werk Norm
Typ H HA
HSF Eckradius HSC SHRINK FIT
HB

Konstruktions-Daten

- Hals abgesetzt
- zentrumsschneidend
- Radiusform-Toleranz 0,02

Engineering data

- reduced neck
- centre cutting
- radius form tolerance 0,02

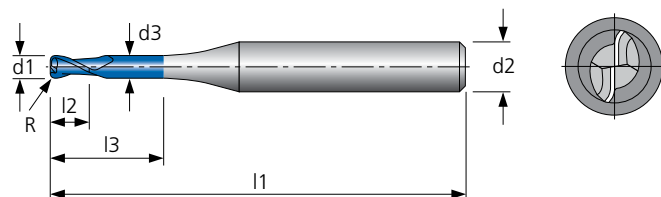

Material	Alu Knet-leg.	Alu Guss-leg.	Stahl < 800 N/mm²	Stahl < 1200 N/mm²	Stahl < 1600 N/mm²	Stahl < 55 HRC	Stahl < 60 HRC	Stahl < 66 HRC	INOX < 800 N/mm²	INOX > 800 N/mm²	GG	GGG	hochw. Legierungen	Titan	NE-Metalle Cu-Leg.	Graphit & Faser-verbund	MMS	max.	ohne	AIR
40-5360			●	●	●	○			○	○	●	●					●		●	●

Schnittdaten siehe Seite / cutting data available on page - 216

● sehr gut geeignet / very suitable ○ bedingt geeignet / limited suitable

Ø d1/R (e8) mm	40-5360	l2 mm	l3 mm	Hals Ø d3 mm	l1 mm	Ø d2 (h6) mm	Ø d1/R (e8) mm	40-5360	l2 mm	l3 mm	Hals Ø d3 mm	l1 mm	Ø d2 (h6) mm
	TA-X							TA-X					
0,5/0,05		0,7	2	0,48	45	4	2,0/0,2		2,8	10	1,95	60	4
0,5/0,05		0,7	6	0,48	45	4	2,0/0,2		2,8	15	1,95	60	4
0,6/0,06		0,9	2	0,57	45	4	2,0/0,2		2,8	20	1,95	60	4
0,6/0,06		0,9	8	0,57	45	4	2,5/0,25		3,5	8	2,4	60	4
0,8/0,08		1,2	4	0,77	45	4	2,5/0,25		3,5	15	2,4	60	4
0,8/0,08		1,2	6	0,77	45	4	3,0/0,3		4	10	2,9	60	6
0,8/0,08		1,2	8	0,77	45	4	3,0/0,3		4	15	2,9	60	6
1,0/0,1		1,6	6	0,95	45	4	3,0/0,3		4	20	2,9	65	6
1,0/0,1		1,6	10	0,95	45	4	3,0/0,3		4	25	2,9	65	6
1,0/0,1		1,6	15	0,95	45	4	4,0/0,5		5	15	3,9	70	6
1,2/0,12		1,9	6	1,15	50	4	4,0/0,5		5	20	3,9	70	6
1,2/0,12		1,9	12	1,15	50	4	4,0/0,5		5	25	3,9	70	6
1,5/0,15		2,4	6	1,45	55	4	5,0/0,5		6	15	4,9	70	6
1,5/0,15		2,4	8	1,45	55	4	5,0/0,5		6	20	4,9	70	6
1,5/0,15		2,4	15	1,45	55	4	5,0/0,5		6	25	4,9	70	6
1,5/0,15		2,4	20	1,45	55	4	6,0/0,5		9	32	5,8	75	6
2,0/0,2		2,8	6	1,95	60	4	6,0/1		9	32	5,8	75	6

Bestellbeispiel / Order example: HA-Schaft/shank 40-5360-2,0/0,2-10
 HB-Schaft/shank 40-5360-2,0/0,2-10-HB

HAM 40-5600

Vollhartmetall-Torusfräser solid carbide toric end mill

W+F
VHM
Z 4
35° rechts
Werk Norm

Typ W
DIN 6535 HA

Eckradius
HSC
SHRINK FIT

Konstruktions-Daten

- zentrumsschneidend
- verstärkter Kern
- Diamantbeschichtung für abrasive Werkstoffe
- Radiusform-Toleranz 0,02

Engineering data

- centre cutting
- reinforced web thickness
- diamond coating for abrasive materials
- radius form tolerance 0,02

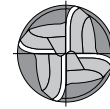
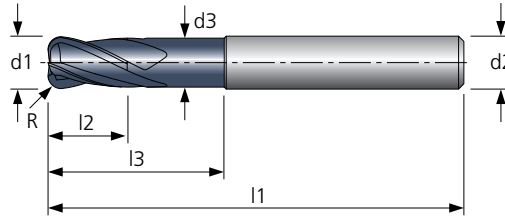

Material	Alu Knet-leg.	Alu Guss-leg.	Stahl < 800 N/mm²	Stahl < 1200 N/mm²	Stahl < 1600 N/mm²	Stahl < 55 HRC	Stahl < 60 HRC	Stahl < 66 HRC	INOX < 800 N/mm²	INOX > 800 N/mm²	GG	GGG	hochw. Legierungen	Titan	NE-Metalle Cu-Leg.	Graphit & Faser-verbund	MMS	max.	ohne	AIR
40-5600																	●	○	●	

Schnittdaten siehe Seite / cutting data available on page – 217

● sehr gut geeignet / very suitable ○ bedingt geeignet / limited suitable

Ø d1/R (0/-0,01) mm	40-5600	l2 mm	l3 mm	Hals Ø d3 mm	l1 mm	Ø d2 (h6) mm
	Diamant					
2/0,2		3	30	1,92	65	4
2/0,5		3	30	1,92	65	4
3/0,3		4	40	2,9	65	4
3/0,5		4	40	2,9	65	4
4/0,3		5	50	3,9	80	4
4/0,5		5	50	3,9	80	4
6/0,3		8	60	5,8	100	6
6/0,5		8	60	5,8	100	6
6/1		8	60	5,8	100	6
8/1		10	84	7,8	120	8

Ø d1/R (0/-0,01) mm	40-5600	l2 mm	l3 mm	Hals Ø d3 mm	l1 mm	Ø d2 (h6) mm
	Diamant					
8/2		10	84	7,8	120	8
10/1		12	88	9,8	130	10
10/2		12	88	9,8	130	10
12/1		15	93	11,8	140	12
12/2		15	93	11,8	140	12
12/3		15	93	11,8	140	12

Bestellbeispiel / Order example: 40-5600-8/2

HAM 40-5500

Vollhartmetall-Torusfräser solid carbide toric end mill

W+F VHM Z 3-4 0° Nut Werk Norm

Typ H HA

HSF Eckradius HSC SHRINK FIT

Konstruktions-Daten

- verstärkter Kern
- ideal geeignet für tiefe Konturen
- vibrationsarm
- zentrumschneidend
- bis Ø 6,0 mm
Radiusform-Toleranz 0,01
- ab Ø 7,0 mm
Radiusform-Toleranz 0,02

Engineering data

- reinforced web thickness
- very good for deep contours
- low vibrations
- centre cutting
- up to Ø 6,0 mm
radius form tolerance 0,01
- from Ø 7,0 mm
radius form tolerance 0,02

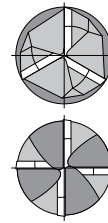
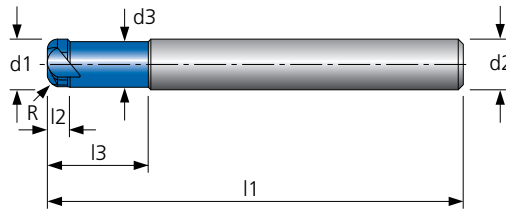

Material	Alu Knet-leg.	Alu Guss-leg.	Stahl < 800 N/mm²	Stahl < 1200 N/mm²	Stahl < 1600 N/mm²	Stahl < 55 HRC	Stahl < 60 HRC	Stahl < 66 HRC	INOX < 800 N/mm²	INOX > 800 N/mm²	GG	GGG	hochw. Legierungen	Titan	NE-Metalle Cu-Leg.	Graphit & Faser-verbund	MMS	max.	ohne	AIR
40-5500			○	●	●	●	●	●			●	●					●		○	●

Schnittdaten siehe Seite / cutting data available on page – 218

● sehr gut geeignet / very suitable ○ bedingt geeignet / limited suitable

Ø d1/R (e8) mm	40-5500	l2 mm	l3 mm	Hals Ø d3 mm	l1 mm	Z	Ø d2 (h6) mm
	TA-X						
2/0,5		0,8	5	1,8	60	3	6
3/0,75		1,2	7,5	2,7	60	4	6
4/1		1,6	10	3,6	70	4	6
5/1,2		2	12,5	4,5	80	4	6
6/1,5		2,5	24	5,4	55	4	6
6/1,5		2,5	12	5,4	90	4	6
7/1,5		3	—	—	90	4	6
8/2		3,5	32	7,2	65	4	8
8/2		3,5	16	7,2	104	4	8
9/2		4	—	—	104	4	8

Ø d1/R (e8) mm	40-5500	l2 mm	l3 mm	Hals Ø d3 mm	l1 mm	Z	Ø d2 (h6) mm
	TA-X						
10/2		4	40	9	75	4	10
10/2		4	20	9	104	4	10
11/2		4,5	—	—	104	4	10
12/3		5	48	11	83	4	12
12/3		5	24	11	104	4	12
13/3		5,5	—	—	104	4	12
16/4		6,5	28	14	104	4	16

Bestellbeispiel / Order example: 40-5500-10/2-40

HAM 40-5520

Vollhartmetall-Torusfräser solid carbide toric end mill

W+F VHM Z 4 30° rechts Werk Norm
Typ H DIN 6535 HA
HSF Eckradius HSC SHRINK FIT
DIN 6535 HB

Konstruktions-Daten

- zentrumsschneidend
- spezielle Ausspitzung
- verstärkter Kern
- Radiusform-Toleranz 0,02

Engineering data

- centre cutting
- special web thinning
- reinforced web thickness
- radius form tolerance 0,02

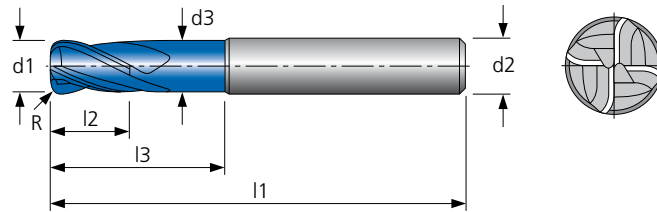

Material	Alu Knet-leg.	Alu Guss-leg.	Stahl < 800 N/mm²	Stahl < 1200 N/mm²	Stahl < 1600 N/mm²	Stahl < 55 HRC	Stahl < 60 HRC	Stahl < 66 HRC	INOX < 800 N/mm²	INOX > 800 N/mm²	GG	GGG	hochw. Legierungen	Titan	NE-Metalle Cu-Leg.	Graphit & Faser-verbund	MMS	max.	ohne	AIR
40-5520			●	●	●	○			○	○	●	●					●	○	●	●

Schnittdaten siehe Seite / cutting data available on page – 219

● sehr gut geeignet / very suitable ○ bedingt geeignet / limited suitable

Ø d1/R (0/-0,01) mm	40-5520	l2 mm	l3 mm	Hals Ø d3 mm	l1 mm	Ø d2 (h6) mm
	TA-X					
2/0,2		3	13	1,9	50	3
2/0,2		3	13	1,9	50	4
3/0,5		4	14	2,7	50	3
3/0,5		4	14	2,7	50	4
3/1		4	14	2,7	50	3
3/1		4	14	2,7	50	4
4/0,5		5	16	3,7	50	4
4/1		5	16	3,7	50	4
5/0,5		6	18	4,6	54	5
5/0,5		6	18	4,6	54	6
5/1		6	18	4,6	54	5
5/1		6	18	4,6	54	6
6/0,5		7	21	5,5	57	6
6/1		7	21	5,5	57	6
6/1,5		7	21	5,5	57	6

Ø d1/R (0/-0,01) mm	40-5520	l2 mm	l3 mm	Hals Ø d3 mm	l1 mm	Ø d2 (h6) mm
	TA-X					
8/0,5		9	27	7,4	63	8
8/1		9	27	7,4	63	8
8/1,5		9	27	7,4	63	8
8/2		9	27	7,4	63	8
8/3		9	27	7,4	63	8
10/0,5		11	32	9,2	72	10
10/1		11	32	9,2	72	10
10/1,5		11	32	9,2	72	10
10/2		11	32	9,2	72	10
12/0,5		12	38	11	83	12
12/1		12	38	11	83	12
12/1,5		12	38	11	83	12
12/2		12	38	11	83	12
16/2		16	47	15	105	16

Bestellbeispiel / Order example: HA-Schaft /shank 40-5520-8/0,5-27-8
HB-Schaft /shank 40-5520-8/0,5-27-8-HB

HAM 40-5560

Vollhartmetall-Torusfräser solid carbide toric end mill

W+F VHM Z 4 30° rechts Werk Norm
Typ H DIN 6535 HA
HSF Eckradius HSC SHRINK FIT
DIN 6535 HB

Konstruktions-Daten

- zentrumsschneidend
- spezielle Ausspitzung
- verstärkter Kern
- Radiusform-Toleranz 0,02

Engineering data

- centre cutting
- special web thinning
- reinforced web thickness
- radius form tolerance 0,02

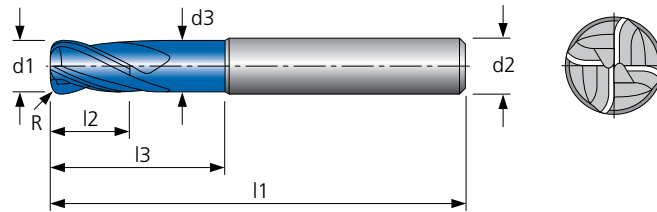

Material	Alu Knet-leg.	Alu Guss-leg.	Stahl < 800 N/mm²	Stahl < 1200 N/mm²	Stahl < 1600 N/mm²	Stahl < 55 HRC	Stahl < 60 HRC	Stahl < 66 HRC	INOX < 800 N/mm²	INOX > 800 N/mm²	GG	GGG	hochw. Legierungen	Titan	NE-Metalle Cu-Leg.	Graphit & Faser-verbund	MMS	max.	ohne	AIR
40-5560			●	●	●	○			○	○	●	●					●	○	●	●

Schnittdaten siehe Seite / cutting data available on page – 219

● sehr gut geeignet / very suitable ○ bedingt geeignet / limited suitable

Ø d1/R (0/-0,01) mm	40-5560	l2 mm	l3 mm	Hals Ø d3 mm	l1 mm	Ø d2 (h6) mm
	TA-X					
2/0,2		3	27	1,9	75	3
2/0,2		3	27	1,9	75	4
3/0,5		4	32	2,7	75	3
3/0,5		4	32	2,7	75	4
3/1		4	32	2,7	75	3
3/1		4	32	2,7	75	4
4/0,5		5	36	3,7	75	4
4/1		5	36	3,7	75	4
5/0,5		6	40	4,6	75	5
5/0,5		6	40	4,6	75	6
5/1		6	40	4,6	75	5
5/1		6	40	4,6	75	6
6/0,5		7	44	5,5	80	6
6/1		7	44	5,5	80	6
6/1,5		7	44	5,5	80	6

Ø d1/R (0/-0,01) mm	40-5560	l2 mm	l3 mm	Hals Ø d3 mm	l1 mm	Ø d2 (h6) mm
	TA-X					
8/0,5		9	54	7,4	100	8
8/1		9	54	7,4	100	8
8/1,5		9	54	7,4	100	8
8/2		9	54	7,4	100	8
10/0,5		11	60	9,2	100	10
10/1		11	60	9,2	100	10
10/1,5		11	60	9,2	100	10
10/2		11	60	9,2	100	10
12/0,5		12	75	11	120	12
12/1		12	75	11	120	12
12/1,5		12	75	11	120	12
12/2		12	75	11	120	12
16/2		16	92	15	150	16

Bestellbeispiel / Order example: HA-Schaft /shank 40-5560-8/0,5-54-8
HB-Schaft /shank 40-5560-8/0,5-54-8-HB

Projektengineering

project engineering

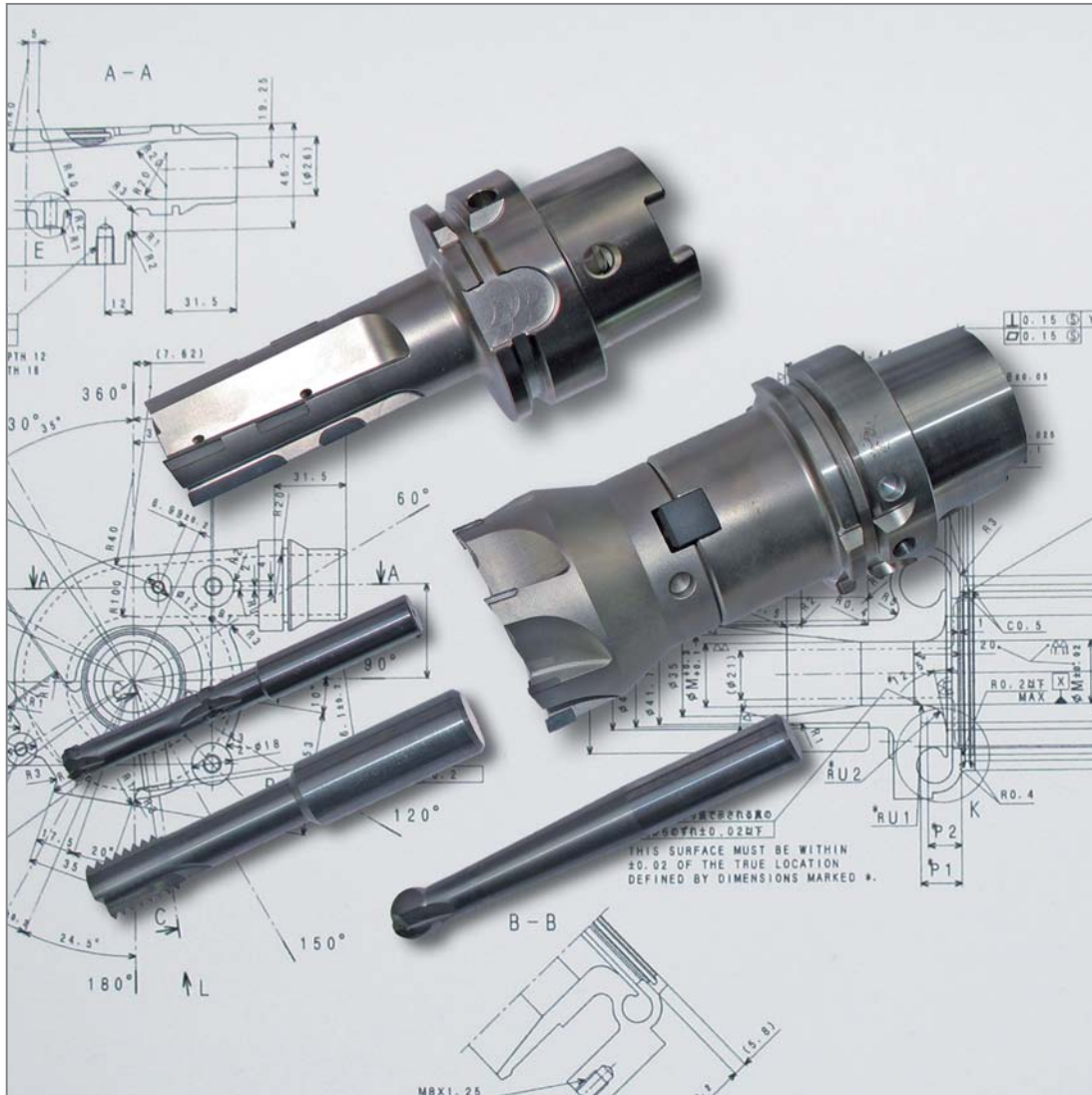

Partnerschaft vom Projektengineering
bis zum Toolmanagement.

*Partnership from Project Engineering
to Toolmanagement.*



Radiusfräser

ball nose end mills

Vollhartmetall-Radiusfräser
in verschiedenen Ausführungen.

*Solid carbide ball nose end mills
in different types.*

HAM 40-5860

Vollhartmetall-Radiusfräser solid carbide ball nose end mill

W+F
VHM
Z 2
30° rechts
Werk Norm

Typ W
DIN 6535 HA

HSF
HSC
SHRINK FIT

Konstruktions-Daten

- besonders geeignet zum Kopierfräsen tiefer Konturbereiche
- zentrumsschneidend
- Radiusform-Toleranz 0,01

Engineering data

- especially suitable for form copying of deep contours
- centre cutting
- radius form tolerance 0,01

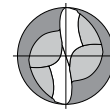
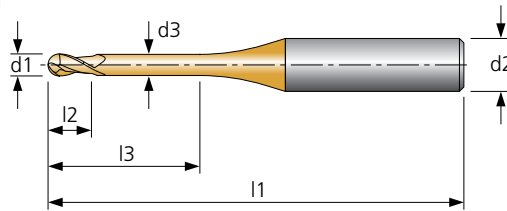

Material	Alu Knet-leg.	Alu Guss-leg.	Stahl < 800 N/mm²	Stahl < 1200 N/mm²	Stahl < 1600 N/mm²	Stahl < 55 HRC	Stahl < 60 HRC	Stahl < 66 HRC	INOX < 800 N/mm²	INOX > 800 N/mm²	GG	G GG	hochw. Legierungen	Titan	NE-Metalle Cu-Leg.	Graphit & Faser-verbund	MMS	max.	ohne	AIR
40-5860	●	●							○	○				○	●	○	●	●	○	○

Schnittdaten siehe Seite / cutting data available on page – 220

● sehr gut geeignet / very suitable ○ bedingt geeignet / limited suitable

Ø d1 (0/-0,01) mm	40-5860	l2 mm	l3 mm	Hals Ø d3 mm	l1 mm	Ø d2 (h6) mm	Ø d1 (0/-0,01) mm	40-5860	l2 mm	l3 mm	Hals Ø d3 mm	l1 mm	Ø d2 (h6) mm
	TA-AL							TA-AL					
0,2		0,3	0,5	0,18	55	4	1,5		2	18	1,44	55	4
0,2		0,3	1	0,18	55	4	1,5		2	24	1,44	60	4
0,2		0,3	1,5	0,18	55	4	2		2,5	6	1,92	65	4
0,3		0,45	1	0,28	55	4	2		2,5	10	1,92	65	4
0,3		0,45	2	0,28	55	4	2		2,5	14	1,92	65	4
0,3		0,45	3	0,28	55	4	2		2,5	18	1,92	65	4
0,4		0,6	2	0,37	55	4	2		2,5	24	1,92	75	4
0,4		0,6	3	0,37	55	4	2		2,5	30	1,92	75	4
0,4		0,6	4	0,37	55	4	2,5		3,5	10	2,4	65	4
0,5		0,7	3	0,47	55	4	2,5		3,5	20	2,4	65	4
0,5		0,7	5	0,47	55	4	2,5		3,5	30	2,4	75	4
0,5		0,7	8	0,47	55	4	3		5	6	2,9	65	4
0,6		0,9	3	0,57	55	4	3		5	10	2,9	65	4
0,6		0,9	5	0,57	55	4	3		5	14	2,9	65	4
0,6		0,9	8	0,57	55	4	3		5	18	2,9	65	4
0,8		1,1	4	0,76	55	4	3		5	24	2,9	75	4
0,8		1,1	6	0,76	55	4	3		5	30	2,9	75	4
0,8		1,1	8	0,76	55	4	4		6	10	3,9	65	6
0,8		1,1	10	0,76	55	4	4		6	14	3,9	65	6
1		1,5	6	0,95	55	4	4		6	18	3,9	65	6
1		1,5	10	0,95	55	4	4		6	24	3,9	75	6
1		1,5	14	0,95	55	4	4		6	30	3,9	75	6
1		1,5	18	0,95	55	4	5		7,5	10	4,9	65	6
1		1,5	24	0,95	60	4	5		7,5	20	4,9	65	6
1,2		1,6	6	1,15	55	4	5		7,5	30	4,9	75	6
1,2		1,6	10	1,15	55	4	5		7,5	40	4,9	90	6
1,2		1,6	14	1,15	55	4	6		10	12	5,9	65	6
1,2		1,6	18	1,15	55	4	6		10	20	5,9	65	6
1,2		1,6	24	1,15	60	4	6		10	30	5,9	75	6
1,5		2	6	1,44	55	4	6		10	40	5,9	90	6
1,5		2	10	1,44	55	4	6		10	50	5,9	90	6
1,5		2	14	1,44	55	4	6		10	50	5,9	90	6

Bestellbeispiel / Order example: 40-5860-1,5-18

HAM 40-5880

Vollhartmetall-Radiusfräser solid carbide ball nose end mill

W+F VHM Z 2 35° rechts Werk Norm
Typ W DIN 6535 HA
HSC SHRINK FIT

Konstruktions-Daten

- Diamantbeschichtung für abrasive Werkstoffe
- zentrumsschneidend
- verstärkter Kern
- Radiusform-Toleranz 0,01

Engineering data

- diamond coating for abrasive materials
- centre cutting
- reinforced web thickness
- radius form tolerance 0,01

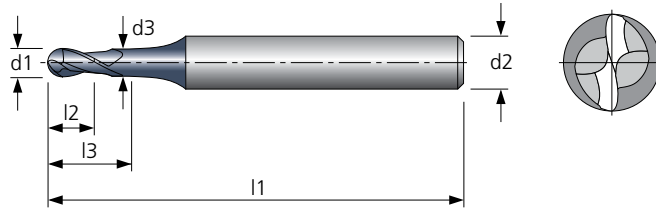

Material	Alu Knet-leg.	Alu Guss-leg.	Stahl < 800 N/mm²	Stahl < 1200 N/mm²	Stahl < 1600 N/mm²	Stahl < 55 HRC	Stahl < 60 HRC	Stahl < 66 HRC	INOX < 800 N/mm²	INOX > 800 N/mm²	GG	GGG	hochw. Legierungen	Titan	NE-Metalle Cu-Leg.	Graphit & Faser-verbund	MMS	max.	ohne	AIR
40-5880																●	○		●	

Schnittdaten siehe Seite / cutting data available on page – 221

● sehr gut geeignet / very suitable ○ bedingt geeignet / limited suitable

Ø d1 (0/-0,01) mm	40-5880	l2 mm	l3 mm	Hals Ø d3 mm	l1 mm	Ø d2 (h6) mm	Ø d1 (0/-0,01) mm	40-5880	l2 mm	l3 mm	Hals Ø d3 mm	l1 mm	Ø d2 (h6) mm
	Diamant							Diamant					
0,2		0,3	0,5	0,18	55	4	1,5		2	18	1,44	55	4
0,2		0,3	1	0,18	55	4	1,5		2	24	1,44	60	4
0,2		0,3	1,5	0,18	55	4	2		2,5	6	1,92	65	4
0,3		0,45	1	0,28	55	4	2		2,5	10	1,92	65	4
0,3		0,45	2	0,28	55	4	2		2,5	14	1,92	65	4
0,3		0,45	3	0,28	55	4	2		2,5	18	1,92	65	4
0,4		0,6	2	0,37	55	4	2		2,5	24	1,92	75	4
0,4		0,6	3	0,37	55	4	2		2,5	30	1,92	75	4
0,4		0,6	4	0,37	55	4	2,5		3,5	10	2,4	65	4
0,5		0,7	3	0,47	55	4	2,5		3,5	20	2,4	65	4
0,5		0,7	5	0,47	55	4	2,5		3,5	30	2,4	75	4
0,5		0,7	8	0,47	55	4	3		5	6	2,9	65	4
0,6		0,9	3	0,57	55	4	3		5	10	2,9	65	4
0,6		0,9	5	0,57	55	4	3		5	14	2,9	65	4
0,6		0,9	8	0,57	55	4	3		5	18	2,9	65	4
0,8		1,1	4	0,76	55	4	3		5	24	2,9	75	4
0,8		1,1	6	0,76	55	4	3		5	30	2,9	75	4
0,8		1,1	8	0,76	55	4	4		6	10	3,9	65	6
0,8		1,1	10	0,76	55	4	4		6	14	3,9	65	6
1		1,5	6	0,95	55	4	4		6	18	3,9	65	6
1		1,5	10	0,95	55	4	4		6	24	3,9	75	6
1		1,5	14	0,95	55	4	4		6	30	3,9	75	6
1		1,5	18	0,95	55	4	5		7,5	10	4,9	65	6
1		1,5	24	0,95	60	4	5		7,5	20	4,9	65	6
1,2		1,6	6	1,15	55	4	5		7,5	30	4,9	75	6
1,2		1,6	10	1,15	55	4	5		7,5	40	4,9	90	6
1,2		1,6	14	1,15	55	4	6		10	12	5,9	65	6
1,2		1,6	18	1,15	55	4	6		10	20	5,9	65	6
1,2		1,6	24	1,15	60	4	6		10	30	5,9	75	6
1,5		2	6	1,44	55	4	6		10	40	5,9	90	6
1,5		2	10	1,44	55	4	6		10	50	5,9	90	6
1,5		2	14	1,44	55	4	6		10	50	5,9	90	6

Bestellbeispiel / Order example: 40-5880-1,5-18

HAM 40-6080

Vollhartmetall-Radiusfräser solid carbide ball nose end mill

W+F VHM Z 2 30° rechts Werk Norm
Typ H HA
HSF HSC SHRINK FIT

Konstruktions-Daten

- konischer Hals 0,9°
- langer Hals zum Rippenfräsen
- extrem verstärkter Kern
- Radiusform-Toleranz 0,01

Engineering data

- conical neck 0,9°
- long neck for rib milling
- strongly reinforced web thickness
- radius form tolerance 0,01

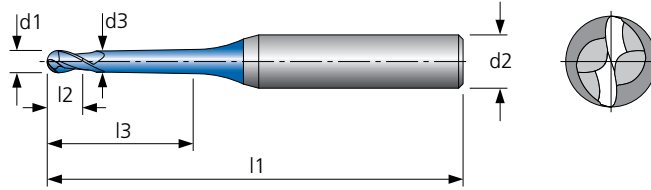

Material	Alu Knet-leg.	Alu Guss-leg.	Stahl < 800 N/mm²	Stahl < 1200 N/mm²	Stahl < 1600 N/mm²	Stahl < 55 HRC	Stahl < 60 HRC	Stahl < 66 HRC	INOX < 800 N/mm²	INOX > 800 N/mm²	GG	GGG	hochw. Legierungen	Titan	NE-Metalle Cu-Leg.	Graphit & Faserverbund	MMS	max.	ohne	AIR
40-6080			●	●	●	●	●		○	○	●	●					●		●	●

Schnittdaten siehe Seite / cutting data available on page – 222

● sehr gut geeignet / very suitable ○ bedingt geeignet / limited suitable

Ø d1 (0/-0,01) mm	40-6080	l2	l3	Hals Ø d3	l1	Ø d2 (h6) mm	Effektive Bearbeitungstiefe abhängig vom Konturwinkel (β) des Werkstückes. Effective machining depth depending on inclined angle (β) of workpiece.					
							0,5°	1°	1,5°	2°	2,5°	3°
	TA-X	mm	mm	mm	mm	mm						
0,2		0,16	0,5	0,18	45	4	1,08	1,26	1,43	1,6	1,77	1,95
0,2		0,16	1	0,18	45	4	1,51	1,77	2	2,22	2,43	2,62
0,2		0,16	1,5	0,18	45	4	1,91	2,29	2,57	2,82	3,06	3,28
0,3		0,24	1	0,28	45	4	1,57	1,81	2,03	2,23	2,43	2,63
0,3		0,24	1,5	0,28	45	4	1,99	2,32	2,59	2,84	3,06	3,28
0,3		0,24	2	0,28	45	4	2,39	2,83	3,15	3,43	3,68	3,92
0,4		0,3	1	0,37	45	4	1,71	1,91	2,11	2,3	2,49	2,68
0,4		0,3	1,5	0,37	45	4	2,15	2,42	2,67	2,9	3,12	3,32
0,4		0,3	2	0,37	45	4	2,58	2,94	3,23	3,48	3,73	3,95
0,4		0,3	2,5	0,37	45	4	3,01	3,45	3,78	4,07	4,33	4,57
0,4		0,3	3	0,37	45	4	3,41	3,96	4,33	4,64	4,92	5,19
0,5		0,4	2	0,45	45	4	2,79	3,08	3,34	3,58	3,81	4,02
0,5		0,4	3	0,45	45	4	3,69	4,1	4,43	4,72	4,99	5,25
0,5		0,4	4	0,45	45	4	4,56	5,12	5,52	5,86	6,16	6,44
0,5		0,4	5	0,45	45	4	5,37	6,14	6,6	6,98	7,31	7,62
0,5		0,4	6	0,45	45	4	5,52	7,16	7,67	8,09	8,45	8,78
0,5		0,4	8	0,45	45	4	5,52	9,19	9,81	10,29	10,7	11,07
0,6		0,5	2	0,55	45	4	2,83	3,11	3,36	3,59	3,81	4,03
0,6		0,5	3	0,55	45	4	3,73	4,13	4,45	4,73	5	5,25
0,6		0,5	4	0,55	45	4	4,61	5,14	5,53	5,86	6,16	6,44
0,6		0,5	5	0,55	45	4	5,45	6,16	6,61	6,98	7,31	7,62
0,6		0,5	6	0,55	45	4	5,91	7,18	7,68	8,09	8,45	8,78
0,6		0,5	8	0,55	45	4	5,91	9,21	9,82	10,3	10,7	11,07
0,8		0,6	2	0,75	45	4	2,9	3,15	3,39	3,61	3,83	4,03
0,8		0,6	4	0,75	45	4	4,7	5,19	5,56	5,88	6,18	6,45
0,8		0,6	5	0,75	45	4	5,58	6,21	6,64	7	7,32	7,62
0,8		0,6	6	0,75	45	4	6,41	7,22	7,71	8,11	8,46	8,78
0,8		0,6	7	0,75	45	4	6,68	8,24	8,78	9,21	9,59	9,93
0,8		0,6	8	0,75	45	4	6,68	9,25	9,85	10,31	10,71	11,07
0,8		0,6	10	0,75	45	4	6,68	11,29	11,97	12,49	12,93	13,33
1		0,8	3	0,95	45	4	3,88	4,22	4,51	4,77	5,02	5,26
1		0,8	4	0,95	45	4	4,79	5,23	5,59	5,9	6,19	6,45
1		0,8	5	0,95	45	4	5,68	6,25	6,66	7,02	7,33	7,63
1		0,8	6	0,95	45	4	6,55	7,26	7,73	8,13	8,47	8,79
1		0,8	7	0,95	45	4	7,35	8,28	8,8	9,23	9,6	9,94

Bestellbeispiel / Order example: 40-6080-0,2-0,5

Ø d1 (0/-0,01) mm	40-6080	l2 mm	l3 mm	Hals Ø d3 mm	l1 mm	Ø d2 (h6) mm	Effektive Bearbeitungstiefe abhängig vom Konturwinkel (β) des Werkstückes. Effective machining depth depending on inclined angle (β) of workpiece.					
							0,5°	1°	1,5°	2°	2,5°	3°
	TA-X	mm	mm	mm	mm	mm	mm	mm	mm	mm	mm	mm
1		0,8	8	0,95	45	4	7,46	9,3	9,87	10,32	10,72	11,08
1		0,8	9	0,95	45	4	7,46	10,31	10,93	11,42	11,83	12,21
1		0,8	10	0,95	45	4	7,46	11,33	11,99	12,5	12,94	13,33
1		0,8	12	0,95	45	4	7,46	13,36	14,11	14,67	15,14	15,57
1		0,8	14	0,95	50	4	7,46	15,38	16,21	16,82	17,33	17,78
1		0,8	16	0,95	50	4	7,46	17,41	18,31	18,97	19,51	19,98
1		0,8	20	0,95	55	4	7,46	21,47	22,5	23,23	23,83	24,34
1,2		1	6	1,15	45	4	6,65	7,3	7,76	8,14	8,48	8,79
1,2		1	8	1,15	45	4	8,29	9,33	9,89	10,34	10,73	11,08
1,2		1	10	1,15	45	4	8,23	11,36	12,01	12,52	12,95	13,34
1,2		1	12	1,15	45	4	8,23	13,39	14,12	14,68	15,15	15,57
1,4		1,1	8	1,35	45	4	8,47	9,37	9,91	10,35	10,74	11,08
1,4		1,1	12	1,35	45	4	9,01	13,43	14,14	14,69	15,16	15,57
1,4		1,1	16	1,35	50	4	9,01	17,48	18,35	18,99	19,52	19,99
1,5		1,2	8	1,45	45	4	8,54	9,39	9,92	10,36	10,74	11,09
1,5		1,2	12	1,45	45	4	9,39	13,45	14,15	14,7	15,16	15,57
1,5		1,2	16	1,45	50	4	9,39	17,5	18,36	18,99	19,52	19,99
1,5		1,2	20	1,45	55	4	9,39	21,55	22,54	23,25	23,84	24,35
1,6		1,3	8	1,55	45	4	8,59	9,41	9,93	10,36	10,74	11,09
1,6		1,3	12	1,55	45	4	9,78	13,46	14,16	14,7	15,16	15,58
1,6		1,3	16	1,55	50	4	9,78	17,52	18,37	19	19,52	19,99
1,6		1,3	20	1,55	55	4	9,78	21,57	22,55	23,26	23,84	—
1,8		1,4	8	1,75	45	4	8,69	9,45	9,96	10,38	10,75	11,09
1,8		1,4	12	1,75	45	4	10,56	13,5	14,18	14,71	15,17	15,58
1,8		1,4	16	1,75	50	4	10,56	17,55	18,38	19,01	19,53	19,99
1,8		1,4	20	1,75	55	4	10,56	21,6	22,57	23,27	23,85	—
2		1,6	6	1,95	45	4	6,95	7,45	7,85	8,2	8,52	8,81
2		1,6	8	1,95	45	4	8,77	9,48	9,98	10,39	10,76	11,1
2		1,6	10	1,95	45	4	10,53	11,51	12,09	12,57	12,98	13,35
2		1,6	12	1,95	45	4	11,33	13,53	14,2	14,73	15,18	15,58
2		1,6	14	1,95	50	4	11,33	15,56	16,3	16,88	17,36	17,8
2		1,6	16	1,95	50	4	11,33	17,58	18,4	19,02	19,54	19,99
2		1,6	18	1,95	55	4	11,33	19,61	20,49	21,15	21,7	—
2		1,6	20	1,95	55	4	11,33	21,63	22,58	23,28	23,85	—
2		1,6	22	1,95	60	4	11,33	23,65	24,67	25,4	—	—
2		1,6	25	1,95	65	4	11,33	26,69	27,79	28,57	—	—
2		1,6	30	1,95	70	4	11,33	31,74	32,98	—	—	—
3		2,4	8	2,85	50	6	9,5	9,95	10,33	10,67	10,99	11,29
3		2,4	10	2,85	50	6	11,4	11,96	12,42	12,83	13,19	13,53
3		2,4	16	2,85	55	6	17,03	18,02	18,69	19,23	19,71	20,13
3		2,4	20	2,85	60	6	20,67	22,06	22,85	23,47	24,01	24,48
3		2,4	25	2,85	65	6	22,37	27,1	28,03	28,75	29,34	29,86
3		2,4	30	2,85	70	6	22,37	32,15	33,21	34	34,65	—
3		2,4	35	2,85	80	6	22,37	37,19	38,37	39,23	—	—
4		3,2	10	3,85	60	6	11,59	12,08	12,5	12,88	13,22	13,54
4		3,2	16	3,85	60	6	17,28	18,14	18,76	19,28	19,73	20,15
4		3,2	20	3,85	65	6	21,02	22,17	22,91	23,51	24,03	—
4		3,2	25	3,85	70	6	25,51	27,21	28,1	28,78	—	—
4		3,2	30	3,85	80	6	26,24	32,25	33,27	—	—	—
4		3,2	35	3,85	80	6	26,24	37,3	38,42	—	—	—
4		3,2	40	3,85	90	6	26,24	42,33	—	—	—	—
4		3,2	45	3,85	90	6	26,24	47,37	—	—	—	—
4		3,2	50	3,85	100	6	26,24	52,41	—	—	—	—
5		4	20	4,85	70	6	21,28	22,28	—	—	—	—
5		4	25	4,85	70	6	25,94	27,32	—	—	—	—

Bestellbeispiel / Order example: 40-6080-1-8

Ø d1 (0/-0,01) mm	40-6080	l2 mm	l3 mm	Hals Ø d3 mm	l1 mm	Ø d2 (h6) mm	Effektive Bearbeitungstiefe abhängig vom Konturwinkel (β) des Werkstückes. <i>Effective machining depth depending on inclined angle (β) of workpiece.</i>					
	TA-X						0,5°	1°	1,5°	2°	2,5°	3°
5		4	30	4,85	80	6	30,24	—	—	—	—	—
5		4	35	4,85	80	6	30,12	—	—	—	—	—
6		4,8	30	5,85	80	8	30,84	32,46	33,38	—	—	—
6		4,8	50	5,85	120	8	33,99	52,6	—	—	—	—

Bestellbeispiel / Order example: 40-6080-5-30

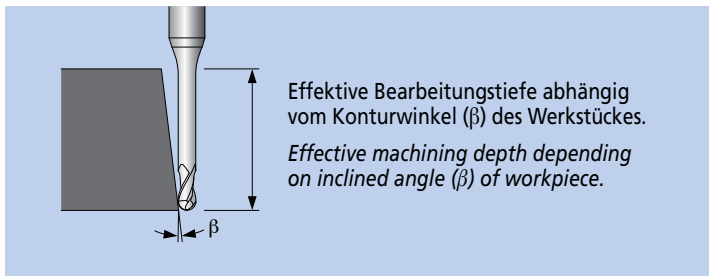

HAM 40-6090

Vollhartmetall-Radiusfräser solid carbide ball nose end mill

W+F VHM Z 2 30° rechts Werk Norm
Typ H HA
HSF HSC SHRINK FIT

- Konstruktions-Daten**
- langer Hals zum Rippenfräsen
 - zylindrischer Hals
 - extrem verstärkter Kern
 - Radiusform-Toleranz 0,01

- Engineering data**
- long neck for rib milling
 - cylindrical neck
 - strongly reinforced web thickness
 - radius form tolerance 0,01

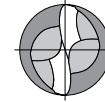
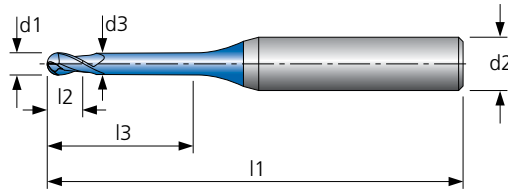

Material	Alu Knet-leg.	Alu Guss-leg.	Stahl < 800 N/mm²	Stahl < 1200 N/mm²	Stahl < 1600 N/mm²	Stahl < 55 HRC	Stahl < 60 HRC	Stahl < 66 HRC	INOX < 800 N/mm²	INOX > 800 N/mm²	GG	GGG	hochw. Legierungen	Titan	NE-Metalle Cu-Leg.	Graphit & Faserverbund	MMS	max.	ohne	AIR
40-6090			●	●	●	●	●		○	○	●	●					●		●	●

Schnittdaten siehe Seite / cutting data available on page – 222

● sehr gut geeignet / very suitable ○ bedingt geeignet / limited suitable

Ø d1 (0/-0,01) mm	40-6090	l2	l3	Hals Ø d3	l1	Ø d2 (h6) mm	Effektive Bearbeitungstiefe abhängig vom Konturwinkel (β) des Werkstückes. Effective machining depth depending on inclined angle (β) of workpiece.					
							0,5°	1°	1,5°	2°	2,5°	3°
	TA-X	mm	mm	mm	mm	mm						
0,2		0,16	0,5	0,18	45	4	1,11	1,28	1,45	1,62	1,79	1,96
0,2		0,16	1	0,18	45	4	1,69	1,91	2,12	2,32	2,52	2,71
0,2		0,16	1,5	0,18	45	4	2,26	2,52	2,76	2,98	3,2	3,41
0,3		0,24	1	0,28	45	4	1,68	1,9	2,1	2,3	2,5	2,68
0,3		0,24	1,5	0,28	45	4	2,25	2,51	2,75	2,97	3,18	3,39
0,3		0,24	2	0,28	45	4	2,81	3,11	3,37	3,61	3,84	4,06
0,4		0,3	1	0,37	45	4	1,76	1,95	2,15	2,34	2,52	2,7
0,4		0,3	1,5	0,37	45	4	2,32	2,56	2,78	3	3,2	3,4
0,4		0,3	2	0,37	45	4	2,87	3,15	3,4	3,64	3,86	4,08
0,4		0,3	2,5	0,37	45	4	3,43	3,74	4,01	4,26	4,5	4,73
0,4		0,3	3	0,37	45	4	3,98	4,31	4,61	4,88	5,13	5,38
0,5		0,4	2	0,45	45	4	2,99	3,24	3,48	3,7	3,91	4,12
0,5		0,4	3	0,45	45	4	4,08	4,39	4,67	4,93	5,18	5,41
0,5		0,4	4	0,45	45	4	5,16	5,53	5,84	6,13	6,41	6,66
0,5		0,4	5	0,45	45	4	6,24	6,65	7	7,32	7,61	7,88
0,5		0,4	6	0,45	45	4	7,31	7,76	8,14	8,48	8,79	9,09
0,5		0,4	8	0,45	45	4	9,45	9,96	10,39	10,77	11,12	11,44
0,6		0,5	2	0,55	45	4	2,98	3,23	3,46	3,69	3,9	4,11
0,6		0,5	3	0,55	45	4	4,07	4,38	4,66	4,92	5,17	5,4
0,6		0,5	4	0,55	45	4	5,16	5,52	5,84	6,13	6,4	6,65
0,6		0,5	5	0,55	45	4	6,24	6,64	6,99	7,31	7,6	7,87
0,6		0,5	6	0,55	45	4	7,31	7,75	8,13	8,47	8,78	9,08
0,6		0,5	8	0,55	45	4	9,44	9,96	10,39	10,77	11,11	11,44
0,8		0,6	2	0,75	45	4	2,97	3,22	3,44	3,66	3,87	4,07
0,8		0,6	4	0,75	45	4	5,15	5,51	5,82	6,11	6,37	6,63
0,8		0,6	5	0,75	45	4	6,23	6,63	6,98	7,29	7,58	7,85
0,8		0,6	6	0,75	45	4	7,3	7,74	8,12	8,46	8,77	9,06
0,8		0,6	7	0,75	45	4	8,37	8,85	9,25	9,61	9,94	10,24
0,8		0,6	8	0,75	45	4	9,44	9,95	10,38	10,75	11,1	11,42
0,8		0,6	10	0,75	45	4	11,56	12,13	12,6	13,02	13,39	13,74
1		0,8	3	0,95	45	4	4,06	4,36	4,63	4,88	5,12	5,35
1		0,8	4	0,95	45	4	5,14	5,49	5,8	6,09	6,35	6,6
1		0,8	5	0,95	45	4	6,22	6,62	6,96	7,27	7,56	7,83
1		0,8	6	0,95	45	4	7,3	7,73	8,11	8,44	8,75	9,04
1		0,8	7	0,95	45	4	8,37	8,84	9,24	9,6	9,92	10,23

Bestellbeispiel / Order example: 40-6090-0,2-0,5

Ø d1 (0/-0,01) mm	40-6090	l2	l3	Hals Ø d3	l1	Ø d2 (h6) mm	Effektive Bearbeitungstiefe abhängig vom Konturwinkel (β) des Werkstückes. Effective machining depth depending on inclined angle (β) of workpiece.						
							TA-X	mm	mm	mm	mm	mm	0,5°
	1		0,8	8	0,95	45	4		9,43	9,94	10,36	10,74	11,08
1		0,8	9	0,95	45	4		10,49	11,03	11,48	11,88	12,23	12,57
1		0,8	10	0,95	45	4		11,55	12,12	12,59	13	13,38	13,72
1		0,8	12	0,95	45	4		13,67	14,29	14,8	15,24	15,64	16,01
1		0,8	14	0,95	50	4		15,77	16,44	16,99	17,46	17,88	18,27
1		0,8	16	0,95	50	4		17,87	18,59	19,16	19,66	20,1	20,51
1		0,8	20	0,95	55	4		22,05	22,85	23,48	24,03	24,51	24,94
1,2		1	6	1,15	45	4		7,29	7,72	8,09	8,42	8,73	9,02
1,2		1	8	1,15	45	4		9,42	9,93	10,35	10,73	11,07	11,38
1,2		1	10	1,15	45	4		11,55	12,11	12,58	12,99	13,36	13,71
1,2		1	12	1,15	45	4		13,66	14,28	14,79	15,23	15,63	15,99
1,4		1,1	8	1,35	45	4		9,42	9,92	10,34	10,71	11,05	11,37
1,4		1,1	12	1,35	45	4		13,66	14,27	14,78	15,22	15,61	15,98
1,4		1,1	16	1,35	50	4		17,86	18,57	19,15	19,64	20,08	20,48
1,5		1,2	8	1,45	45	4		9,42	9,91	10,33	10,7	11,04	11,36
1,5		1,2	12	1,45	45	4		13,65	14,27	14,77	15,21	15,61	15,97
1,5		1,2	16	1,45	50	4		17,86	18,57	19,14	19,64	20,08	20,48
1,5		1,2	20	1,45	55	4		22,04	22,84	23,47	24,01	24,48	—
1,6		1,3	8	1,55	45	4		9,41	9,91	10,33	10,7	11,04	11,35
1,6		1,3	12	1,55	45	4		13,65	14,27	14,77	15,21	15,6	15,97
1,6		1,3	16	1,55	50	4		17,86	18,57	19,14	19,63	20,07	20,47
1,6		1,3	20	1,55	55	4		22,04	22,83	23,46	24	24,48	—
1,8		1,4	8	1,75	45	4		9,41	9,9	10,31	10,68	11,02	11,33
1,8		1,4	12	1,75	45	4		13,64	14,26	14,76	15,2	15,59	15,95
1,8		1,4	16	1,75	50	4		17,85	18,56	19,13	19,62	20,06	20,46
1,8		1,4	20	1,75	55	4		22,04	22,83	23,45	23,99	24,47	—
2		1,6	6	1,95	45	4		7,26	7,68	8,03	8,36	8,66	8,94
2		1,6	8	1,95	45	4		9,4	9,89	10,3	10,67	11	11,32
2		1,6	10	1,95	45	4		11,52	12,08	12,54	12,94	13,31	13,64
2		1,6	12	1,95	45	4		13,64	14,25	14,75	15,18	15,58	15,94
2		1,6	14	1,95	50	4		15,75	16,41	16,94	17,41	17,82	18,2
2		1,6	16	1,95	50	4		17,85	18,55	19,12	19,61	20,05	—
2		1,6	18	1,95	55	4		19,94	20,69	21,29	21,8	22,26	—
2		1,6	20	1,95	55	4		22,03	22,82	23,45	23,98	—	—
2		1,6	22	1,95	60	4		24,12	24,94	25,6	26,15	—	—
2		1,6	25	1,95	65	4		27,24	28,12	28,81	29,39	—	—
2		1,6	30	1,95	70	4		32,43	33,38	34,13	—	—	—
3		2,4	8	2,85	50	6		9,71	10,11	10,47	10,8	11,11	11,39
3		2,4	10	2,85	50	6		11,81	12,28	12,69	13,06	13,4	13,71
3		2,4	16	2,85	55	6		18,08	18,71	19,24	19,7	20,12	20,5
3		2,4	20	2,85	60	6		22,25	22,97	23,55	24,06	24,52	24,94
3		2,4	25	2,85	65	6		27,44	28,25	28,9	29,46	29,96	—
3		2,4	30	2,85	70	6		32,61	33,5	34,21	34,82	35,35	—
3		2,4	35	2,85	80	6		37,77	38,74	39,5	40,14	—	—
4		3,2	10	3,85	60	6		11,78	12,24	12,64	12,99	13,33	13,64
4		3,2	16	3,85	60	6		18,06	18,68	19,2	19,65	20,07	20,44
4		3,2	20	3,85	65	6		22,23	22,94	23,52	24,02	24,47	—
4		3,2	25	3,85	70	6		27,42	28,22	28,87	29,43	—	—
4		3,2	30	3,85	80	6		32,59	33,48	34,18	—	—	—
4		3,2	35	3,85	80	6		37,76	38,72	39,47	—	—	—
4		3,2	40	3,85	90	6		42,91	43,94	—	—	—	—
4		3,2	45	3,85	90	6		48,05	49,14	—	—	—	—
4		3,2	50	3,85	100	6		53,19	54,34	—	—	—	—
5		4	20	4,85	70	6		22,21	22,9	—	—	—	—
5		4	25	4,85	70	6		27,4	28,19	—	—	—	—

Bestellbeispiel / Order example: 40-6090-1-8

Ø d1 (0/-0,01) mm	40-6090	l2 mm	l3 mm	Hals Ø d3 mm	l1 mm	Ø d2 (h6) mm	Effektive Bearbeitungstiefe abhängig vom Konturwinkel (β) des Werkstückes. <i>Effective machining depth depending on inclined angle (β) of workpiece.</i>					
	TA-X						0,5°	1°	1,5°	2°	2,5°	3°
5		4	30	4,85	80	6	32,58	—	—	—	—	—
5		4	35	4,85	80	6	37,74	—	—	—	—	—
6		4,8	30	5,85	80	8	32,56	33,43	34,12	—	—	—
6		4,8	50	5,85	120	8	53,16	54,3	—	—	—	—

Bestellbeispiel / Order example: 40-6090-5-30

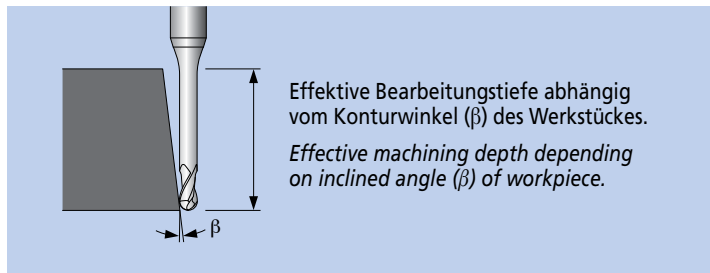

HAM 40-5670

Vollhartmetall-Radiusfräser solid carbide ball nose end mill

W+F VHM Z 2 30° rechts Werk Norm
Typ N DIN 6535 HA
SHRINK FIT
DIN 6535 HB

Konstruktions-Daten

- universell einsetzbar
- verstärkter Kern
- zentrumsschneidend
- Radiusform-Toleranz 0,02

Engineering data

- allround end mill
- reinforced web thickness
- centre cutting
- radius form tolerance 0,02

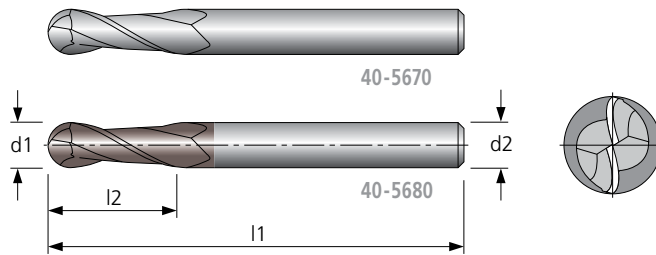

Material	Alu Knet-leg.	Alu Guss-leg.	Stahl < 800 N/mm²	Stahl < 1200 N/mm²	Stahl < 1600 N/mm²	Stahl < 55 HRC	Stahl < 60 HRC	Stahl < 66 HRC	INOX < 800 N/mm²	INOX > 800 N/mm²	GG	GGG	hochw. Legierungen	Titan	NE-Metalle Cu-Leg.	Graphit & Faser-verbund	MMS	max.	ohne	AIR
40-5670	○	○	●	○	○	○			○	○	●	○			○		●	○	○	●
40-5680			●	●	●	○			○	○	●	●					●	○	○	●

Schnittdaten siehe Seite / cutting data available on page – 224

● sehr gut geeignet / very suitable ○ bedingt geeignet / limited suitable

Ø d1 (f8) mm	40-5670	40-5680	l2 mm	l1 mm	Ø d2 (h6) mm	Ø d1 (f8) mm	40-5670	40-5680	l2 mm	l1 mm	Ø d2 (h6) mm
		TA						TA			
0,4			2	38	3	2			3	50	6
0,4			3	38	3	2			7	57	6
0,5			2	38	3	2,5			3	50	6
0,5			3	38	3	2,5			7	57	6
0,5			3	38	4	3			4	50	6
0,6			2	38	3	3			7	57	6
0,6			3	38	3	4			8	57	6
0,6			3	38	4	5			10	57	6
0,8			2	38	3	6			10	57	6
0,8			3	38	3	8			16	63	8
0,8			3	38	4	10			19	72	10
1			3	38	3	12			22	83	12
1			5	38	3	14			22	83	14
1			5	38	4	16			26	92	16
1,5			3	38	3	18			26	92	18
1,5			5	38	3	20			32	104	20
1,5			5	38	4						

Bestellbeispiel / Order example: HA-Schaft / shank 40-5670-2-3-6
HB-Schaft / shank 40-5670-2-3-6-HB

HAM 40-5710

Vollhartmetall-Radiusfräser solid carbide ball nose end mill

W+F VHM Z 2 30° rechts Werk Norm

Typ N 3D-Diagramm DIN 6535 HA

SHRINK FIT

DIN 6535 HB

Konstruktions-Daten

- universell einsetzbar
- verstärkter Kern
- zentrumsschneidend
- Radiusform-Toleranz 0,02

Engineering data

- allround end mill
- reinforced web thickness
- centre cutting
- radius form tolerance 0,02

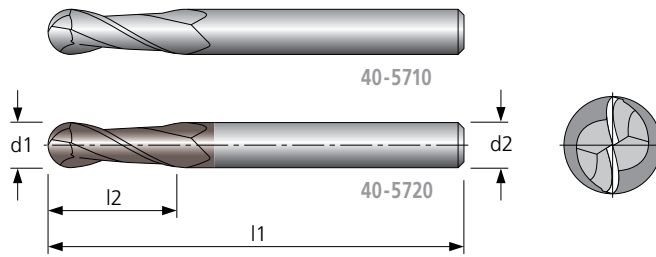

Material	Alu Knet-leg.	Alu Guss-leg.	Stahl < 800 N/mm²	Stahl < 1200 N/mm²	Stahl < 1600 N/mm²	Stahl < 55 HRC	Stahl < 60 HRC	Stahl < 66 HRC	INOX < 800 N/mm²	INOX > 800 N/mm²	GG	GGG	hochw. Legierungen	Titan	NE-Metalle Cu-Leg.	Graphit & Faser-verbund	MMS	max.	ohne	AIR
40-5710	○	○	●	○	○	○			○	○	●	○			○		●	○	○	●
40-5720			●	●	●	○			○	○	●	●					●	○	○	●

Schnittdaten siehe Seite / cutting data available on page – 224

● sehr gut geeignet / very suitable ○ bedingt geeignet / limited suitable

Ø d1 (f8) mm	40-5710	40-5720	l2 mm	l1 mm	Ø d2 (h6) mm
	TA				
4			12	70	6
5			15	80	6
6			15	80	6
8			20	90	8
10			25	100	10

Ø d1 (f8) mm	40-5710	40-5720	l2 mm	l1 mm	Ø d2 (h6) mm
	TA				
12			30	110	12
16			40	120	16
18			40	130	20
20			45	130	20

Bestellbeispiel / Order example: HA-Schaft / shank 40-5710-12-30-12
HB-Schaft / shank 40-5710-12-30-12-HB

HAM 40-5760

Vollhartmetall-Radiusfräser solid carbide ball nose end mill

W+F

VHM

Z 2

30° rechts

Werk Norm

Typ H

DIN 6535 HA

HSC

SHRINK FIT

DIN 6535 HB

- Konstruktions-Daten**
- zum Hartfräsen bis 65 HRC
 - zentrumsschneidend
 - verstärkter Kern
 - Radiusform-Toleranz 0,02

- Engineering data**
- for hard milling up to 65 HRC
 - centre cutting
 - reinforced web thickness
 - radius form tolerance 0,02

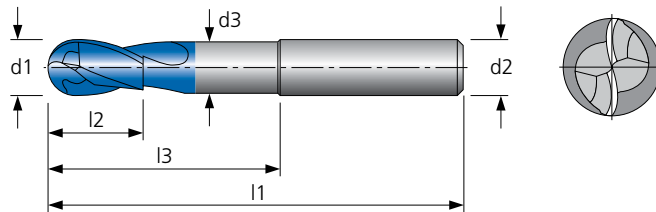

Material	Alu Knet-leg.	Alu Guss-leg.	Stahl < 800 N/mm²	Stahl < 1200 N/mm²	Stahl < 1600 N/mm²	Stahl < 55 HRC	Stahl < 60 HRC	Stahl < 66 HRC	INOX < 800 N/mm²	INOX > 800 N/mm²	GG	GGG	hochw. Legierungen	Titan	NE-Metalle Cu-Leg.	Graphit & Faser-verbund	MMS	max.	ohne	AIR
40-5760			○	●	●	●	●	○	○	○	●	●	○	○			●	○	●	●

Schnittdaten siehe Seite / cutting data available on page – 225

● sehr gut geeignet / very suitable ○ bedingt geeignet / limited suitable

Ø d1 (f8) mm	40-5760						Ø d1 (f8) mm	40-5760					
	TA-X	l2 mm	l3 mm	Hals Ø d3 mm	l1 mm	Ø d2 (h6) mm		TA-X	l2 mm	l3 mm	Hals Ø d3 mm	l1 mm	Ø d2 (h6) mm
0,4		0,6	1	0,38	38	3	5	5	32	4,8	70	6	
0,5		0,75	1,3	0,48	38	3	5	5	42	4,8	80	6	
0,6		0,9	1,5	0,57	38	3	5	5	52	4,8	90	6	
0,8		1,2	2	0,76	38	3	6	6	21	5,7	57	6	
1		1,5	2,5	0,95	38	3	6	6	34	5,7	70	6	
1,2		1,6	2,8	1,14	38	3	6	6	44	5,7	80	6	
1,5		2	3,5	1,43	38	3	6	6	64	5,7	100	6	
2		2,2	4,2	1,9	38	3	8	8	27	7,6	63	8	
2,5		2,5	5	2,38	38	3	8	8	64	7,6	100	8	
3		3	6	2,9	57	6	8	8	84	7,6	120	8	
3		3	22	2,9	50	3	10	10	32	9,5	72	10	
4		4	8	3,85	57	6	10	10	80	9,5	120	10	
4		4	26	3,9	54	4	10	10	100	9,5	140	10	
4		4	30	3,85	70	6	12	12	38	11,4	83	12	
4		4	40	3,85	80	6	12	12	75	11,4	120	12	
4		4	50	3,85	90	6	12	12	105	11,4	150	12	
5		5	10	4,8	57	6	16	16	112	15,4	160	16	
5		5	26	4,8	54	5							

Bestellbeispiel / Order example: HA-Schaft/shank 40-5760-5-32
HB-Schaft/shank 40-5760-5-32-HB

HAM 40-5920

Vollhartmetall-Radiuskopierfräser
solid carbide ball nose end mill

W+F VHM Z 3 30° rechts Werk Norm
Typ H HA SHRINK FIT HB

Konstruktions-Daten

- Spanwinkel negativ
- zentrumsschneidend
- verstärkter Kern
- Radiusform-Toleranz 0,02

Engineering data

- rake angle negative
- centre cutting
- reinforced web thickness
- radius form tolerance 0,02

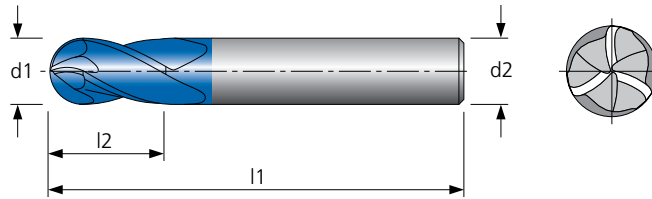

Material	Alu Knet-leg.	Alu Guss-leg.	Stahl < 800 N/mm²	Stahl < 1200 N/mm²	Stahl < 1600 N/mm²	Stahl < 55 HRC	Stahl < 60 HRC	Stahl < 66 HRC	INOX < 800 N/mm²	INOX > 800 N/mm²	GG	GGG	hochw. Legierungen	Titan	NE-Metalle Cu-Leg.	Graphit & Faser-verbund	MMS	max.	ohne	AIR
40-5920					○	●	●	●			●	●					●	○	●	●

Schnittdaten siehe Seite / cutting data available on page – 227

● sehr gut geeignet / very suitable ○ bedingt geeignet / limited suitable

Ø d1 (f8) mm	40-5920	l2 mm	l1 mm	Ø d2 (h6) mm
	TA-X			
2		5	50	6
3		8	60	6
4		8	70	6
5		10	80	6
6		12	90	6

Ø d1 (f8) mm	40-5920	l2 mm	l1 mm	Ø d2 (h6) mm
	TA-X			
8		14	100	8
10		18	100	10
12		22	110	12
16		30	140	16
20		38	160	20

Bestellbeispiel / Order example: HA-Schaft/shank 40-5920-8
HB-Schaft/shank 40-5920-8-HB

HAM 40-5981

Vollhartmetall-Radiuskopierfräser
solid carbide ball nose end mill

W+F VHM Z 4 30° rechts Werk Norm
Typ H DIN 6535 HA
HSC SHRINK FIT
DIN 6535 HB

Konstruktions-Daten

- zentrumsschneidend
- verstärkter Kern
- universell einsetzbar
- Radiusform-Toleranz 0,02

Engineering data

- centre cutting
- reinforced web thickness
- allround end mill
- radius form tolerance 0,02

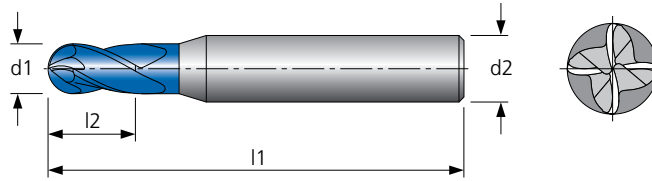

Material	Alu Knet-leg.	Alu Guss-leg.	Stahl < 800 N/mm²	Stahl < 1200 N/mm²	Stahl < 1600 N/mm²	Stahl < 55 HRC	Stahl < 60 HRC	Stahl < 66 HRC	INOX < 800 N/mm²	INOX > 800 N/mm²	GG	GGG	hochw. Legierungen	Titan	NE-Metalle Cu-Leg.	Graphit & Faser-verbund	MMS	max.	ohne	AIR
40-5981			●	●	●	●	○		○	○	●	●					●	○	●	●

Schnittdaten siehe Seite / cutting data available on page – 228

● sehr gut geeignet / very suitable ○ bedingt geeignet / limited suitable

Ø d1 (f8) mm	40-5981	l2 mm	l1 mm	Ø d2 (h6) mm
	TA-X			
3		8	57	6
4		11	57	6
4		12	70	6
5		13	57	6
6		13	57	6
6		15	80	6
8		19	63	8
8		20	90	8
10		22	72	10

Ø d1 (f8) mm	40-5981	l2 mm	l1 mm	Ø d2 (h6) mm
	TA-X			
10		25	100	10
12		26	83	12
12		30	110	12
14		26	83	14
16		32	92	16
16		40	120	16
20		38	104	20
20		45	130	20

Bestellbeispiel / Order example: HA-Schaft/shank 40-5981-10-25
HB-Schaft/shank 40-5981-10-25-HB

HAM 40-5800

Vollhartmetall-Radiusfräser solid carbide ball nose end mill

W+F VHM Z 2 15° rechts Werk Norm
Typ H HA
HSF HSC SHRINK FIT
HB

Konstruktions-Daten

- zentrumsschneidend
- zum Fräsen von kleinen Hinterschnitten geeignet
- Radiusform-Toleranz 0,02

Engineering data

- centre cutting
- undercut machining
- radius form tolerance 0,02

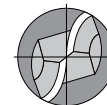
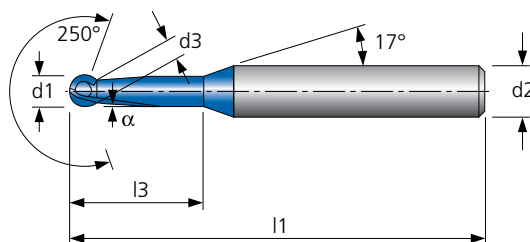

Material	Alu Knet-leg.	Alu Guss-leg.	Stahl < 800 N/mm²	Stahl < 1200 N/mm²	Stahl < 1600 N/mm²	Stahl < 55 HRC	Stahl < 60 HRC	Stahl < 66 HRC	INOX < 800 N/mm²	INOX > 800 N/mm²	GG	GGG	hochw. Legierungen	Titan	NE-Metalle Cu-Leg.	Graphit & Faser-verbund	MMS	max.	ohne	AIR
40-5800			○	●	●	●	○		○	○	●	●					●		●	●

Schnittdaten siehe Seite / cutting data available on page – 229

● sehr gut geeignet / very suitable ○ bedingt geeignet / limited suitable

Ø d1 (f8) mm	40-5800	α	l3 mm	Hals Ø d3 mm	l1 mm	Ø d2 (h6) mm
	TA-X					
1		1,5°	20	0,7	80	6
2		1,5°	20	1,4	80	6
3		1,5°	30	2,1	80	6
4		3°	30	3,3	80	6

Ø d1 (f8) mm	40-5800	α	l3 mm	Hals Ø d3 mm	l1 mm	Ø d2 (h6) mm
	TA-X					
5		1°	40	4,1	90	6
6		—	45	4,7	100	6
8		1°	45	6,5	100	8
10		1°	55	8,2	100	10

Bestellbeispiel / Order example: HA-Schaft/shank 40-5800-5
HB-Schaft/shank 40-5800-5-HB

Diamant-Werkzeuge

diamond tools

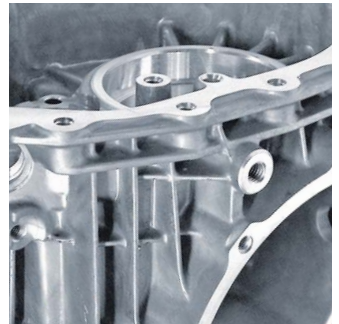

Sie profitieren von unserem langjährigen Know-how bei der Entwicklung und Herstellung von kundenspezifischen PKD-Werkzeugen.

Des Weiteren bieten wir Ihnen einen umfangreichen Nachschärf-service und das Instandsetzen von PKD-Werkzeugen an.

Vorteile:

- Hohe Schnittgeschwindigkeiten
- Hohe Standzeiten
- Hohe Oberflächengüte

You benefit from our long-standing know-how in the development and manufacturing of customer-specific PCD tools.

Furthermore we offer you a comprehensive re-sharpening service and the maintenance of PCD tools.

Advantages:

- High cutting speeds
- High tool life
- High surface quality

Für weitere Informationen stehen wir Ihnen gerne zur Verfügung.
For further information please do not hesitate to contact us.

Spezialfräser

special milling tools



Vollhartmetall-Spezialfräser
zum Gravieren, Entgraten und Fasen.

*Solid carbide special milling tools
for engraving, deburring and chamfering.*

HAM 40-1880

Vollhartmetall-Gravierstichel
solid carbide engraving bits

VHM Z 1 0° Nut Werk Norm
Typ N HA
SHRINK FIT

- Konstruktions-Daten**
- zentrumsschneidend
 - spezielles Werkzeug zum Gravieren und Kopieren

- Engineering data**
- centre cutting
 - special tool for engraving and copying

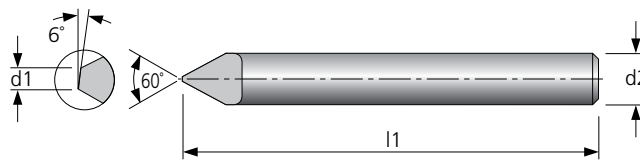

Andere Spitzenwinkel auf Anfrage
Different cutting angles on request

Material	Alu Knet-leg.	Alu Guss-leg.	Stahl < 800 N/mm²	Stahl < 1200 N/mm²	Stahl < 1600 N/mm²	Stahl < 55 HRC	Stahl < 60 HRC	Stahl < 66 HRC	INOX < 800 N/mm²	INOX > 800 N/mm²	GG	GGG	hochw. Legierungen	Titan	NE-Metalle Cu-Leg.	Graphit & Faser-verbund	MMS	max.	ohne	AIR
40-1880	●	●	●	●	●						●	●			●	○	●	○	●	●

Schnittdaten siehe Seite / cutting data available on page – 230

● sehr gut geeignet / very suitable ○ bedingt geeignet / limited suitable

Ø d1 mm	40-1880	l2 mm	l1 mm	Ø d2 (h6) mm
0,2		3	40	2
0,2		3	50	3
0,2		4	60	4
0,2		5	60	5
0,2		6	75	6

Ø d1 mm	40-1880	l2 mm	l1 mm	Ø d2 (h6) mm
0,25		8	90	8
0,25		10	100	10

Bestellbeispiel / Order example: 40-1880-0,25-8-90

HAM 40-1921

Vollhartmetall-Entgrat- und Fasfräser solid carbide deburring and chamfering mill

VHM Z 4 8° rechts Werk Norm
Typ N DIN 6535 HA
90° SHRINK FIT
DIN 6535 HB

Konstruktions-Daten
 • zum Anfasen und Entgraten
Engineering data
 • for chamfering and deburring

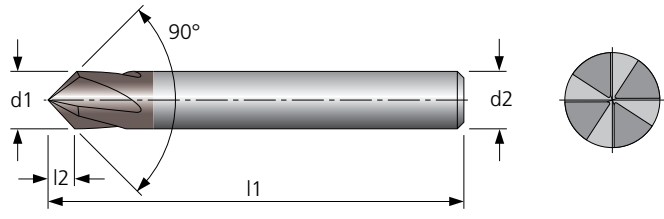

Material	Alu Knet-leg.	Alu Guss-leg.	Stahl < 800 N/mm²	Stahl < 1200 N/mm²	Stahl < 1600 N/mm²	Stahl < 55 HRC	Stahl < 60 HRC	Stahl < 66 HRC	INOX < 800 N/mm²	INOX > 800 N/mm²	GG	GGG	hochw. Legierungen	Titan	NE-Metalle Cu-Leg.	Graphit & Faser-verbund	MMS	max.	ohne	AIR
40-1921	●	●	●	●	●	○			●	●	●	●	○	○	●	○	●	●	●	●

Schnittdaten siehe Seite / cutting data available on page – 231

● sehr gut geeignet / very suitable ○ bedingt geeignet / limited suitable

Ø d1 (h7) mm	40-1921	l2 mm	l1 mm	Ø d2 (h6) mm
	TA			
4		1,8	54	4
6		2,8	57	6
8		3,8	63	8
10		4,8	72	10

Ø d1 (h7) mm	40-1921	l2 mm	l1 mm	Ø d2 (h6) mm
	TA			
12		5,8	83	12
16		7,8	92	16
20		9,8	104	20

Bestellbeispiel / Order example: HA-Schaft/shank 40-1921-12
 HB-Schaft/shank 40-1921-12-HB

HAM 40-1961

Vollhartmetall-Entgrat- und Fasfräser solid carbide deburring and chamfering mill

VHM Z 4 8° rechts Werk Norm
 Typ N 8° rechts DIN 6535 HA
 60° SHRINK FIT
 DIN 6535 HB

- Konstruktions-Daten**
 • zum Anfasen und Entgraten
- Engineering data**
 • for chamfering and deburring

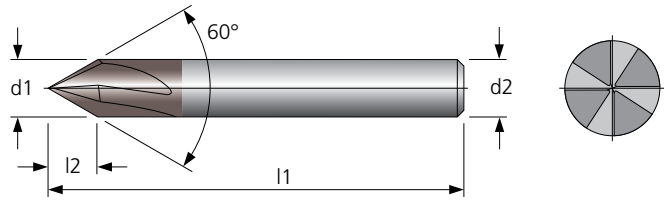

Material	Alu Knet-leg.	Alu Guss-leg.	Stahl < 800 N/mm²	Stahl < 1200 N/mm²	Stahl < 1600 N/mm²	Stahl < 55 HRC	Stahl < 60 HRC	Stahl < 66 HRC	INOX < 800 N/mm²	INOX > 800 N/mm²	GG	GGG	hochw. Legierungen	Titan	NE-Metalle Cu-Leg.	Graphit & Faser-verbund	MMS	max.	ohne	AIR
40-1961	●	●	●	●	●	○			●	●	●	●	○	○	●	○	●	●	●	●

Schnittdaten siehe Seite / cutting data available on page – 232

● sehr gut geeignet / very suitable ○ bedingt geeignet / limited suitable

Ø d1 (h7) mm	40-1961	l2 mm	l1 mm	Ø d2 (h6) mm
	TA			
4		3,3	54	4
6		5,0	57	6
8		6,8	63	8

Ø d1 (h7) mm	40-1961	l2 mm	l1 mm	Ø d2 (h6) mm
	TA			
10		8,5	72	10
12		10,0	83	12

Bestellbeispiel / Order example: HA-Schaft/shank 40-1961-10
 HB-Schaft/shank 40-1961-10-HB

HAM 40-2001

Vollhartmetall-Viertelkreisfräser konkav solid carbide corner-rounding concave cutter

VHM Z 4 0° Nut Werk Norm
Typ N HA
SHRINK FIT
HB

- Konstruktions-Daten**
- zum Verrunden von Kanten
- Engineering data**
- especially for chamfering

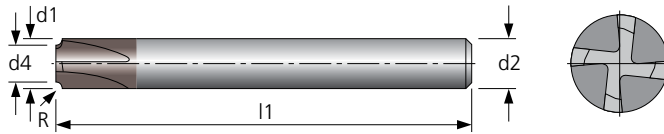

Material	Alu Knet-leg.	Alu Guss-leg.	Stahl < 800 N/mm²	Stahl < 1200 N/mm²	Stahl < 1600 N/mm²	Stahl < 55 HRC	Stahl < 60 HRC	Stahl < 66 HRC	INOX < 800 N/mm²	INOX > 800 N/mm²	GG	GGG	hochw. Legierungen	Titan	NE-Metalle Cu-Leg.	Graphit & Faser-verbund	MMS	max.	ohne	AIR
40-2001	●	●	●	●	●	○			●	●	●	●	○	○	●	○	●	●	●	●

Schnittdaten siehe Seite / cutting data available on page – 233

● sehr gut geeignet / very suitable ○ bedingt geeignet / limited suitable

Ø d1 mm	40-2001	l2 mm	l1 mm	r ± 0,05 mm	Ø d4 - 0,1 mm	Ø d2 (h6) mm
	TA					
6		9	70	0,5	5	6
8		12	70	1	6	8
8		12	75	1,5	5	8
10		15	75	2	6	10
10		15	75	2,5	5	10

Ø d1 mm	40-2001	l2 mm	l1 mm	r ± 0,05 mm	Ø d4 - 0,1 mm	Ø d2 (h6) mm
	TA					
12		18	75	3	6	12
12		18	80	3,5	5	12
16		24	80	4	8	16
16		24	80	5	6	16
20		30	80	6	8	20

Bestellbeispiel / Order example: HA-Schaft/shank 40-2001-12-3
HB-Schaft/shank 40-2001-12-3-HB

HAM 40-2041

Vollhartmetall-Entgrat- und Fasfräser solid carbide deburring and chamfering mill

VHM
Z 4
0° Nut
Werk Norm

Typ N
HA

SHRINK FIT

HB

- Konstruktions-Daten**
- Vor- und Rückwärtsbearbeitung
- Engineering data**
- forward- and backward chamfering

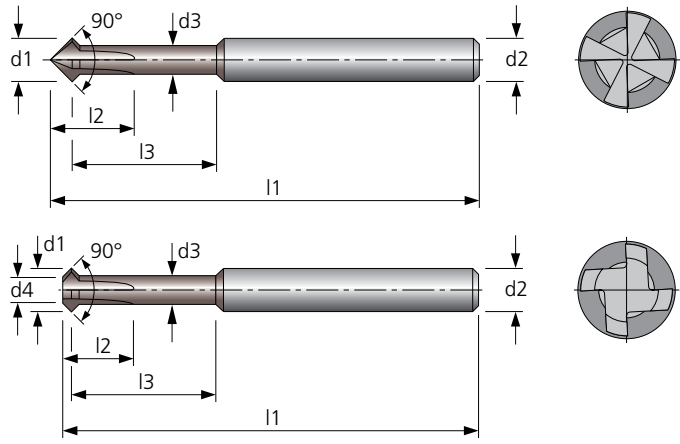

Material	Alu Knet-leg.	Alu Guss-leg.	Stahl < 800 N/mm²	Stahl < 1200 N/mm²	Stahl < 1600 N/mm²	Stahl < 55 HRC	Stahl < 60 HRC	Stahl < 66 HRC	INOX < 800 N/mm²	INOX > 800 N/mm²	GG	GGG	hochw. Legierungen	Titan	NE-Metalle Cu-Leg.	Graphit & Faser-verbund	MMS	max.	ohne	AIR
40-2041	●	●	●	●	●	○			●	●	●	●	○	○	●	○	●	○	●	●

Schnittdaten siehe Seite / cutting data available on page – 234 ● sehr gut geeignet / very suitable ○ bedingt geeignet / limited suitable

Ø d1 (h10) mm	40-2041	l2	l3	Hals Ø d3	l1	Ø d4	Ø d2 (h6) mm
	TA	mm	mm	mm	mm	mm	mm
2,8		3	11	2	75	—	6
3,8		4	14	3	75	—	6
4,8		5	16,5	4	75	—	6

Ø d1 (h10) mm	40-2041	l2	l3	Hals Ø d3	l1	Ø d4	Ø d2 (h6) mm
	TA	mm	mm	mm	mm	mm	mm
5,8		6	20	4	100	3	6
7,8		8	25	5,4	100	3,5	6
9,8		9	—	—	100	5	6

Bestellbeispiel / Order example: HA-Schaft/shank 40-2041-5,8
HB-Schaft/shank 40-2041-5,8-HB



Produktivität am Maximum

- höchstmögliche Produktivität durch maximale Schneidenzahl
- PKD-Schneideinsatz garantiert höchste Präzision bei optimaler Oberflächengüte
- wesentlich höhere Standzeiten erreichbar als mit herkömmlichen Frässystemen
- Schneidenjustage – optimiert und vereinfacht durch seitliche Feineinstellung

Maximum Productivity

- *highest possible efficiency due to maximum number of teeth*
- *PCD-cutting insert guarantees highest precision and optimal surface quality*
- *considerably higher tool life is achieved compared to conventional cutter systems*
- *the cutting adjustment is optimised and simplified by edgewise (sidewise) fine adjustment*

Diamant-Messerkopf-Systeme
diamond milling cutter systems

HAM 40-7690

1D-Hochleistungs-PKD-Diamant-Fräskopf 1D-Highspeed-PCD-Diamond Milling Cutter

PKD	Z 5-24	Werk Norm
Typ W		HSK SK
HSC		

Konstruktions-Daten

- höchstmögliche Produktivität
- optimale Oberflächengüte und hohe Standzeiten
- sehr einfache Schneideneinstellung

Engineering data

- highest possible productivity
- optimal surface quality and high tool life
- very simple adjustment

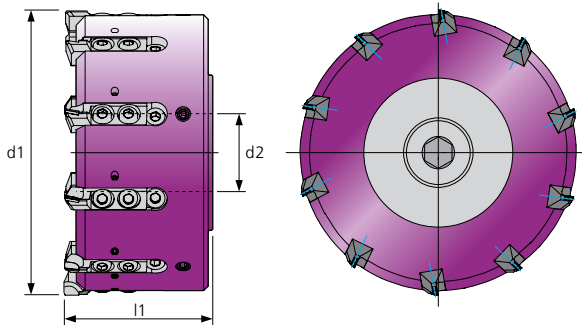

Lieferumfang:

- montiert und gewuchtet
- mit Eck- oder Planschneiden
HAM 3183-4 / 3182-4 (Seite 150)
- mit Anzugschraube (mit IK)
- ohne Fräskopfaufnahme

Delivery Scale:

- mounted and balanced
- with corner or face cutting edges
HAM 3183-4 / 3182-4 (page 150)
- with tightening screw (with IC)
- without cutter adaptor

Material	Alu Knet-leg.	Alu Guss-leg.	Stahl < 800 N/mm²	Stahl < 1200 N/mm²	Stahl < 1600 N/mm²	Stahl < 55 HRC	Stahl < 60 HRC	Stahl < 66 HRC	INOX < 800 N/mm²	INOX > 800 N/mm²	GG	GGG	hochw. Legierungen	Titan	NE-Metalle Cu-Leg.	Graphit & Faser-verbund	MMS	max.	ohne	AIR
40-7690	●	●													●	●	●	●		○

● sehr gut geeignet / very suitable ○ bedingt geeignet / limited suitable

Ø d1 mm	40-7690	l1 mm	Z	n max. min ⁻¹	Gewicht weight ca. kg	Aufnahme Ø d2 mm
	PKD					
80		65	5	18.000	0,8	27
100		65	7	16.000	1,3	32
125		65	10	14.000	2,2	40
160		65	12	8.000	3,2	40

Ø d1 mm	40-7690	l1 mm	Z	n max. min ⁻¹	Gewicht weight ca. kg	Aufnahme Ø d2 mm
	PKD					
200		65	16	7.000	4,7	60
250		65	20	6.000	7,2	60
315		65	24	4.000	11,4	60

Bestellbeispiel / Order example: 40-7690-200



HAM 40-7670

1D-Hochleistungs-PKD-Diamant-Fräskopf 1D-Highspeed-PCD-Diamond Milling Cutter

PKD	Z 10-48	Werk Norm
Typ W		HSK SK
HSC		

Konstruktions-Daten

- höchstmögliche Produktivität
- optimale Oberflächengüte und hohe Standzeiten
- sehr einfache Schneideneinstellung

Engineering data

- highest possible productivity
- optimal surface quality and high tool life
- very simple adjustment

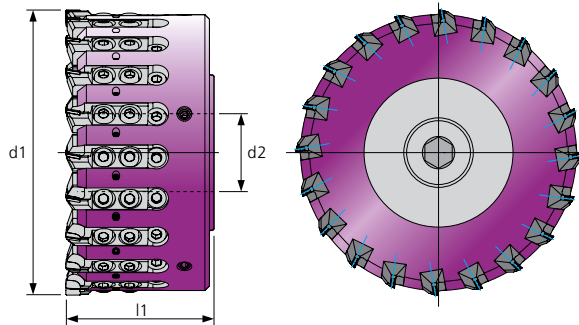

Lieferumfang:

- montiert und gewuchtet
- mit Eck- oder Planschneiden
HAM 3183-4 / 3182-4 (Seite 150)
- mit Anzugschraube (mit IK)
- ohne Fräskopfaufnahme

Delivery Scale:

- mounted and balanced
- with corner or face cutting edges
HAM 3183-4 / 3182-4 (page 150)
- with tightening screw (with IC)
- without cutter adaptor

Material	Alu Knet-leg.	Alu Guss-leg.	Stahl < 800 N/mm²	Stahl < 1200 N/mm²	Stahl < 1600 N/mm²	Stahl < 55 HRC	Stahl < 60 HRC	Stahl < 66 HRC	INOX < 800 N/mm²	INOX > 800 N/mm²	GG	GGG	hochw. Legierungen	Titan	NE-Metalle Cu-Leg.	Graphit & Faser-verbund	MMS	max.	ohne	AIR
40-7670	●	●													●	●	●	●		○

● sehr gut geeignet / very suitable ○ bedingt geeignet / limited suitable

Ø d1 mm	40-7670	l1 mm	Z	n max. min ⁻¹	Gewicht weight ca. kg	Aufnahme Ø d2 mm
	PKD					
80		65	10	18.000	0,9	27
100		65	14	16.000	1,4	32
125		65	20	14.000	2,4	40
160		65	24	8.000	3,4	40

Ø d1 mm	40-7670	l1 mm	Z	n max. min ⁻¹	Gewicht weight ca. kg	Aufnahme Ø d2 mm
	PKD					
200		65	32	7.000	4,7	60
250		65	40	6.000	7,4	60
315		65	48	4.000	11,4	60

Bestellbeispiel / Order example: 40-7670-200



HAM 40-7750

2D-Hochleistungs-PKD-Diamant-Fräskopf 2D-Highspeed-PCD-Diamond Milling Cutter

PKD	Z 4-24	Werk Norm
Typ W		HSK SK
HSC		

Konstruktions-Daten

- höchstmögliche Produktivität
- optimale Oberflächengüte und hohe Standzeiten
- sehr einfache Schneideneinstellung

Engineering data

- highest possible productivity
- optimal surface quality and high tool life
- very simple adjustment

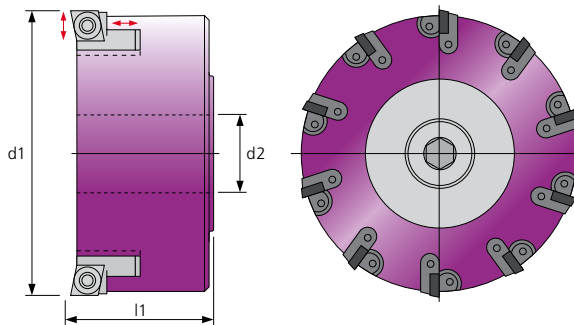

Lieferumfang:

- montiert und gewuchtet
- ohne PKD-Wendeschneidplatten
- mit Anzugschraube (mit IK)
- ohne Fräskopfaufnahme

Delivery Scale:

- mounted and balanced
- without PCD-indexable inserts
- with tightening screw (with IK)
- without cutter adaptor

Unsere Empfehlung für 2D-Fräskopf: PKD-Wendeschneidplatten HAM 3177 oder HAM 3178 (Seite 151).
Our recommendation for 2D-Milling Cutter: PCD-indexable inserts HAM 3177 or HAM 3178 (page 151).

Material	Alu Knet-leg.	Alu Guss-leg.	Stahl < 800 N/mm²	Stahl < 1200 N/mm²	Stahl < 1600 N/mm²	Stahl < 55 HRC	Stahl < 60 HRC	Stahl < 66 HRC	INOX < 800 N/mm²	INOX > 800 N/mm²	GG	GGG	hochw. Legierungen	Titan	NE-Metalle Cu-Leg.	Graphit & Faser-verbund	MMS	max.	ohne	AIR
40-7750	●	●													●	●	●	●		○

● sehr gut geeignet / very suitable ○ bedingt geeignet / limited suitable

Ø d1 mm	40-7750	l1 mm	Z	n max. min ⁻¹	Gewicht weight ca. kg	Aufnahme Ø d2 mm
	PKD					
80		65	4	20.000	1,0	27
100		65	6	18.000	1,8	32
125		65	7	16.000	2,9	40
160		65	10	8.000	3,6	40

Ø d1 mm	40-7750	l1 mm	Z	n max. min ⁻¹	Gewicht weight ca. kg	Aufnahme Ø d2 mm
	PKD					
200		65	12	7.000	5,4	60
250		65	16	6.000	7,9	60
315		65	24	4.000	12,7	60

Bestellbeispiel / Order example: 40-7750-200



HAM 40-7770

2D-Hochleistungs-PKD-Diamant-Fräskopf 2D-Highspeed-PCD-Diamond Milling Cutter

PKD Z 10-28 Werk Norm
 Typ W HSK SK
 HSC

- Konstruktions-Daten**
- höchstmögliche Produktivität
 - optimale Oberflächengüte und hohe Standzeiten
 - sehr einfache Schneideneinstellung

- Engineering data**
- highest possible productivity
 - optimal surface quality and high tool life
 - very simple adjustment

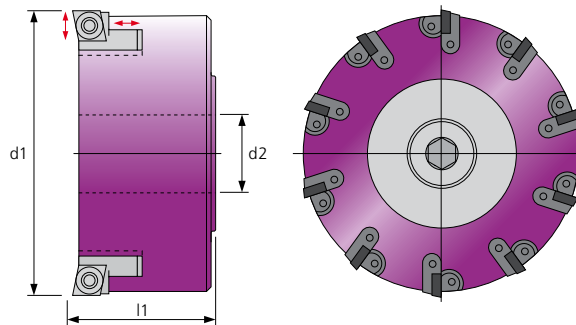

- Lieferumfang:**
- montiert und gewuchtet
 - ohne PKD-Wendeschneidplatten
 - mit Anzugschraube (mit IK)
 - ohne Fräskopfaufnahme

- Delivery Scale:**
- mounted and balanced
 - without PCD-indexable inserts
 - with tightening screw (with IC)
 - without cutter adaptor

Unsere Empfehlung für 2D-Fräskopf: PKD-Wendeschneidplatten HAM 3177 oder HAM 3178 (Seite 151).
 Our recommendation for 2D-Milling Cutter: PCD-indexable inserts HAM 3177 or HAM 3178 (page 151).

Material	Alu Knet-leg.	Alu Guss-leg.	Stahl < 800 N/mm²	Stahl < 1200 N/mm²	Stahl < 1600 N/mm²	Stahl < 55 HRC	Stahl < 60 HRC	Stahl < 66 HRC	INOX < 800 N/mm²	INOX > 800 N/mm²	GG	GGG	hochw. Legierungen	Titan	NE-Metalle Cu-Leg.	Graphit & Faser-verbund	MMS	max.	ohne	AIR
40-7770	●	●													●	●	●	●		○

● sehr gut geeignet / very suitable ○ bedingt geeignet / limited suitable

Ø d1 mm	40-7770	l1 mm	Z	n max. min ⁻¹	Gewicht weight ca. kg	Aufnahme Ø d2 mm
	PKD					
125		65	10	16.000	2,5	40
160		65	12	8.000	3,7	40
200		65	16	7.000	5,6	60

Ø d1 mm	40-7770	l1 mm	Z	n max. min ⁻¹	Gewicht weight ca. kg	Aufnahme Ø d2 mm
	PKD					
250		65	20	6.000	8,0	60
315		65	28	4.000	13,0	60

Bestellbeispiel / Order example: 40-7770-250

HAM 40-7640

PKD-HPC Aufsteckfräser PCD-HPC arbor milling cutter

PKD Z 5-7 Werk Norm
 Typ W HSK SK
 HSC

- Konstruktions-Daten**
- höchstmögliche Produktivität
 - optimale Oberflächengüte und hohe Standzeiten
 - Eckschneiden 90°

- Engineering data**
- highest possible productivity
 - optimal surface quality and high tool life
 - corner cutting edges 90°

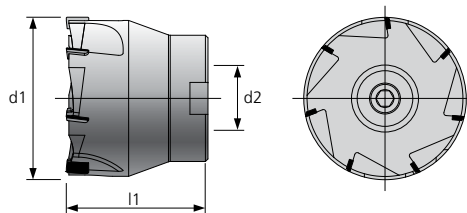

- Lieferumfang:**
- mit Anzugschraube (mit IK)
 - ohne Fräskopfaufnahme
- Delivery Scale:**
- with tightening screw (with IC)
 - without cutter adaptor

Material	Alu Knet-leg.	Alu Guss-leg.	Stahl < 800 N/mm²	Stahl < 1200 N/mm²	Stahl < 1600 N/mm²	Stahl < 55 HRC	Stahl < 60 HRC	Stahl < 66 HRC	INOX < 800 N/mm²	INOX > 800 N/mm²	GG	GGG	hochw. Legierungen	Titan	NE-Metalle Cu-Leg.	Graphit & Faser-verbund	MMS	max.	ohne	AIR
40-7640	●	●													●	●	●	●		○

● sehr gut geeignet / very suitable ○ bedingt geeignet / limited suitable

Ø d1 mm	40-7640	l1 mm	Z	n max. min ⁻¹	Gewicht weight ca. kg	Aufnahme Ø d2 mm
	PKD					
40		50	5	20.000	0,6	22
50		50	5	20.000	0,7	22

Ø d1 mm	40-7640	l1 mm	Z	n max. min ⁻¹	Gewicht weight ca. kg	Aufnahme Ø d2 mm
	PKD					
63		55	7	20.000	0,8	27

Bestellbeispiel / Order example: 40-7640-63

HAM 40-6250

HSK-Fräskopfaufnahme HSK-Cutter adaptor

Konstruktions-Daten

- höchste Genauigkeit für Rund- und Planlauf
- eingeschränkte Toleranz

Engineering data

- high concentricity
- narrowed tolerance

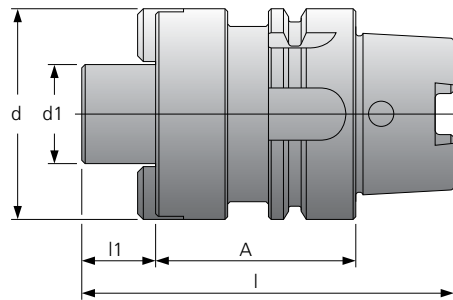

*Zusätzlich 4 Befestigungsgewinde nach DIN 2079. Sonderabmessungen auf Anfrage.

*Additional 4 fastening screw threads acc. DIN 2079. Special measurements on request.

Kühlmittelübergabeeinheit im Lieferumfang nicht enthalten.

Cooling tube not included in the package.

Ø d1 mm	40-6250	HSK DIN 69893-A	Ø d mm	l mm	l1 mm	Gewicht weight ca. kg	A mm
22		63	42	103	19	1,0	50
22		63	42	113	19	1,1	60
27		63	50	103	21	1,1	50
27		63	50	113	21	1,2	60

Ø d1 mm	40-6250	HSK DIN 69893-A	Ø d mm	l mm	l1 mm	Gewicht weight ca. kg	A mm
32		63	60	116	24	1,4	60
40		63	70	119	27	1,6	60
40*		63	90	119	28	2,0	60
60*		100	130	160	40	5,1	70

Bestellbeispiel / Order example: 40-6250-32-60-60

HAM 40-6200

SK-Fräskopfaufnahme SK-Cutter adaptor

Konstruktions-Daten

- höchste Genauigkeit für Rund- und Planlauf
- eingeschränkte Toleranz

Engineering data

- high concentricity
- narrowed tolerance

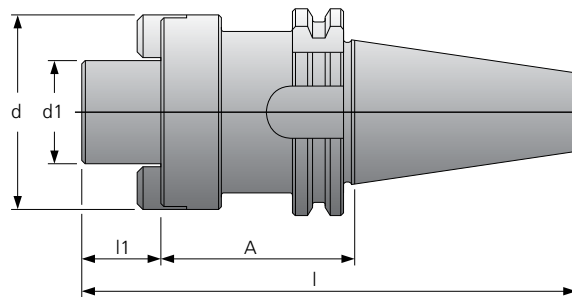

*Zusätzlich 4 Befestigungsgewinde nach DIN 2079. Sonderabmessungen auf Anfrage.

*Additional 4 fastening screw threads acc. DIN 2079. Special measurements on request.

Ø d1 mm	40-6200	SK DIN 69871-AD	Ø d mm	l mm	l1 mm	Gewicht weight ca. kg	A mm
22		40	42	129,4	19	1,1	40
22		40	42	149,4	19	1,3	60
27		40	50	129,4	21	1,3	40
27		40	50	149,4	21	1,5	60
32		40	60	142,4	24	1,6	50

Ø d1 mm	40-6200	SK DIN 69871-AD	Ø d mm	l mm	l1 mm	Gewicht weight ca. kg	A mm
32		40	60	152,4	24	1,7	60
40		40	70	145,4	27	1,9	50
40		40	70	155,4	27	2,0	60
40*		40	90	156,4	28	2,5	60
60*		50	130	211,0	40	6,1	70

Bestellbeispiel / Order example: 40-6200-32-60-60

Einstellung

adjustment

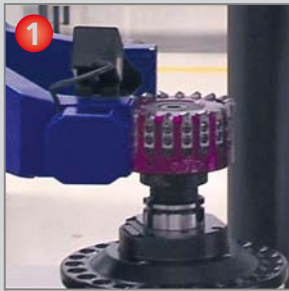

Diamantmesserkopf mit montierten Schneideinsätzen im optischen Einstellgerät aufnehmen.

Adjust diamond milling head with mounted cutting inserts in the optical adjustment device.



Befestigungsschrauben mit 1 Nm anlegen.

Tighten fastening screws to 1 Nm.



PKD-Schneideinsätze mit den Justierschrauben auf Planlauf $\pm 0,003$ mm einstellen.

Adjust PCD cutting inserts with adjusting screws to axial runout $\pm 0,003$ mm.



Befestigungsschrauben mit Drehmomentschlüssel anziehen (6 Nm).

Tighten fastening screws with torque wrench to 6 Nm.



Planlauf kontrollieren, ggf. Vorgang wiederholen.

Einstellzeit pro Schneide ca. 2-3 Minuten.

Check axial runout and repeat procedure if necessary.

Adjustment time per cutting edge approximately 2-3 minutes.

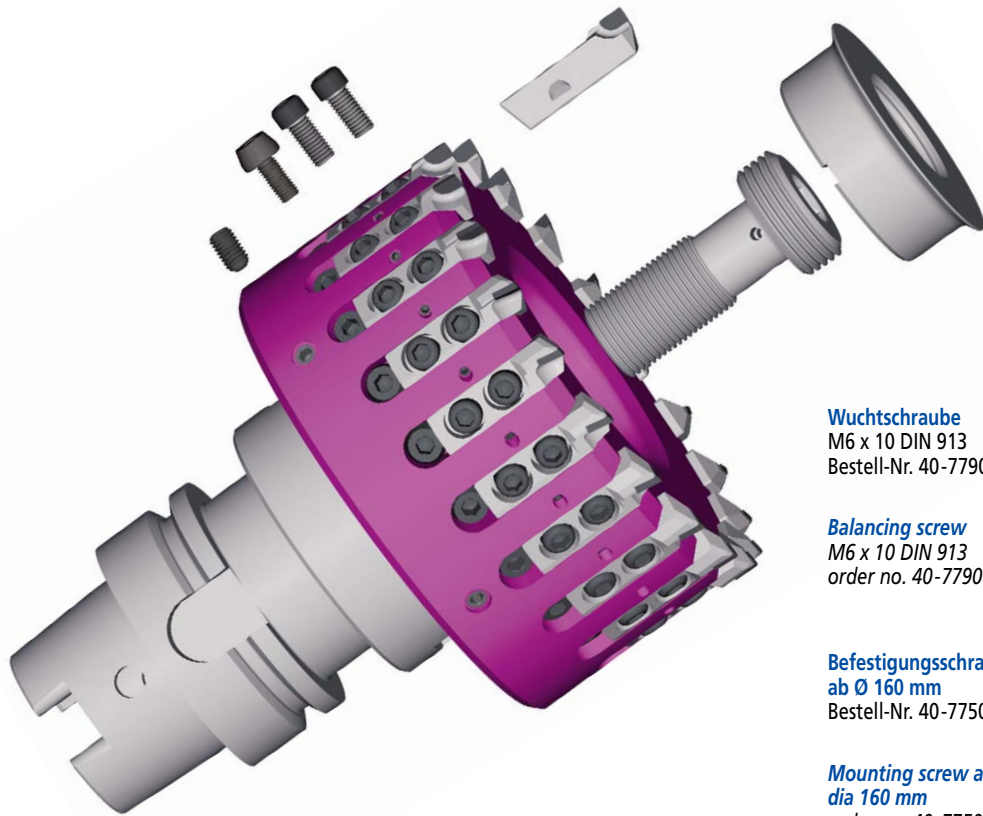

Fräseranzugschraube mit Kühlmittelzufuhr
 Ø 80 mm
 Bestell-Nr. 40-7750-080-03

Ø 100 mm
 Bestell-Nr. 40-7750-100-03

Ø 125 mm
 Bestell-Nr. 40-7750-125-03

Turbokühlmittelzufuhr
 Ø 160 mm
 Bestell-Nr. 40-7670-160-05

Wuchtschraube
 M6 x 10 DIN 913
 Bestell-Nr. 40-7790-900-55

Balancing screw
 M6 x 10 DIN 913
 order no. 40-7790-900-55

Cutter tightening screw with internal coolant supply
 dia 80 mm
 order no. 40-7750-080-03

dia 100 mm
 order no. 40-7750-100-03

Befestigungsschraube ab Ø 160 mm
 Bestell-Nr. 40-7750-912-16-00

dia 125 mm
 order no. 40-7750-125-03

Mounting screw as from dia 160 mm
 order no. 40-7750-912-16-00

Turbo coolant supply
 dia 160 mm
 order no. 40-7670-160-05

HAM 40-7000 1D-Diamant-Schneideinsatz 75°
 (HAM 3182) 1D-Diamond cutting insert 75°

für Typ: HAM 40-7670
 HAM 40-7690

- Konstruktions-Daten**
- PKD-bestückt
 - zum Planfräsen (75°)

for Type: HAM 40-7670
 HAM 40-7690

- Engineering data**
- PCD-tipped
 - for face milling (75°)

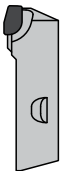

	40-7000		Schneidlänge cutting length mm	bestückt tipped
3182-4		6° diagonal	6	PKD/PCD

Bestellbeispiel / Order example: 40-7000-3182-4

HAM 40-7020 1D-Diamant-Schneideinsatz 90°
 (HAM 3183) 1D-Diamond cutting insert 90°

für Typ: HAM 40-7670
 HAM 40-7690

- Konstruktions-Daten**
- PKD-bestückt
 - zum Absatzfräsen (90°)

for Type: HAM 40-7670
 HAM 40-7690

- Engineering data**
- PCD-tipped
 - for corner milling (90°)



	40-7020		Schneidlänge cutting length mm	bestückt tipped
3183-4 3183-7		10° diagonal 6° diagonal	6 6	PKD/PCD PKD/PCD

Bestellbeispiel / Order example: 40-7020-3183-4

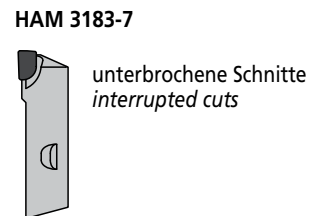

HAM 40-7040 PKD-Wendeschneidplatte 75° für 2D-Fräskopf
(HAM 3154) *PCD-Indexable insert 75° for 2D-Milling cutter*

für Typ: HAM 40-7710

for Type: HAM 40-7710

Konstruktions-Daten

- PKD- oder CBN-bestückt
- zum Planfräsen (75°)
- ISO-Norm (CPMX 09T3 EP R)

Engineering data

- PCD- or CBN-tipped
- for face milling (75°)
- ISO standard (CPMX 09T3 EP R)

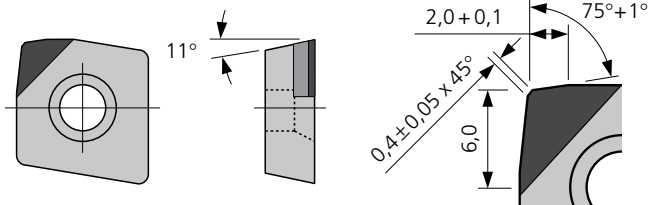

40-7040			Schneidlänge cutting length mm	bestückt tipped
3154-1	—		5	CBN
3154-2	—		4	PKD/PCD
3154-3	—		6	PKD/PCD
3154-5	6° axial Spanwinkel		6	PKD/PCD

Bestellbeispiel / Order example: 40-7040-3154-1

HAM 40-7060 PKD-Wendeschneidplatte 90° für 2D-Fräskopf
(HAM 3155) *PCD-Indexable insert 90° for 2D-Milling cutter*

für Typ: HAM 40-7710

for Type: HAM 40-7710

Konstruktions-Daten

- PKD- oder CBN-bestückt
- zum Absatzfräsen (90°)
- ISO-Norm (CPMX 09T3 PP R)

Engineering data

- PCD- or CBN-tipped
- for corner milling (90°)
- ISO standard (CPMX 09T3 PP R)

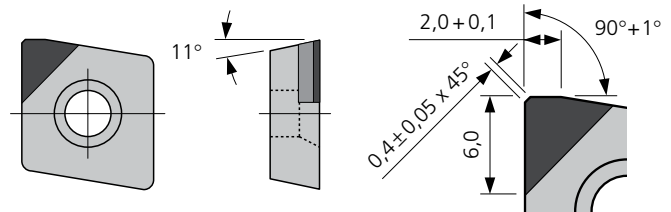

40-7060			Schneidlänge cutting length mm	bestückt tipped
3155-1	—		5	CBN
3155-2	—		4	PKD/PCD
3155-3	—		6	PKD/PCD
3155-5	6° axial Spanwinkel		6	PKD/PCD

Bestellbeispiel / Order example: 40-7060-3155-1

HAM 40-7080 PKD-Wendeschneidplatte 75° für 2D-Fräskopf
(HAM 3177) *PCD-Indexable insert 75° for 2D-Milling cutter*

für Typ: HAM 40-7750
HAM 40-7770

for Type: HAM 40-7750
HAM 40-7770

Konstruktions-Daten

- PKD- oder CBN-bestückt
- zum Planfräsen (75°)
- ISO-Norm (CPMX 12 04 EP R)

Engineering data

- PCD- or CBN-tipped
- for face milling (75°)
- ISO standard (CPMX 12 04 EP R)

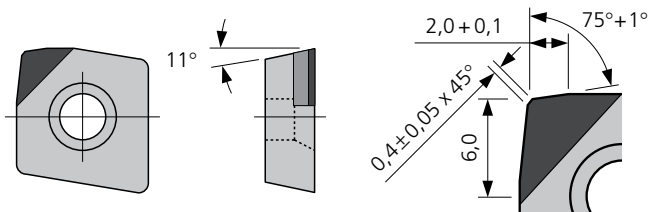

40-7080			Schneidlänge cutting length mm	bestückt tipped
3177-1	—		5	CBN
3177-2	—		4	PKD/PCD
3177-3	—		6	PKD/PCD
3177-5	6° axial Spanwinkel		6	PKD/PCD
3177-4	—		6	CVD

Bestellbeispiel / Order example: 40-7080-3177-1

HAM 40-7100 PKD-Wendeschneidplatte 90° für 2D-Fräskopf
(HAM 3178) *PCD-Indexable insert 90° for 2D-Milling cutter*

für Typ: HAM 40-7750
HAM 40-7770

for Type: HAM 40-7750
HAM 40-7770

Konstruktions-Daten

- PKD- oder CBN-bestückt
- zum Absatzfräsen (90°)
- ISO-Norm (CPMX 12 04 PP R)

Engineering data

- PCD- or CBN-tipped
- for corner milling (90°)
- ISO standard (CPMX 12 04 PP R)

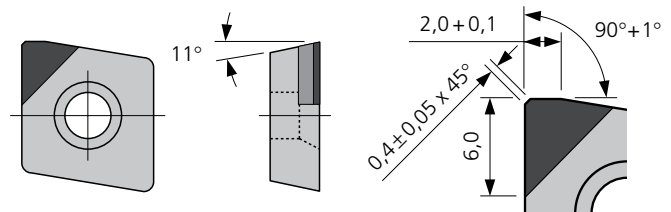

40-7100			Schneidlänge cutting length mm	bestückt tipped
3178-1	—		5	CBN
3178-2	—		4	PKD/PCD
3178-3	—		6	PKD/PCD
3178-5	6° axial Spanwinkel		6	PKD/PCD
3178-4	—		6	CVD

Bestellbeispiel / Order example: 40-7100-3178-1

Schnittdaten Bohren

cutting data drilling

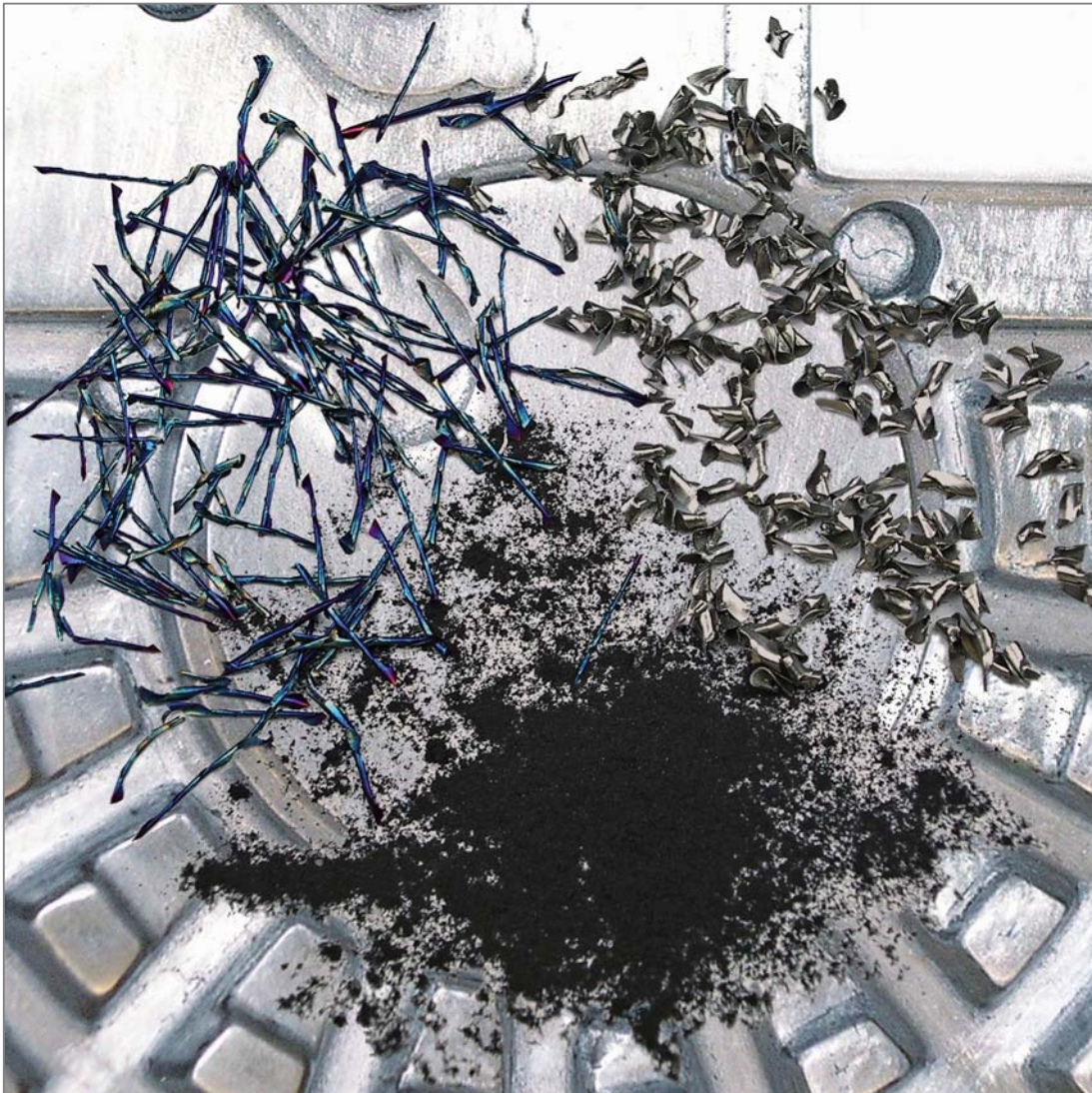

Diese Schnittdaten sind Richtwerte, die am oberen Bearbeitungslimit orientiert sind. Sie müssen auf die jeweiligen Einsatzbedingungen nach eigenen Erfahrungen angepasst werden.

These cutting data are based on our experience and determined for the upper machining limit. They have to be adjusted to particular working conditions.

Formeln für die Zerspanung / Formulas for the machining		
Drehzahl <i>revolution</i>	$n = \frac{v_c \times 1000}{\pi \times d_1}$	U/min <i>rev/min</i>
Schnittgeschwindigkeit <i>cutting speed</i>	$v_c = \frac{d_1 \times \pi \times n}{1000}$	m/min <i>m/min</i>
Vorschubgeschwindigkeit <i>feed rate</i>	$v_f = f \times n$	mm/min <i>mm/min</i>
Vorschub pro Umdrehung <i>feed per revolution</i>	$f = \frac{v_f}{n}$	mm/U <i>mm/rev</i>
Zeitspanvolumen <i>machining volume</i>	$Q = \frac{d^2 \times \pi \times v_f}{4 \times 1000}$	cm ³ /min <i>cm³/min</i>

HAM 30-1000

Vollhartmetall-Spiralbohrer
solid carbide spiral drill

VHM Z 2 30° rechts Werk Norm
Typ N 120° HA

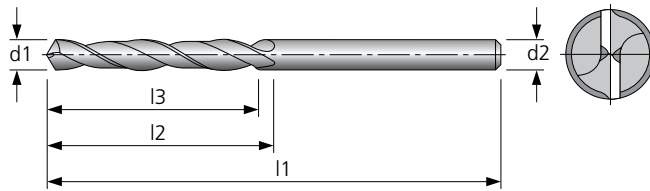

Material	Alu Knet-leg.	Alu Guss-leg.	Stahl < 800 N/mm²	Stahl < 1200 N/mm²	Stahl < 1600 N/mm²	Stahl < 55 HRC	Stahl < 60 HRC	Stahl < 66 HRC	INOX < 800 N/mm²	INOX > 800 N/mm²	GG	GGG	hochw. Legierungen	Titan	NE-Metalle Cu-Leg.	Graphit & Faser-verbund	MMS	max.	ohne	AIR
30-1000	○	○	○	○	○				○	○	○	○			●		○	●	○	○

● sehr gut geeignet / very suitable ○ bedingt geeignet / limited suitable

HAM 30-1000

Werkstoffgruppe material group	Ø mm	0,5 – 0,9	0,95 – 1,5	1,6 – 3
Alu Knetlegierungen	v _c [m/min]	180	180	180
	f [mm/U]	0,020	0,030	0,060
	v _f [mm/min]	400	600	1200
	n [1/min]	20000	20000	20000
Alu Gusslegierungen	v _c [m/min]	140	140	140
	f [mm/U]	0,020	0,030	0,060
	v _f [mm/min]	400	600	1070
	n [1/min]	20000	20000	17800
Stahl < 800 N/mm²	v _c [m/min]	70	70	70
	f [mm/U]	0,020	0,030	0,060
	v _f [mm/min]	400	510	530
	n [1/min]	20000	17100	8900
Stahl < 1200 N/mm²	v _c [m/min]	55	55	55
	f [mm/U]	0,020	0,030	0,050
	v _f [mm/min]	400	410	350
	n [1/min]	20000	13500	7000
Stahl < 1600 N/mm²	v _c [m/min]	40	40	40
	f [mm/U]	0,015	0,020	0,040
	v _f [mm/min]	260	200	200
	n [1/min]	17000	9800	5100
INOX < 800 N/mm²	v _c [m/min]	30	30	30
	f [mm/U]	0,010	0,015	0,025
	v _f [mm/min]	130	110	100
	n [1/min]	12700	7300	3800
INOX > 800 N/mm²	v _c [m/min]	25	25	25
	f [mm/U]	0,008	0,015	0,020
	v _f [mm/min]	80	90	60
	n [1/min]	10600	6100	3200
GG	v _c [m/min]	70	70	70
	f [mm/U]	0,020	0,030	0,060
	v _f [mm/min]	400	510	530
	n [1/min]	20000	17100	8900
GGG	v _c [m/min]	55	55	55
	f [mm/U]	0,020	0,030	0,050
	v _f [mm/min]	400	410	350
	n [1/min]	20000	13500	7000
NE-Metalle Cu-Legierungen	v _c [m/min]	120	120	120
	f [mm/U]	0,020	0,030	0,060
	v _f [mm/min]	400	600	920
	n [1/min]	20000	20000	15300

HAM 30-1080

Vollhartmetall-Spiralbohrer
solid carbide spiral drill

VHM Z2 30° rechts DIN 6539
Typ N 120° HA

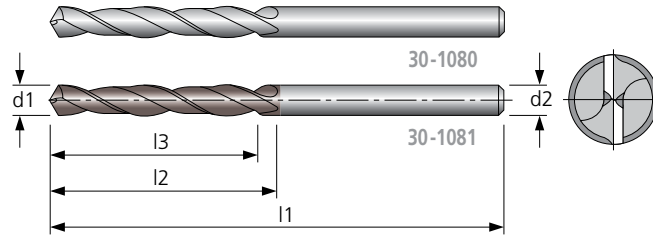

Material	Alu Knetleg.	Alu Gussleg.	Stahl < 800 N/mm²	Stahl < 1200 N/mm²	Stahl < 1600 N/mm²	Stahl < 55 HRC	Stahl < 60 HRC	Stahl < 66 HRC	INOX < 800 N/mm²	INOX > 800 N/mm²	GG	GGG	hochw. Legierungen	Titan	NE-Metalle Cu-Leg.	Graphit & Faserverbund	MMS	max.	ohne	AIR
30-1080	○	○	○	○	○				○	○	○	●			●		○	●	○	○
30-1081	○	○	●	●	○				○	○	●				○		○	●	○	○

● sehr gut geeignet / very suitable ○ bedingt geeignet / limited suitable

HAM 30-1080* / 30-1081		* unbeschichtete Werkzeuge HAM 30-1080: v _c x 0,8 (ca.) * uncoated tools HAM 30-1080: v _c x 0,8 (ca.)																		
Werkstoffgruppe material group	Ø mm	0,5 – 0,9	1 – 1,5	1,6 – 3	3,1 – 3,3	3,4 – 3,7	3,8 – 4,2	4,3 – 4,7	4,8 – 5,3	5,4 – 6	6,1 – 6,7									
Alu Knetlegierungen	v _c [m/min]	230	230	230	230	230	230	230	230	230	230									
	f [mm/U]	0,020	0,030	0,060	0,080	0,100	0,120	0,130	0,140	0,160	0,180									
	v _f [mm/min]	400	600	1200	1600	2000	2200	2120	2040	2020	2030									
	n [1/min]	20000	20000	20000	20000	20000	18300	16300	14600	12600	11300									
Alu Gusslegierungen	v _c [m/min]	180	180	180	180	180	180	180	180	180	180									
	f [mm/U]	0,020	0,030	0,060	0,080	0,100	0,120	0,130	0,140	0,160	0,180									
	v _f [mm/min]	400	600	1200	1460	1570	1720	1650	1610	1580	1580									
	n [1/min]	20000	20000	20000	18200	15700	14300	12700	11500	9900	8800									
Stahl < 800 N/mm²	v _c [m/min]	90	90	90	90	90	90	90	90	90	90									
	f [mm/U]	0,020	0,030	0,060	0,080	0,100	0,120	0,130	0,140	0,150	0,160									
	v _f [mm/min]	400	600	690	730	780	860	830	800	740	700									
	n [1/min]	20000	20000	11500	9100	7800	7200	6400	5700	4900	4400									
Stahl < 1200 N/mm²	v _c [m/min]	65	65	65	65	65	65	65	65	65	65									
	f [mm/U]	0,020	0,030	0,050	0,070	0,080	0,090	0,100	0,120	0,120	0,140									
	v _f [mm/min]	400	480	420	460	460	470	460	490	430	450									
	n [1/min]	20000	15900	8300	6600	5700	5200	4600	4100	3600	3200									
Stahl < 1600 N/mm²	v _c [m/min]	50	50	50	50	50	50	50	50	50	50									
	f [mm/U]	0,015	0,020	0,040	0,050	0,060	0,070	0,080	0,090	0,100	0,120									
	v _f [mm/min]	300	240	260	260	260	280	280	290	270	290									
	n [1/min]	20000	12200	6400	5100	4400	4000	3500	3200	2700	2400									
INOX < 800 N/mm²	v _c [m/min]	40	40	40	40	40	40	40	40	40	40									
	f [mm/U]	0,010	0,015	0,025	0,035	0,040	0,045	0,045	0,050	0,050	0,055									
	v _f [mm/min]	170	150	130	140	140	140	130	130	110	110									
	n [1/min]	17000	9800	5100	4000	3500	3200	2800	2500	2200	2000									
INOX > 800 N/mm²	v _c [m/min]	30	30	30	30	30	30	30	30	30	30									
	f [mm/U]	0,008	0,015	0,020	0,030	0,030	0,035	0,035	0,040	0,040	0,045									
	v _f [mm/min]	100	110	80	90	80	80	70	80	60	70									
	n [1/min]	12700	7300	3800	3000	2600	2400	2100	1900	1600	1500									
GG	v _c [m/min]	85	85	85	85	85	85	85	85	85	85									
	f [mm/U]	0,020	0,030	0,060	0,080	0,100	0,120	0,130	0,140	0,150	0,160									
	v _f [mm/min]	400	600	650	690	740	820	780	760	710	670									
	n [1/min]	20000	20000	10800	8600	7400	6800	6000	5400	4700	4200									
GGG	v _c [m/min]	65	65	65	65	65	65	65	65	65	65									
	f [mm/U]	0,020	0,030	0,050	0,070	0,080	0,090	0,100	0,120	0,120	0,140									
	v _f [mm/min]	400	480	420	460	460	470	460	490	430	450									
	n [1/min]	20000	15900	8300	6600	5700	5200	4600	4100	3600	3200									
NE-Metalle Cu-Legierungen	v _c [m/min]	150	150	150	150	150	150	150	150	150	150									
	f [mm/U]	0,020	0,030	0,060	0,080	0,100	0,120	0,130	0,140	0,160	0,180									
	v _f [mm/min]	400	600	1150	1220	1310	1430	1380	1330	1310	1310									
	n [1/min]	20000	20000	19100	15200	13100	11900	10600	9500	8200	7300									

HAM 30-1080* / 30-1081		* unbeschichtete Werkzeuge HAM 30-1080: $v_c \times 0,8$ (ca.) * uncoated tools HAM 30-1080: $v_c \times 0,8$ (ca.)								
Werkstoffgruppe material group	Ø mm	6,8 – 7,5	7,6 – 8,5	8,6 – 9,5	10 – 10,5	11 – 11,5	12 – 13	14	15	16
Alu Knetlegierungen	v_c [m/min]	230	230	230	230	230	230	230	230	230
	f [mm/U]	0,200	0,220	0,240	0,260	0,280	0,300	0,320	0,320	0,350
	v_f [mm/min]	2040	2020	1940	1870	1820	1770	1660	1570	1610
	n [1/min]	10200	9200	8100	7200	6500	5900	5200	4900	4600
Alu Gusslegierungen	v_c [m/min]	180	180	180	180	180	180	180	180	180
	f [mm/U]	0,200	0,220	0,240	0,260	0,280	0,300	0,320	0,320	0,350
	v_f [mm/min]	1600	1580	1540	1460	1430	1380	1310	1220	1260
	n [1/min]	8000	7200	6400	5600	5100	4600	4100	3800	3600
Stahl < 800 N/mm ²	v_c [m/min]	90	90	90	90	90	90	90	90	90
	f [mm/U]	0,180	0,200	0,220	0,240	0,250	0,260	0,260	0,280	0,300
	v_f [mm/min]	720	720	700	670	650	600	520	530	540
	n [1/min]	4000	3600	3200	2800	2600	2300	2000	1900	1800
Stahl < 1200 N/mm ²	v_c [m/min]	65	65	65	65	65	65	65	65	65
	f [mm/U]	0,140	0,160	0,160	0,180	0,180	0,200	0,220	0,240	0,250
	v_f [mm/min]	410	420	370	360	320	340	330	340	330
	n [1/min]	2900	2600	2300	2000	1800	1700	1500	1400	1300
Stahl < 1600 N/mm ²	v_c [m/min]	50	50	50	50	50	50	50	50	50
	f [mm/U]	0,120	0,140	0,150	0,150	0,160	0,170	0,170	0,180	0,200
	v_f [mm/min]	260	280	270	240	220	220	190	200	200
	n [1/min]	2200	2000	1800	1600	1400	1300	1100	1100	1000
INOX < 800 N/mm ²	v_c [m/min]	40	40	40	40	40	40	40	40	40
	f [mm/U]	0,060	0,070	0,080	0,090	0,100	0,110	0,130	0,150	0,180
	v_f [mm/min]	110	110	110	110	110	110	120	120	140
	n [1/min]	1800	1600	1400	1200	1100	1000	900	800	800
INOX > 800 N/mm ²	v_c [m/min]	30	30	30	30	30	30	30	30	30
	f [mm/U]	0,050	0,055	0,065	0,070	0,080	0,090	0,105	0,130	0,140
	v_f [mm/min]	70	70	70	60	70	70	70	80	80
	n [1/min]	1300	1200	1100	900	900	800	700	600	600
GG	v_c [m/min]	85	85	85	85	85	85	85	85	85
	f [mm/U]	0,180	0,200	0,220	0,240	0,250	0,260	0,260	0,280	0,300
	v_f [mm/min]	680	680	660	650	600	570	490	500	510
	n [1/min]	3800	3400	3000	2700	2400	2200	1900	1800	1700
GGG	v_c [m/min]	65	65	65	65	65	65	65	65	65
	f [mm/U]	0,140	0,160	0,160	0,180	0,180	0,200	0,220	0,240	0,250
	v_f [mm/min]	410	420	370	360	320	340	330	340	330
	n [1/min]	2900	2600	2300	2000	1800	1700	1500	1400	1300
NE-Metalle Cu-Legierungen	v_c [m/min]	150	150	150	150	150	150	150	150	150
	f [mm/U]	0,200	0,220	0,240	0,260	0,280	0,300	0,320	0,320	0,350
	v_f [mm/min]	1320	1320	1270	1220	1200	1140	1090	1020	1050
	n [1/min]	6600	6000	5300	4700	4300	3800	3400	3200	3000

HAM 30-1120

Vollhartmetall-Spiralbohrer
solid carbide spiral drill

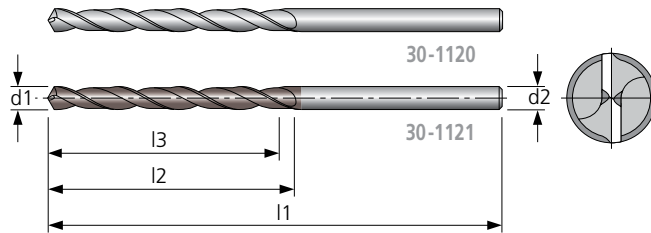
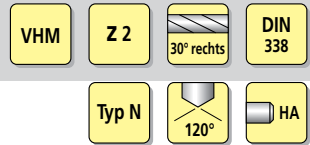

Material	Alu Knetleg.	Alu Gussleg.	Stahl < 800 N/mm²	Stahl < 1200 N/mm²	Stahl < 1600 N/mm²	Stahl < 55 HRC	Stahl < 60 HRC	Stahl < 66 HRC	INOX < 800 N/mm²	INOX > 800 N/mm²	GG	GGG	hochw. Legierungen	Titan	NE-Metalle Cu-Leg.	Graphit & Faserverbund	MMS	max.	ohne	AIR
30-1120	○	○	○	○	○				○	○	○	○			●		○	●	○	○
30-1121	○	○	●	●	○				○	○	●	●			○		○	●	○	○

● sehr gut geeignet / very suitable ○ bedingt geeignet / limited suitable

HAM 30-1120* / 30-1121		* unbeschichtete Werkzeuge HAM 30-1120: v _c x 0,8 (ca.) * uncoated tools HAM 30-1120: v _c x 0,8 (ca.)									
Werkstoffgruppe material group	Ø mm	1 – 1,5	1,6 – 3	3,1 – 3,3	3,4 – 3,7	3,8 – 4,2	4,3 – 4,7	4,8 – 5,3	5,4 – 6	6,1 – 6,7	
Alu Knetlegierungen	v _c [m/min]	230	230	230	230	230	230	230	230	230	
	f [mm/U]	0,025	0,050	0,070	0,085	0,100	0,110	0,120	0,135	0,150	
	v _f [mm/min]	500	1000	1400	1700	1830	1790	1750	1730	1740	
	n [1/min]	20000	20000	20000	20000	18300	16300	14600	12800	11600	
Alu Gusslegierungen	v _c [m/min]	180	180	180	180	180	180	180	180	180	
	f [mm/U]	0,025	0,050	0,070	0,085	0,100	0,110	0,120	0,135	0,150	
	v _f [mm/min]	500	1000	1250	1390	1430	1400	1380	1360	1370	
	n [1/min]	20000	20000	17900	16400	14300	12700	11500	10100	9100	
Stahl < 800 N/mm²	v _c [m/min]	90	90	90	90	90	90	90	90	90	
	f [mm/U]	0,025	0,050	0,070	0,085	0,100	0,110	0,120	0,125	0,135	
	v _f [mm/min]	500	630	630	700	720	700	680	630	610	
	n [1/min]	20000	12500	9000	8200	7200	6400	5700	5000	4500	
Stahl < 1200 N/mm²	v _c [m/min]	65	65	65	65	65	65	65	65	65	
	f [mm/U]	0,025	0,040	0,060	0,070	0,075	0,085	0,090	0,100	0,110	
	v _f [mm/min]	400	360	390	410	390	390	370	360	360	
	n [1/min]	15900	9000	6500	5900	5200	4600	4100	3600	3300	
Stahl < 1600 N/mm²	v _c [m/min]	50	50	50	50	50	50	50	50	50	
	f [mm/U]	0,015	0,035	0,040	0,050	0,060	0,070	0,075	0,085	0,090	
	v _f [mm/min]	180	240	200	230	240	250	240	240	230	
	n [1/min]	12200	6900	5000	4500	4000	3500	3200	2800	2500	
INOX < 800 N/mm²	v _c [m/min]	40	40	40	40	40	40	40	40	40	
	f [mm/U]	0,015	0,020	0,030	0,035	0,040	0,040	0,045	0,045	0,050	
	v _f [mm/min]	150	110	120	130	130	110	110	100	100	
	n [1/min]	9800	5500	4000	3600	3200	2800	2500	2200	2000	
INOX > 800 N/mm²	v _c [m/min]	30	30	30	30	30	30	30	30	30	
	f [mm/U]	0,010	0,015	0,025	0,025	0,030	0,030	0,035	0,035	0,040	
	v _f [mm/min]	70	60	80	70	70	60	70	60	60	
	n [1/min]	7300	4200	3000	2700	2400	2100	1900	1700	1500	
GG	v _c [m/min]	85	85	85	85	85	85	85	85	85	
	f [mm/U]	0,025	0,050	0,070	0,085	0,100	0,110	0,120	0,125	0,135	
	v _f [mm/min]	500	590	600	650	680	660	650	590	580	
	n [1/min]	20000	11800	8500	7700	6800	6000	5400	4700	4300	
GGG	v _c [m/min]	70	70	70	70	70	70	70	70	70	
	f [mm/U]	0,025	0,040	0,060	0,070	0,075	0,085	0,090	0,100	0,110	
	v _f [mm/min]	430	390	420	450	420	430	410	390	390	
	n [1/min]	17100	9700	7000	6400	5600	5000	4500	3900	3500	
NE-Metalle Cu-Legierungen	v _c [m/min]	180	180	180	180	180	180	180	180	180	
	f [mm/U]	0,025	0,050	0,070	0,085	0,100	0,110	0,120	0,135	0,150	
	v _f [mm/min]	500	1000	1250	1390	1430	1400	1380	1360	1370	
	n [1/min]	20000	20000	17900	16400	14300	12700	11500	10100	9100	

HAM 30-1120* / 30-1121		* unbeschichtete Werkzeuge HAM 30-1120: $v_c \times 0,8$ (ca.) * uncoated tools HAM 30-1120: $v_c \times 0,8$ (ca.)							
Werkstoffgruppe material group	Ø mm	6,8 – 7,5	7,6 – 8,5	8,6 – 9,5	10 – 10,5	11 – 11,5	12	14	16
Alu Knetlegierungen	v_c [m/min]	230	230	230	230	230	230	230	230
	f [mm/U]	0,170	0,185	0,200	0,220	0,240	0,255	0,270	0,300
	v_f [mm/min]	1790	1700	1540	1540	1540	1500	1400	1380
	n [1/min]	10500	9200	7700	7000	6400	5900	5200	4600
Alu Gusslegierungen	v_c [m/min]	180	180	180	180	180	180	180	180
	f [mm/U]	0,170	0,185	0,200	0,220	0,240	0,255	0,270	0,300
	v_f [mm/min]	1390	1330	1200	1210	1200	1170	1110	1080
	n [1/min]	8200	7200	6000	5500	5000	4600	4100	3600
Stahl < 800 N/mm ²	v_c [m/min]	90	90	90	90	90	90	90	90
	f [mm/U]	0,150	0,170	0,185	0,200	0,210	0,220	0,220	0,250
	v_f [mm/min]	620	610	560	540	530	510	440	450
	n [1/min]	4100	3600	3000	2700	2500	2300	2000	1800
Stahl < 1200 N/mm ²	v_c [m/min]	65	65	65	65	65	65	65	65
	f [mm/U]	0,120	0,130	0,135	0,150	0,150	0,170	0,190	0,210
	v_f [mm/min]	360	340	300	300	270	290	290	270
	n [1/min]	3000	2600	2200	2000	1800	1700	1500	1300
Stahl < 1600 N/mm ²	v_c [m/min]	50	50	50	50	50	50	50	50
	f [mm/U]	0,100	0,120	0,130	0,130	0,140	0,140	0,150	0,170
	v_f [mm/min]	230	240	220	200	200	180	170	170
	n [1/min]	2300	2000	1700	1500	1400	1300	1100	1000
INOX < 800 N/mm ²	v_c [m/min]	40	40	40	40	40	40	40	40
	f [mm/U]	0,055	0,060	0,070	0,075	0,085	0,095	0,110	0,150
	v_f [mm/min]	100	100	90	90	90	100	100	120
	n [1/min]	1800	1600	1300	1200	1100	1000	900	800
INOX > 800 N/mm ²	v_c [m/min]	30	30	30	30	30	30	30	30
	f [mm/U]	0,045	0,050	0,055	0,060	0,070	0,080	0,090	0,120
	v_f [mm/min]	60	60	60	50	60	60	60	70
	n [1/min]	1400	1200	1000	900	800	800	700	600
GG	v_c [m/min]	85	85	85	85	85	85	85	85
	f [mm/U]	0,150	0,170	0,185	0,200	0,210	0,220	0,220	0,250
	v_f [mm/min]	590	580	520	520	500	480	420	430
	n [1/min]	3900	3400	2800	2600	2400	2200	1900	1700
GGG	v_c [m/min]	70	70	70	70	70	70	70	70
	f [mm/U]	0,120	0,130	0,135	0,150	0,150	0,170	0,190	0,210
	v_f [mm/min]	380	360	310	320	290	310	300	290
	n [1/min]	3200	2800	2300	2100	1900	1800	1600	1400
NE-Metalle Cu-Legierungen	v_c [m/min]	180	180	180	180	180	180	180	180
	f [mm/U]	0,170	0,185	0,200	0,220	0,240	0,255	0,270	0,300
	v_f [mm/min]	1390	1330	1200	1210	1200	1170	1110	1080
	n [1/min]	8200	7200	6000	5500	5000	4600	4100	3600

HAM 30-1160

Vollhartmetall-Spiralbohrer
solid carbide spiral drill

VHM Z2 30° rechts Werk Norm

Typ W 130° HA

SHRINK FIT

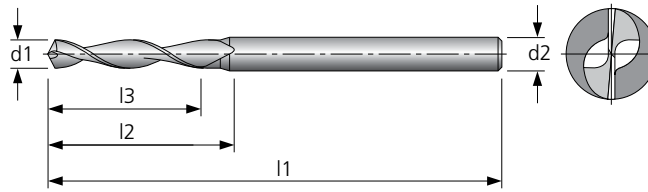

Material	Alu Knetleg.	Alu Gussleg.	Stahl < 800 N/mm²	Stahl < 1200 N/mm²	Stahl < 1600 N/mm²	Stahl < 55 HRC	Stahl < 60 HRC	Stahl < 66 HRC	INOX < 800 N/mm²	INOX > 800 N/mm²	GG	GGG	hochw. Legierungen	Titan	NE-Metalle Cu-Leg.	Graphit & Faserverbund	MMS	max.	ohne	AIR
30-1160	●	●	○	○					○	○	○			○	●	○	○	○	○	○

● sehr gut geeignet / very suitable ○ bedingt geeignet / limited suitable

HAM 30-1160

Werkstoffgruppe material group	Ø mm	0,5 – 0,6	0,65 – 0,7	0,75 – 0,85	0,9 – 1,15	1,2 – 1,9	2 – 3
Alu Knetlegierungen	v _c [m/min]	200	200	200	200	200	200
	f [mm/U]	0,020	0,025	0,030	0,040	0,060	0,100
	v _f [mm/min]	1000	1250	1500	2000	2390	2450
	n [1/min]	min. 50000	min. 50000	min. 50000	min. 50000	39800	24500
Alu Gusslegierungen	v _c [m/min]	160	160	160	160	160	160
	f [mm/U]	0,020	0,025	0,030	0,040	0,060	0,100
	v _f [mm/min]	1000	1250	1500	1850	1910	1960
	n [1/min]	min. 50000	min. 50000	min. 50000	46300	31800	19600
Stahl < 800 N/mm²	v _c [m/min]	60	60	60	60	60	60
	f [mm/U]	0,010	0,015	0,020	0,025	0,035	0,050
	v _f [mm/min]	350	410	480	440	420	370
	n [1/min]	34700	27300	23900	17400	11900	7300
Stahl < 1200 N/mm²	v _c [m/min]	50	50	50	50	50	50
	f [mm/U]	0,010	0,010	0,015	0,020	0,030	0,040
	v _f [mm/min]	290	230	300	290	300	240
	n [1/min]	28900	22700	19900	14500	9900	6100
INOX < 800 N/mm²	v _c [m/min]	30	30	30	30	30	30
	f [mm/U]	0,005	0,006	0,008	0,010	0,015	0,025
	v _f [mm/min]	90	80	100	90	90	90
	n [1/min]	17400	13600	11900	8700	6000	3700
INOX > 800 N/mm²	v _c [m/min]	25	25	25	25	25	25
	f [mm/U]	0,005	0,006	0,008	0,010	0,015	0,025
	v _f [mm/min]	70	70	80	70	80	80
	n [1/min]	14500	11400	9900	7200	5000	3100
GG	v _c [m/min]	65	65	65	65	65	65
	f [mm/U]	0,010	0,015	0,020	0,025	0,035	0,050
	v _f [mm/min]	380	440	520	470	450	400
	n [1/min]	37600	29600	25900	18800	12900	8000
Titan	v _c [m/min]	30	30	30	30	30	30
	f [mm/U]	0,005	0,006	0,008	0,010	0,015	0,025
	v _f [mm/min]	90	80	100	90	90	90
	n [1/min]	17400	13600	11900	8700	6000	3700
NE-Metalle Cu-Legierungen	v _c [m/min]	130	130	130	130	130	130
	f [mm/U]	0,015	0,017	0,025	0,030	0,040	0,070
	v _f [mm/min]	750	850	1250	1130	1040	1110
	n [1/min]	min. 50000	min. 50000	min. 50000	37600	25900	15900
Graphit & Faserverbund	v _c [m/min]	50	50	50	50	50	50
	f [mm/U]	0,010	0,012	0,016	0,020	0,030	0,045
	v _f [mm/min]	290	270	320	290	300	270
	n [1/min]	28900	22700	19900	14500	9900	6100

HAM 30-1200

Vollhartmetall-Spiralbohrer
solid carbide spiral drill

VHM Z 2 30° rechts DIN 338
Typ W 130° HA

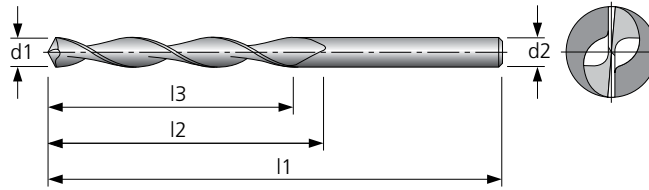

Material	Alu Knetleg.	Alu Gussleg.	Stahl < 800 N/mm²	Stahl < 1200 N/mm²	Stahl < 1600 N/mm²	Stahl < 55 HRC	Stahl < 60 HRC	Stahl < 66 HRC	INOX < 800 N/mm²	INOX > 800 N/mm²	GG	GGG	hochw. Legierungen	Titan	NE-Metalle Cu-Leg.	Graphit & Faserverbund	MMS	max.	ohne	AIR
30-1200	●	●	○	○					○	○	○			○	●	○	○	○	○	○

● sehr gut geeignet / very suitable ○ bedingt geeignet / limited suitable

HAM 30-1200

Werkstoffgruppe material group	Ø mm	1 – 1,1	1,2 – 1,9	2 – 3	3,1 – 3,7	3,8 – 4,2	4,3 – 4,7	4,8 – 5,3	5,4 – 6
Alu Knetlegierungen	v _c [m/min]	200	200	200	200	200	200	200	200
	f [mm/U]	0,040	0,060	0,100	0,120	0,140	0,150	0,160	0,180
	v _f [mm/min]	2000	2390	2550	2180	2230	2120	2000	1980
	n [1/min]	min. 50000	39800	25500	18200	15900	14100	12500	11000
Alu Gusslegierungen	v _c [m/min]	160	160	160	160	160	160	160	160
	f [mm/U]	0,040	0,060	0,100	0,120	0,140	0,150	0,160	0,180
	v _f [mm/min]	1850	1910	2040	1750	1780	1700	1600	1580
	n [1/min]	46300	31800	20400	14600	12700	11300	10000	8800
Stahl < 800 N/mm²	v _c [m/min]	60	60	60	60	60	60	60	60
	f [mm/U]	0,025	0,030	0,050	0,070	0,080	0,090	0,100	0,120
	v _f [mm/min]	440	360	380	390	380	380	370	400
	n [1/min]	17400	11900	7600	5500	4800	4200	3700	3300
Stahl < 1200 N/mm²	v _c [m/min]	50	50	50	50	50	50	50	50
	f [mm/U]	0,020	0,025	0,040	0,055	0,065	0,070	0,080	0,100
	v _f [mm/min]	290	250	260	250	260	250	250	270
	n [1/min]	14500	9900	6400	4500	4000	3500	3100	2700
INOX < 800 N/mm²	v _c [m/min]	30	30	30	30	30	30	30	30
	f [mm/U]	0,010	0,015	0,025	0,035	0,040	0,045	0,050	0,060
	v _f [mm/min]	90	90	100	90	100	90	100	100
	n [1/min]	8700	6000	3800	2700	2400	2100	1900	1600
INOX > 800 N/mm²	v _c [m/min]	25	25	25	25	25	25	25	25
	f [mm/U]	0,010	0,015	0,025	0,035	0,040	0,045	0,050	0,060
	v _f [mm/min]	70	80	80	80	80	80	80	80
	n [1/min]	7200	5000	3200	2300	2000	1800	1600	1400
GG	v _c [m/min]	65	65	65	65	65	65	65	65
	f [mm/U]	0,025	0,030	0,050	0,070	0,080	0,090	0,100	0,120
	v _f [mm/min]	470	390	420	410	420	410	410	430
	n [1/min]	18800	12900	8300	5900	5200	4600	4100	3600
Titan	v _c [m/min]	30	30	30	30	30	30	30	30
	f [mm/U]	0,010	0,015	0,025	0,035	0,040	0,045	0,050	0,060
	v _f [mm/min]	90	90	100	90	100	90	100	100
	n [1/min]	8700	6000	3800	2700	2400	2100	1900	1600
NE-Metalle Cu-Legierungen	v _c [m/min]	130	130	130	130	130	130	130	130
	f [mm/U]	0,035	0,055	0,090	0,100	0,120	0,130	0,140	0,160
	v _f [mm/min]	1320	1420	1490	1180	1240	1200	1130	1140
	n [1/min]	37600	25900	16600	11800	10300	9200	8100	7100
Graphit & Faserverbund	v _c [m/min]	50	50	50	50	50	50	50	50
	f [mm/U]	0,020	0,030	0,045	0,050	0,060	0,065	0,070	0,080
	v _f [mm/min]	290	300	290	230	240	230	220	160
	n [1/min]	14500	9900	6400	4500	4000	3500	3100	2700

HAM 30-1301

Vollhartmetall-Spiralbohrer
solid carbide spiral drill

VHM Z2 30° rechts Werk Norm
 Typ N 140° HA
 HPC SHRINK FIT

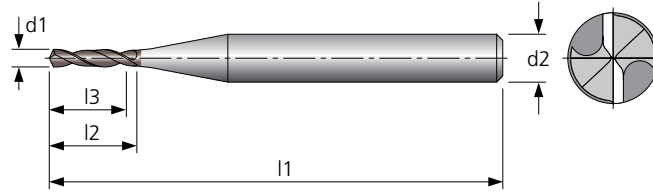

Material	Alu Knet-leg.	Alu Guss-leg.	Stahl < 800 N/mm²	Stahl < 1200 N/mm²	Stahl < 1600 N/mm²	Stahl < 55 HRC	Stahl < 60 HRC	Stahl < 66 HRC	INOX < 800 N/mm²	INOX > 800 N/mm²	GG	GGG	hochw. Legierungen	Titan	NE-Metalle Cu-Leg.	Graphit & Faser-verbund	MMS	max.	ohne	AIR	
30-1301			●	●	●	○			●	○	●	●		●				●	●	○	○

● sehr gut geeignet / very suitable ○ bedingt geeignet / limited suitable

HAM 30-1301

Werkstoffgruppe material group	Ø mm	0,1 – 0,35	0,4 – 0,65	0,7 – 0,95	1 – 1,15	1,2 – 1,45	1,5 – 1,95	2 – 2,45	2,5 – 3
Stahl < 800 N/mm²	V _c [m/min]	90	90	90	90	90	90	90	90
	f [mm/U]	0,010	0,020	0,040	0,050	0,070	0,090	0,120	0,150
	V _f [mm/min]	500	1000	1350	1300	1480	1480	1500	1530
	n [1/min]	min. 50000	min. 50000	33700	26000	21200	16400	12500	10200
Stahl < 1200 N/mm²	V _c [m/min]	70	70	70	70	70	70	70	70
	f [mm/U]	0,010	0,020	0,040	0,050	0,070	0,090	0,120	0,150
	V _f [mm/min]	500	810	1050	1020	1160	1140	1160	1200
	n [1/min]	min. 50000	40500	26200	20300	16500	12700	9700	8000
Stahl < 1600 N/mm²	V _c [m/min]	50	50	50	50	50	50	50	50
	f [mm/U]	0,007	0,020	0,035	0,040	0,055	0,070	0,090	0,110
	V _f [mm/min]	350	580	650	580	650	640	620	630
	n [1/min]	min. 50000	28900	18700	14500	11800	9100	6900	5700
Stahl < 55 HRC	V _c [m/min]	35	35	35	35	35	35	35	35
	f [mm/U]	0,005	0,010	0,015	0,020	0,025	0,035	0,045	0,055
	V _f [mm/min]	250	200	200	200	210	220	220	220
	n [1/min]	min. 50000	20300	13100	10100	8300	6400	4800	4000
INOX < 800 N/mm²	V _c [m/min]	40	40	40	40	40	40	40	40
	f [mm/U]	0,004	0,008	0,012	0,015	0,020	0,025	0,035	0,040
	V _f [mm/min]	200	180	180	170	190	180	190	180
	n [1/min]	min. 50000	23100	15000	11600	9400	7300	5500	4500
INOX > 800 N/mm²	V _c [m/min]	30	30	30	30	30	30	30	30
	f [mm/U]	0,004	0,008	0,012	0,015	0,020	0,025	0,035	0,040
	V _f [mm/min]	190	140	130	130	140	140	150	140
	n [1/min]	47700	17400	11200	8700	7100	5500	4200	3400
GG	V _c [m/min]	85	85	85	85	85	85	85	85
	f [mm/U]	0,010	0,020	0,040	0,050	0,070	0,090	0,120	0,150
	V _f [mm/min]	500	980	1270	1230	1400	1400	1420	1460
	n [1/min]	min. 50000	49200	31800	24600	20000	15500	11800	9700
GGG	V _c [m/min]	65	65	65	65	65	65	65	65
	f [mm/U]	0,010	0,020	0,040	0,050	0,070	0,090	0,120	0,150
	V _f [mm/min]	500	750	970	940	1070	1060	1080	1110
	n [1/min]	min. 50000	37600	24300	18800	15300	11800	9000	7400
Titan	V _c [m/min]	35	35	35	35	35	35	35	35
	f [mm/U]	0,004	0,008	0,012	0,015	0,020	0,025	0,035	0,040
	V _f [mm/min]	200	160	160	150	170	160	170	160
	n [1/min]	min. 50000	20300	13100	10100	8300	6400	4800	4000

HAM 30-1320

Vollhartmetall-Spiralbohrer
solid carbide spiral drill

VHM Z 2 30° rechts DIN 6539
Typ N HA

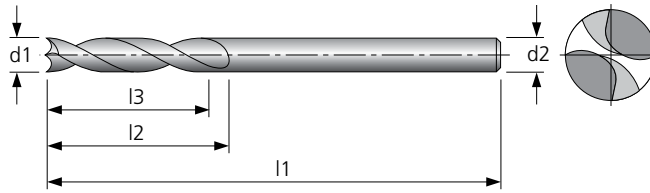

Material	Alu Knet-leg.	Alu Guss-leg.	Stahl < 800 N/mm²	Stahl < 1200 N/mm²	Stahl < 1600 N/mm²	Stahl < 55 HRC	Stahl < 60 HRC	Stahl < 66 HRC	INOX < 800 N/mm²	INOX > 800 N/mm²	GG	GGG	hochw. Legierungen	Titan	NE-Metalle Cu-Leg.	Graphit & Faser-verbund	MMS	max.	ohne	AIR
30-1320	○	○													○	●	●	●	●	●

● sehr gut geeignet / very suitable ○ bedingt geeignet / limited suitable

HAM 30-1320

Werkstoffgruppe material group	Ø mm	3 – 3,7	4 – 4,7	5 – 5,3	5,5 – 6	6,5 – 7,5	8 – 9,5	10 – 10,5	11 – 11,5	12 – 13	14 – 16
Alu Knetlegierungen	v _c [m/min]	200	200	200	200	200	200	200	200	200	200
	f [mm/U]	0,180	0,230	0,270	0,350	0,400	0,450	0,500	0,550	0,650	0,650
	v _f [mm/min]	3280	3240	3240	3710	3640	3200	3050	3030	3190	2730
	n [1/min]	18200	14100	12000	10600	9100	7100	6100	5500	4900	4200
Alu Gusslegierungen	v _c [m/min]	150	150	150	150	150	150	150	150	150	150
	f [mm/U]	0,120	0,150	0,180	0,230	0,250	0,300	0,350	0,400	0,450	0,450
	v _f [mm/min]	1630	1590	1620	1840	1700	1590	1580	1680	1670	1440
	n [1/min]	13600	10600	9000	8000	6800	5300	4500	4200	3700	3200
NE-Metalle Cu-Legierungen	v _c [m/min]	100	100	100	100	100	100	100	100	100	100
	f [mm/U]	0,080	0,100	0,120	0,150	0,170	0,200	0,240	0,270	0,300	0,300
	v _f [mm/min]	730	710	720	800	770	700	720	760	720	630
	n [1/min]	9100	7100	6000	5300	4500	3500	3000	2800	2400	2100
Graphit & Faserverbund	v _c [m/min]	60	60	60	60	60	60	60	60	60	60
	f [mm/U]	0,045	0,050	0,060	0,070	0,080	0,090	0,100	0,120	0,150	0,150
	v _f [mm/min]	250	210	220	220	220	190	180	200	230	200
	n [1/min]	5500	4200	3600	3200	2700	2100	1800	1700	1500	1300

HAM 30-1621 / 1701
Superdrill

Vollhartmetall-Spiralbohrer
solid carbide spiral drill

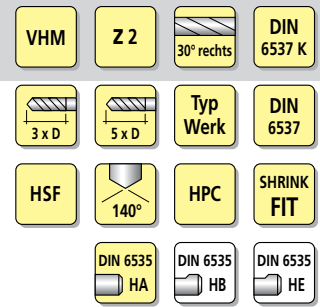
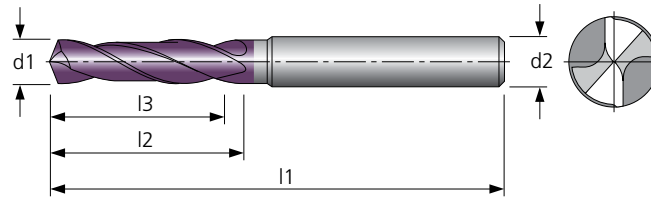

Material	Alu Knet-leg.	Alu Guss-leg.	Stahl < 800 N/mm²	Stahl < 1200 N/mm²	Stahl < 1600 N/mm²	Stahl < 55 HRC	Stahl < 60 HRC	Stahl < 66 HRC	INOX < 800 N/mm²	INOX > 800 N/mm²	GG	GGG	hochw. Legierungen	Titan	NE-Metalle Cu-Leg.	Graphit & Faser-verbund	MMS	max.	ohne	AIR
30-1621 / 30-1701			●	●	●	●			○	○	●	●	○	○			●	●	○	○

● sehr gut geeignet / very suitable ○ bedingt geeignet / limited suitable

HAM 30-1621 / 30-1701

Werkstoffgruppe material group	Ø mm	3	4	5	6	8	10	12	14	16	18	20
Stahl < 800 N/mm²	V _c [m/min]	90	90	90	90	90	90	90	90	90	90	90
	f [mm/U]	0,100	0,150	0,180	0,200	0,250	0,300	0,350	0,350	0,400	0,450	0,500
	V _f [mm/min]	950	1080	1030	960	900	870	840	700	720	720	700
	n [1/min]	9500	7200	5700	4800	3600	2900	2400	2000	1800	1600	1400
Stahl < 1200 N/mm²	V _c [m/min]	65	65	65	65	65	65	65	65	65	65	65
	f [mm/U]	0,100	0,150	0,180	0,200	0,250	0,300	0,350	0,350	0,400	0,450	0,500
	V _f [mm/min]	690	780	740	680	650	630	600	530	520	500	500
	n [1/min]	6900	5200	4100	3400	2600	2100	1700	1500	1300	1100	1000
Stahl < 1600 N/mm²	V _c [m/min]	50	50	50	50	50	50	50	50	50	50	50
	f [mm/U]	0,080	0,120	0,150	0,180	0,200	0,250	0,300	0,300	0,350	0,400	0,450
	V _f [mm/min]	420	480	480	490	400	400	390	330	350	360	360
	n [1/min]	5300	4000	3200	2700	2000	1600	1300	1100	1000	900	800
Stahl < 55 HRC	V _c [m/min]	12	12	12	12	12	12	12	12	12	12	12
	f [mm/U]	0,010	0,020	0,030	0,040	0,050	0,060	0,070	0,080	0,090	0,100	0,120
	V _f [mm/min]	10	20	20	20	30	20	20	20	20	20	20
	n [1/min]	1300	1000	800	600	500	400	300	300	200	200	200
INOX < 800 N/mm²	V _c [m/min]	35	35	35	35	35	35	35	35	35	35	35
	f [mm/U]	0,030	0,040	0,050	0,060	0,080	0,100	0,120	0,130	0,150	0,180	0,200
	V _f [mm/min]	110	110	110	110	110	110	110	100	110	110	120
	n [1/min]	3700	2800	2200	1900	1400	1100	900	800	700	600	600
INOX > 800 N/mm²	V _c [m/min]	25	25	25	25	25	25	25	25	25	25	25
	f [mm/U]	0,030	0,040	0,050	0,060	0,080	0,100	0,120	0,130	0,150	0,180	0,200
	V _f [mm/min]	80	80	80	80	80	80	80	80	80	70	80
	n [1/min]	2700	2000	1600	1300	1000	800	700	600	500	400	400
GG	V _c [m/min]	85	85	85	85	85	85	85	85	85	85	85
	f [mm/U]	0,100	0,120	0,150	0,200	0,250	0,350	0,450	0,500	0,600	0,650	0,700
	V _f [mm/min]	900	820	810	900	850	950	1040	950	1020	980	980
	n [1/min]	9000	6800	5400	4500	3400	2700	2300	1900	1700	1500	1400
GGG	V _c [m/min]	65	65	65	65	65	65	65	65	65	65	65
	f [mm/U]	0,060	0,100	0,120	0,130	0,180	0,200	0,250	0,250	0,250	0,280	0,300
	V _f [mm/min]	410	520	490	440	470	420	430	380	330	310	300
	n [1/min]	6900	5200	4100	3400	2600	2100	1700	1500	1300	1100	1000
hochwärmfeste Legierungen	V _c [m/min]	40	40	40	40	40	40	40	40	40	40	40
	f [mm/U]	0,030	0,040	0,040	0,050	0,070	0,100	0,120	0,130	0,140	0,150	0,160
	V _f [mm/min]	130	130	100	110	110	130	130	120	110	110	100
	n [1/min]	4200	3200	2500	2100	1600	1300	1100	900	800	700	600
Titan	V _c [m/min]	25	25	25	25	25	25	25	25	25	25	25
	f [mm/U]	0,020	0,030	0,040	0,050	0,060	0,070	0,080	0,100	0,100	0,110	0,120
	V _f [mm/min]	50	60	60	70	60	60	60	60	50	40	50
	n [1/min]	2700	2000	1600	1300	1000	800	700	600	500	400	400

Bei den Werkstoffgruppen INOX < 800 N/mm², INOX > 800 N/mm² und Titan empfehlen wir den Einsatz unseres HAM Nirodrill.

We recommend to use our solid carbide high performance drill HAM Nirodrill for material INOX < 800 N/mm², INOX > 800 N/mm² and Titanium.

HAM 30-1741 / 1781 / 1821
Superdrill

Vollhartmetall-Spiralbohrer
solid carbide spiral drill

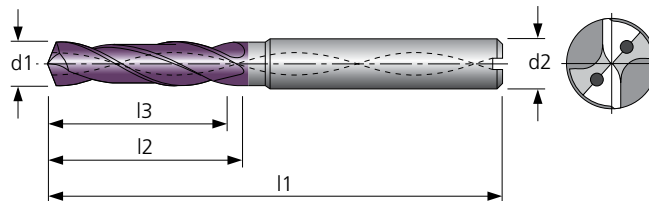

VHM	Z 2	30° rechts	DIN 6537 K
3 x D	5 x D	8 x D	DIN 6537
HSF	Typ Werk	140°	Werk Norm
	HPC	SHRINK FIT	
DIN 6535 HAK	DIN 6535 HBK	DIN 6535 HEK	

Material	Alu Knet-leg.	Alu Guss-leg.	Stahl < 800 N/mm²	Stahl < 1200 N/mm²	Stahl < 1600 N/mm²	Stahl < 55 HRC	Stahl < 60 HRC	Stahl < 66 HRC	INOX < 800 N/mm²	INOX > 800 N/mm²	GG	GGG	hochw. Legierungen	Titan	NE-Metalle Cu-Leg.	Graphit & Faser-verbund	MMS	max.	ohne	AIR
30-1741 / 1781 / 1821			●	●	●	●			○	○	●	●	○	○			●	●	○	○

● sehr gut geeignet / very suitable ○ bedingt geeignet / limited suitable

HAM 30-1741 / 30-1781 / 30-1821

Werkstoffgruppe material group	Ø mm	3	4	5	6	8	10	12	14	16	18	20	22
Stahl < 800 N/mm²	V _c [m/min]	130	130	130	130	130	130	130	130	130	130	130	130
	f [mm/U]	0,120	0,170	0,200	0,220	0,270	0,320	0,370	0,400	0,450	0,500	0,550	0,600
	V _f [mm/min]	1660	1750	1660	1520	1400	1310	1260	1200	1170	1150	1160	1140
	n [1/min]	13800	10300	8300	6900	5200	4100	3400	3000	2600	2300	2100	1900
Stahl < 1200 N/mm²	V _c [m/min]	90	90	90	90	90	90	90	90	90	90	90	90
	f [mm/U]	0,120	0,170	0,200	0,220	0,270	0,320	0,370	0,400	0,450	0,500	0,550	0,600
	V _f [mm/min]	1140	1220	1140	1060	970	930	890	800	810	800	770	780
	n [1/min]	9500	7200	5700	4800	3600	2900	2400	2000	1800	1600	1400	1300
Stahl < 1600 N/mm²	V _c [m/min]	70	70	70	70	70	70	70	70	70	70	70	70
	f [mm/U]	0,100	0,140	0,170	0,200	0,220	0,270	0,320	0,350	0,370	0,400	0,470	0,500
	V _f [mm/min]	740	780	770	740	620	590	610	560	520	480	520	500
	n [1/min]	7400	5600	4500	3700	2800	2200	1900	1600	1400	1200	1100	1000
Stahl < 55 HRC	V _c [m/min]	15	15	15	15	15	15	15	15	15	15	15	15
	f [mm/U]	0,010	0,020	0,030	0,040	0,050	0,060	0,070	0,080	0,090	0,100	0,120	0,140
	V _f [mm/min]	20	20	30	30	30	30	30	30	20	30	20	30
	n [1/min]	1600	1200	1000	800	600	500	400	300	300	300	200	200
INOX < 800 N/mm²	V _c [m/min]	40	40	40	40	40	40	40	40	40	40	40	40
	f [mm/U]	0,030	0,040	0,050	0,060	0,070	0,080	0,100	0,110	0,120	0,140	0,160	0,200
	V _f [mm/min]	130	130	130	130	110	100	110	100	100	100	100	120
	n [1/min]	4200	3200	2500	2100	1600	1300	1100	900	800	700	600	600
INOX > 800 N/mm²	V _c [m/min]	30	30	30	30	30	30	30	30	30	30	30	30
	f [mm/U]	0,015	0,020	0,025	0,030	0,040	0,050	0,060	0,070	0,080	0,090	0,100	0,120
	V _f [mm/min]	50	50	50	50	50	50	50	50	50	50	50	50
	n [1/min]	3200	2400	1900	1600	1200	1000	800	700	600	500	500	400
GG	V _c [m/min]	120	120	120	120	120	120	120	120	120	120	120	120
	f [mm/U]	0,120	0,140	0,170	0,220	0,270	0,370	0,450	0,500	0,620	0,650	0,720	0,750
	V _f [mm/min]	1520	1330	1290	1410	1300	1410	1440	1350	1490	1370	1370	1280
	n [1/min]	12700	9500	7600	6400	4800	3800	3200	2700	2400	2100	1900	1700
GGG	V _c [m/min]	90	90	90	90	90	90	90	90	90	90	90	90
	f [mm/U]	0,060	0,100	0,120	0,130	0,180	0,200	0,250	0,250	0,250	0,250	0,300	0,350
	V _f [mm/min]	570	720	680	620	650	580	600	500	450	400	420	460
	n [1/min]	9500	7200	5700	4800	3600	2900	2400	2000	1800	1600	1400	1300
hochwärmefeste Legierungen	V _c [m/min]	50	50	50	50	50	50	50	50	50	50	50	50
	f [mm/U]	0,040	0,050	0,060	0,070	0,090	0,120	0,140	0,150	0,160	0,170	0,180	0,200
	V _f [mm/min]	210	200	190	190	180	190	180	170	160	150	140	140
	n [1/min]	5300	4000	3200	2700	2000	1600	1300	1100	1000	900	800	700
Titan	V _c [m/min]	30	30	30	30	30	30	30	30	30	30	30	30
	f [mm/U]	0,015	0,020	0,025	0,030	0,040	0,050	0,060	0,070	0,080	0,090	0,100	0,120
	V _f [mm/min]	50	50	50	50	50	50	50	50	50	50	50	50
	n [1/min]	3200	2400	1900	1600	1200	1000	800	700	600	500	500	400

Bei den Werkstoffgruppen INOX < 800 N/mm², INOX > 800 N/mm² und Titan empfehlen wir den Einsatz unseres HAM Nirodrill.

We recommend to use our solid carbide high performance drill HAM Nirodrill for material INOX < 800 N/mm², INOX > 800 N/mm² and Titanium.

HAM 30-1861
Superdrill

Vollhartmetall-Spiralbohrer
solid carbide spiral drill

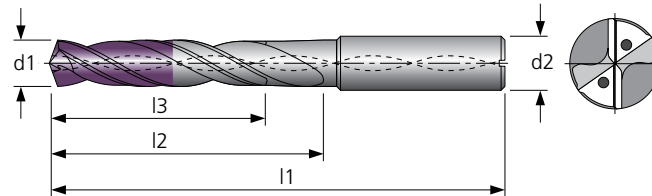

VHM **Z 2** **30° rechts** **Werk Norm**
12 x D **Typ Werk** **140°** **DIN 6535 HAK**
HSF **HPC** **SHRINK FIT**
DIN 6535 HBK **DIN 6535 HEK**

Material	Alu Knet-leg.	Alu Guss-leg.	Stahl < 800 N/mm²	Stahl < 1200 N/mm²	Stahl < 1600 N/mm²	Stahl < 55 HRC	Stahl < 60 HRC	Stahl < 66 HRC	INOX < 800 N/mm²	INOX > 800 N/mm²	GG	GGG	hochw. Legierungen	Titan	NE-Metalle Cu-Leg.	Graphit & Faser-verbund	MMS	max.	ohne	AIR
30-1861			●	●	●	●			○	○	●	●	○	○			●	●	○	○

● sehr gut geeignet / very suitable ○ bedingt geeignet / limited suitable

HAM 30-1861

Werkstoffgruppe material group	Ø mm	3	4	5	6	8	10	12
Stahl < 800 N/mm²	V _c [m/min]	115	115	115	115	115	115	115
	f [mm/U]	0,090	0,135	0,160	0,180	0,220	0,270	0,300
	V _f [mm/min]	1100	1240	1170	1100	1010	1000	930
	n [1/min]	12200	9200	7300	6100	4600	3700	3100
Stahl < 1200 N/mm²	V _c [m/min]	80	80	80	80	80	80	80
	f [mm/U]	0,090	0,135	0,160	0,180	0,220	0,270	0,300
	V _f [mm/min]	770	860	820	760	700	680	630
	n [1/min]	8500	6400	5100	4200	3200	2500	2100
Stahl < 1600 N/mm²	V _c [m/min]	60	60	60	60	60	60	60
	f [mm/U]	0,070	0,100	0,130	0,160	0,180	0,220	0,270
	V _f [mm/min]	450	480	490	510	430	420	430
	n [1/min]	6400	4800	3800	3200	2400	1900	1600
Stahl < 55 HRC	V _c [m/min]	10	10	10	10	10	10	10
	f [mm/U]	0,010	0,020	0,030	0,040	0,050	0,060	0,070
	V _f [mm/min]	10	20	20	20	20	20	20
	n [1/min]	1100	800	600	500	400	300	300
INOX < 800 N/mm²	V _c [m/min]	35	35	35	35	35	35	35
	f [mm/U]	0,025	0,035	0,045	0,050	0,070	0,090	0,100
	V _f [mm/min]	90	100	100	100	100	100	90
	n [1/min]	3700	2800	2200	1900	1400	1100	900
INOX > 800 N/mm²	V _c [m/min]	25	25	25	25	25	25	25
	f [mm/U]	0,025	0,035	0,045	0,050	0,070	0,090	0,100
	V _f [mm/min]	70	70	70	70	70	70	70
	n [1/min]	2700	2000	1600	1300	1000	800	700
GG	V _c [m/min]	100	100	100	100	100	100	100
	f [mm/U]	0,090	0,100	0,130	0,180	0,220	0,300	0,400
	V _f [mm/min]	950	800	830	950	880	960	1080
	n [1/min]	10600	8000	6400	5300	4000	3200	2700
GGG	V _c [m/min]	80	80	80	80	80	80	80
	f [mm/U]	0,050	0,090	0,100	0,110	0,160	0,180	0,220
	V _f [mm/min]	430	580	510	460	510	450	460
	n [1/min]	8500	6400	5100	4200	3200	2500	2100
hochwärmfeste Legierungen	V _c [m/min]	45	45	45	45	45	45	45
	f [mm/U]	0,020	0,030	0,030	0,040	0,060	0,090	0,100
	V _f [mm/min]	100	110	90	100	110	130	120
	n [1/min]	4800	3600	2900	2400	1800	1400	1200
Titan	V _c [m/min]	25	25	25	25	25	25	25
	f [mm/U]	0,018	0,020	0,030	0,040	0,050	0,060	0,070
	V _f [mm/min]	50	40	50	50	50	50	50
	n [1/min]	2700	2000	1600	1300	1000	800	700

HAM 30-1891
Nirodrill

Vollhartmetall-Spiralbohrer
solid carbide spiral drill

VHM **Z 2** 30° rechts **Werk Norm**
 3 x D **Typ Werk** 140° **DIN 6535 HA**
HSF **HPC** **SHRINK FIT**
DIN 6535 HB **DIN 6535 HE**

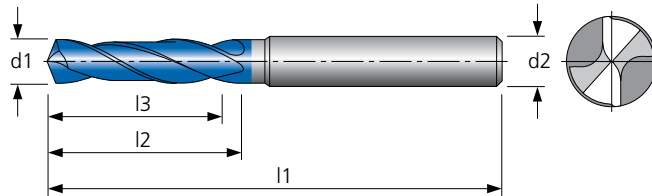

Material	Alu Knetleg.	Alu Gussleg.	Stahl < 800 N/mm²	Stahl < 1200 N/mm²	Stahl < 1600 N/mm²	Stahl < 55 HRC	Stahl < 60 HRC	Stahl < 66 HRC	INOX < 800 N/mm²	INOX > 800 N/mm²	GG	GGG	hochw. Legierungen	Titan	NE-Metalle Cu-Leg.	Graphit & Faserverbund	MMS	max.	ohne	AIR
30-1891	●	●							●	●	○		○	●	●	○	●	●	○	○

● sehr gut geeignet / very suitable ○ bedingt geeignet / limited suitable

HAM 30-1891		Ø mm	2	3	4	5	6	8	10	12	14	16
Werkstoffgruppe material group												
Alu Knetlegierungen	v _c [m/min]		240	240	240	240	240	240	240	240	240	240
	f [mm/U]		0,080	0,090	0,120	0,150	0,180	0,240	0,300	0,360	0,420	0,480
	v _f [mm/min]		3060	2300	2290	2300	2290	2280	2280	2300	2310	2300
	n [1/min]		38200	25500	19100	15300	12700	9500	7600	6400	5500	4800
Alu Gusslegierungen	v _c [m/min]		200	200	200	200	200	200	200	200	200	200
	f [mm/U]		0,070	0,080	0,110	0,140	0,170	0,230	0,290	0,350	0,410	0,470
	v _f [mm/min]		2230	1700	1750	1780	1800	1840	1860	1860	1850	1880
	n [1/min]		31800	21200	15900	12700	10600	8000	6400	5300	4500	4000
INOX < 800 N/mm²	v _c [m/min]		50	50	50	50	50	50	50	50	50	50
	f [mm/U]		0,030	0,040	0,050	0,055	0,060	0,080	0,100	0,120	0,150	0,200
	v _f [mm/min]		240	210	200	180	160	160	160	160	170	200
	n [1/min]		8000	5300	4000	3200	2700	2000	1600	1300	1100	1000
INOX > 800 N/mm²	v _c [m/min]		35	35	35	35	35	35	35	35	35	35
	f [mm/U]		0,020	0,025	0,030	0,035	0,040	0,060	0,080	0,100	0,120	0,150
	v _f [mm/min]		110	90	80	80	80	80	90	90	100	110
	n [1/min]		5600	3700	2800	2200	1900	1400	1100	900	800	700
GG	v _c [m/min]		80	80	80	80	80	80	80	80	80	80
	f [mm/U]		0,080	0,090	0,120	0,150	0,180	0,240	0,300	0,360	0,420	0,470
	v _f [mm/min]		1020	770	770	770	760	770	750	760	760	750
	n [1/min]		12700	8500	6400	5100	4200	3200	2500	2100	1800	1600
hochwarmfeste Legierungen	v _c [m/min]		40	40	40	40	40	40	40	40	40	40
	f [mm/U]		0,020	0,030	0,045	0,050	0,060	0,080	0,090	0,110	0,120	0,150
	v _f [mm/min]		130	130	140	130	130	130	120	120	110	120
	n [1/min]		6400	4200	3200	2500	2100	1600	1300	1100	900	800
Titan	v _c [m/min]		35	35	35	35	35	35	35	35	35	35
	f [mm/U]		0,020	0,030	0,040	0,050	0,060	0,070	0,080	0,100	0,120	0,140
	v _f [mm/min]		110	110	110	110	110	100	90	90	100	100
	n [1/min]		5600	3700	2800	2200	1900	1400	1100	900	800	700
NE-Metalle Cu-Legierungen	v _c [m/min]		120	120	120	120	120	120	120	120	120	120
	f [mm/U]		0,070	0,080	0,100	0,120	0,150	0,180	0,220	0,260	0,300	0,400
	v _f [mm/min]		1340	1020	950	910	960	860	840	830	810	960
	n [1/min]		19100	12700	9500	7600	6400	4800	3800	3200	2700	2400
Graphit & Faserverbund	v _c [m/min]		35	35	35	35	35	35	35	35	35	35
	f [mm/U]		0,040	0,050	0,060	0,070	0,080	0,100	0,120	0,150	0,180	0,200
	v _f [mm/min]		220	190	170	150	150	140	130	140	140	140
	n [1/min]		5600	3700	2800	2200	1900	1400	1100	900	800	700

HAM 30-1881 / 1901 / 1941
Nirodrill

Vollhartmetall-Spiralbohrer
solid carbide spiral drill

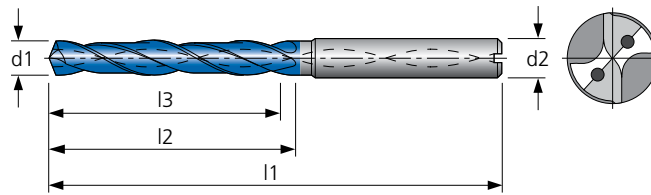

VHM	Z 2	30° rechts	DIN 6537 K
3 x D	5 x D	8 x D	DIN 6537
HSF	Typ Werk	140°	Werk Norm
	HPC	SHRINK FIT	
DIN 6535 HAK	DIN 6535 HBK	DIN 6535 HEK	

Material	Alu Knetleg.	Alu Gussleg.	Stahl < 800 N/mm²	Stahl < 1200 N/mm²	Stahl < 1600 N/mm²	Stahl < 55 HRC	Stahl < 60 HRC	Stahl < 66 HRC	INOX < 800 N/mm²	INOX > 800 N/mm²	GG	GGG	hochw. Legierungen	Titan	NE-Metalle Cu-Leg.	Graphit & Faserverbund	MMS	max.	ohne	AIR
30-1881 / 1901 / 1941	●	●							●	●	○		○	○	●	○	●	●		○

● sehr gut geeignet / very suitable ○ bedingt geeignet / limited suitable

HAM 30-1881 / 30-1901 / 30-1941

Werkstoffgruppe material group	Ø mm	3	4	5	6	8	10	12	14	16
Alu Knetlegierungen	v _c [m/min]	300	300	300	300	300	300	300	300	300
	f [mm/U]	0,120	0,180	0,200	0,250	0,300	0,400	0,500	0,600	0,800
	v _f [mm/min]	3820	4300	3820	3980	3570	3800	4000	4080	4800
	n [1/min]	31800	23900	19100	15900	11900	9500	8000	6800	6000
Alu Gusslegierungen	v _c [m/min]	250	250	250	250	250	250	250	250	250
	f [mm/U]	0,100	0,150	0,180	0,250	0,300	0,350	0,400	0,500	0,600
	v _f [mm/min]	2650	2990	2860	3330	2970	2800	2640	2850	3000
	n [1/min]	26500	19900	15900	13300	9900	8000	6600	5700	5000
INOX < 800 N/mm²	v _c [m/min]	70	70	70	70	70	70	70	70	70
	f [mm/U]	0,040	0,050	0,055	0,060	0,080	0,100	0,120	0,150	0,200
	v _f [mm/min]	300	280	250	220	220	230	230	240	280
	n [1/min]	7400	5600	4400	3700	2800	2200	1900	1600	1400
INOX > 800 N/mm²	v _c [m/min]	45	45	45	45	45	45	45	45	45
	f [mm/U]	0,025	0,030	0,035	0,040	0,060	0,080	0,100	0,120	0,150
	v _f [mm/min]	120	110	100	100	110	110	120	120	140
	n [1/min]	4700	3600	2800	2400	1800	1400	1200	1000	900
GG	v _c [m/min]	120	120	120	120	120	120	120	120	120
	f [mm/U]	0,100	0,150	0,180	0,200	0,250	0,300	0,350	0,420	0,500
	v _f [mm/min]	1270	1430	1370	1280	1200	1140	1120	1130	1200
	n [1/min]	12700	9500	7600	6400	4800	3800	3200	2700	2400
hochwarmfeste Legierungen	v _c [m/min]	50	50	50	50	50	50	50	50	50
	f [mm/U]	0,030	0,045	0,050	0,060	0,080	0,090	0,110	0,120	0,150
	v _f [mm/min]	160	180	160	160	160	140	140	130	150
	n [1/min]	5300	4000	3200	2700	2000	1600	1300	1100	1000
Titan	v _c [m/min]	50	50	50	50	50	50	50	50	50
	f [mm/U]	0,030	0,040	0,050	0,060	0,070	0,080	0,100	0,120	0,140
	v _f [mm/min]	160	160	160	160	140	130	130	130	140
	n [1/min]	5300	4000	3200	2650	2000	1600	1300	1100	1000
NE-Metalle Cu-Legierungen	v _c [m/min]	150	150	150	150	150	150	150	150	150
	f [mm/U]	0,080	0,100	0,120	0,150	0,180	0,220	0,260	0,300	0,400
	v _f [mm/min]	1250	1190	1150	1200	1080	1060	1040	1020	1200
	n [1/min]	16000	11900	9500	8000	6000	4800	4000	3400	3000
Graphit & Faserverbund	v _c [m/min]	50	50	50	50	50	50	50	50	50
	f [mm/U]	0,050	0,060	0,070	0,080	0,100	0,120	0,150	0,180	0,200
	v _f [mm/min]	270	240	230	220	200	190	200	200	200
	n [1/min]	5300	4000	3200	2700	2000	1600	1300	1100	1000

HAM 30-1941

Bitte beachten / please note:

v_c = 100 %

f = 85 %

HAM 30-2181 / 2221 / 2261

Vollhartmetall-Tieflochbohrer
solid carbide deep hole drill

VHM Z 2 30° rechts Werk Norm
5 x D 8 x D 12 x D
HSF Typ Werk 135°
HPC SHRINK FIT
HA

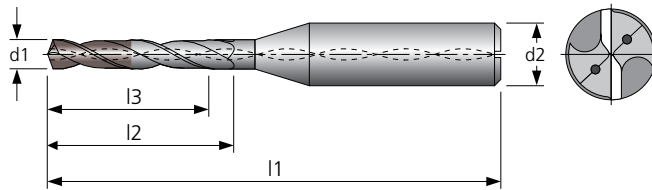

Material	Alu Knet-leg.	Alu Guss-leg.	Stahl < 800 N/mm²	Stahl < 1200 N/mm²	Stahl < 1600 N/mm²	Stahl < 55 HRC	Stahl < 60 HRC	Stahl < 66 HRC	INOX < 800 N/mm²	INOX > 800 N/mm²	GG	GGG	hochw. Legierungen	Titan	NE-Metalle Cu-Leg.	Graphit & Faserverbund	MMS	max.	ohne	AIR	
30-2181 / 2221 / 2261			●	●	○				●	○	●	●	○	○				●			

● sehr gut geeignet / very suitable ○ bedingt geeignet / limited suitable

HAM 30-2181 / 30-2221 / 30-2261

Werkstoffgruppe material group	Ø mm	0,8 – 0,95	1 – 1,2	1,25 – 1,45	1,5 – 1,7	1,75 – 1,95	2 – 2,2	2,25 – 2,45	2,5 – 2,7	2,75 – 3
Stahl < 800 N/mm²	V _c [m/min]	100	100	100	100	100	100	100	100	100
	f [mm/U]	0,040	0,050	0,060	0,080	0,100	0,120	0,120	0,140	0,160
	V _f [mm/min]	1420	1450	1420	1590	1720	1820	1620	1710	1760
	n [1/min]	35400	28900	23600	19900	17200	15200	13500	12200	11000
Stahl < 1200 N/mm²	V _c [m/min]	70	70	70	70	70	70	70	70	70
	f [mm/U]	0,020	0,030	0,040	0,040	0,060	0,080	0,100	0,120	0,140
	V _f [mm/min]	500	610	660	560	720	850	950	1030	1080
	n [1/min]	24800	20300	16500	13900	12000	10600	9500	8600	7700
Stahl < 1600 N/mm²	V _c [m/min]	55	55	55	55	55	55	55	55	55
	f [mm/U]	0,020	0,030	0,060	0,060	0,080	0,080	0,100	0,100	0,120
	V _f [mm/min]	390	480	780	650	760	660	740	670	720
	n [1/min]	19500	15900	13000	10900	9500	8300	7400	6700	6000
INOX < 800 N/mm²	V _c [m/min]	35	35	35	35	35	35	35	35	35
	f [mm/U]	0,020	0,020	0,030	0,040	0,050	0,060	0,070	0,080	0,100
	V _f [mm/min]	250	200	250	280	300	320	330	340	380
	n [1/min]	12400	10100	8300	7000	6000	5300	4700	4300	3800
INOX > 800 N/mm²	V _c [m/min]	30	30	30	30	30	30	30	30	30
	f [mm/U]	0,020	0,020	0,030	0,040	0,050	0,060	0,070	0,080	0,100
	V _f [mm/min]	210	170	210	240	260	270	290	300	330
	n [1/min]	10600	8700	7100	6000	5200	4500	4100	3700	3300
GG	V _c [m/min]	100	100	100	100	100	100	100	100	100
	f [mm/U]	0,040	0,060	0,080	0,100	0,120	0,150	0,180	0,200	0,250
	V _f [mm/min]	1420	1730	1890	1990	2060	2280	2430	2440	2750
	n [1/min]	35400	28900	23600	19900	17200	15200	13500	12200	11000
GGG	V _c [m/min]	60	60	60	60	60	60	60	60	60
	f [mm/U]	0,040	0,060	0,080	0,100	0,120	0,150	0,180	0,200	0,250
	V _f [mm/min]	850	1040	1130	1190	1240	1370	1460	1460	1650
	n [1/min]	21200	17400	14100	11900	10300	9100	8100	7300	6600
hochwarmfeste Legierungen	V _c [m/min]	10	40	40	40	40	40	40	40	40
	f [mm/U]	0,020	0,020	0,020	0,040	0,050	0,060	0,080	0,100	0,120
	V _f [mm/min]	70	230	190	320	350	370	430	490	530
	n [1/min]	3500	11600	9400	8000	6900	6100	5400	4900	4400
Titan	V _c [m/min]	30	30	30	30	30	30	30	30	30
	f [mm/U]	0,020	0,020	0,030	0,040	0,050	0,060	0,070	0,080	0,100
	V _f [mm/min]	210	170	210	240	260	270	290	300	330
	n [1/min]	10600	8700	7100	6000	5200	4500	4100	3700	3300

Einsatzempfehlung für Tieflochbohrer: Pilotbohrung mit HAM 30-1301
 Recommendation for using the deep hole drills: drilling a pilot hole with HAM 30-1301

HAM 30-2301 / 2341

Vollhartmetall-Tieflochbohrer solid carbide deep hole drill

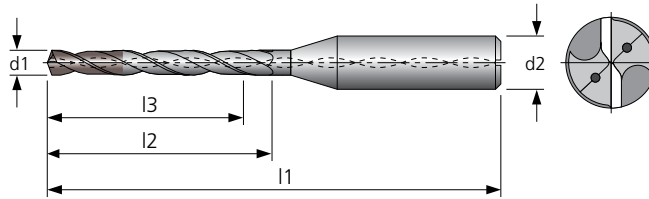
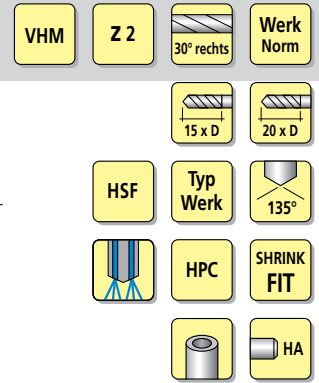

Material	Alu Knet-leg.	Alu Guss-leg.	Stahl < 800 N/mm²	Stahl < 1200 N/mm²	Stahl < 1600 N/mm²	Stahl < 55 HRC	Stahl < 60 HRC	Stahl < 66 HRC	INOX < 800 N/mm²	INOX > 800 N/mm²	GG	GGG	hochw. Legierungen	Titan	NE-Metalle Cu-Leg.	Graphit & Faserverbund	MMS	max.	ohne	AIR	
30-2301 / 30-2341			●	●	○				●	○	●	●	○	○				●			

● sehr gut geeignet / very suitable ○ bedingt geeignet / limited suitable

HAM 30-2301 / 30-2341

Werkstoffgruppe material group	Ø mm	0,8 – 0,95	1 – 1,2	1,25 – 1,45	1,5 – 1,7	1,75 – 1,95	2 – 2,2	2,25 – 2,45	2,5 – 2,7	2,75 – 3
Stahl < 800 N/mm²	v _c [m/min]	95	95	95	95	95	95	95	95	95
	f [mm/U]	0,030	0,040	0,050	0,070	0,090	0,110	0,110	0,130	0,150
	v _f [mm/min]	1010	1100	1120	1320	1470	1580	1420	1510	1560
	n [1/min]	33600	27500	22400	18900	16300	14400	12900	11600	10400
Stahl < 1200 N/mm²	v _c [m/min]	65	65	65	65	65	65	65	65	65
	f [mm/U]	0,015	0,025	0,035	0,035	0,050	0,070	0,090	0,110	0,130
	v _f [mm/min]	350	470	540	450	560	690	790	880	920
	n [1/min]	23000	18800	15300	12900	11200	9900	8800	8000	7100
Stahl < 1600 N/mm²	v _c [m/min]	50	50	50	50	50	50	50	50	50
	f [mm/U]	0,015	0,025	0,035	0,035	0,050	0,070	0,090	0,100	0,120
	v _f [mm/min]	270	360	410	350	430	530	610	610	660
	n [1/min]	17700	14500	11800	9900	8600	7600	6800	6100	5500
INOX < 800 N/mm²	v _c [m/min]	35	35	35	35	35	35	35	35	35
	f [mm/U]	0,010	0,015	0,018	0,030	0,040	0,050	0,070	0,090	0,100
	v _f [mm/min]	120	150	150	210	240	270	330	390	380
	n [1/min]	12400	10100	8300	7000	6000	5300	4700	4300	3800
INOX > 800 N/mm²	v _c [m/min]	30	30	30	30	30	30	30	30	30
	f [mm/U]	0,010	0,015	0,020	0,030	0,040	0,050	0,060	0,070	0,090
	v _f [mm/min]	110	130	140	180	210	230	250	260	300
	n [1/min]	10600	8700	7100	6000	5200	4500	4100	3700	3300
GG	v _c [m/min]	95	95	95	95	95	95	95	95	95
	f [mm/U]	0,040	0,050	0,070	0,100	0,100	0,120	0,150	0,180	0,200
	v _f [mm/min]	1340	1380	1570	1890	1630	1730	1940	2090	2080
	n [1/min]	33600	27500	22400	18900	16300	14400	12900	11600	10400
GGG	v _c [m/min]	55	55	55	55	55	55	55	55	55
	f [mm/U]	0,040	0,050	0,070	0,100	0,100	0,120	0,150	0,180	0,200
	v _f [mm/min]	780	800	910	1090	950	1000	1110	1210	1200
	n [1/min]	19500	15900	13000	10900	9500	8300	7400	6700	6000
hochwarmfeste Legierungen	v _c [m/min]	35	35	35	35	35	35	35	35	35
	f [mm/U]	0,010	0,015	0,018	0,030	0,040	0,050	0,070	0,090	0,100
	v _f [mm/min]	120	150	150	210	240	270	330	390	380
	n [1/min]	12400	10100	8300	7000	6000	5300	4700	4300	3800
Titan	v _c [m/min]	25	25	25	25	25	25	25	25	25
	f [mm/U]	0,010	0,015	0,020	0,030	0,040	0,050	0,060	0,070	0,090
	v _f [mm/min]	90	110	120	150	170	190	200	220	240
	n [1/min]	8800	7200	5900	5000	4300	3800	3400	3100	2700

Einsatzempfehlung für Tieflochbohrer: Pilotbohrung mit HAM 30-1301
 Recommendation for using the deep hole drills: drilling a pilot hole with HAM 30-1301

**HAM 30-2381 / 2421 / 2461
30-2501 / 2541**

Vollhartmetall-Tieflochbohrer
solid carbide deep hole drill

VHM Z 2 30° rechts Werk Norm

15 x D 20 x D 25 x D 30 x D 40 x D

HSF Typ Werk 137°

HPC SHRINK FIT

DIN 6535 BHAK

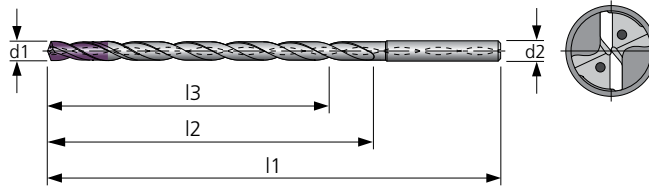

Material	Alu Knet-leg.	Alu Guss-leg.	Stahl < 800 N/mm²	Stahl < 1200 N/mm²	Stahl < 1600 N/mm²	Stahl < 55 HRC	Stahl < 60 HRC	Stahl < 66 HRC	INOX < 800 N/mm²	INOX > 800 N/mm²	GG	GGG	hochw. Legierungen	Titan	NE-Metalle Cu-Leg.	Graphit & Faser-verbund	MMS	max.	ohne	AIR	
30-2381 / 2421 / 2461 30-2501 / 2541			●	●	○				●	○	●	●	○	○				●			

● sehr gut geeignet / very suitable ○ bedingt geeignet / limited suitable

HAM 30-2381 / 30-2421 / 30-2461 / 30-2501 / 30-2541

Werkstoffgruppe material group	Ø mm	3	4	5	6	8	10	12	14
Stahl < 800 N/mm²	v _c [m/min]	60	60	60	60	60	60	60	60
	f [mm/U]	0,080	0,100	0,150	0,200	0,250	0,300	0,350	0,450
	v _f [mm/min]	510	480	570	640	600	570	560	630
	n [1/min]	6400	4800	3800	3200	2400	1900	1600	1400
Stahl < 1200 N/mm²	v _c [m/min]	50	50	50	50	50	50	50	50
	f [mm/U]	0,080	0,100	0,150	0,200	0,250	0,300	0,350	0,450
	v _f [mm/min]	420	400	480	540	500	480	460	500
	n [1/min]	5300	4000	3200	2700	2000	1600	1300	1100
Stahl < 1600 N/mm²	v _c [m/min]	40	40	40	40	40	40	40	40
	f [mm/U]	0,080	0,100	0,150	0,200	0,250	0,300	0,350	0,450
	v _f [mm/min]	340	320	380	420	400	390	390	410
	n [1/min]	4200	3200	2500	2100	1600	1300	1100	900
INOX < 800 N/mm²	v _c [m/min]	30	30	30	30	30	30	30	30
	f [mm/U]	0,040	0,050	0,060	0,070	0,080	0,090	0,100	0,110
	v _f [mm/min]	130	120	110	110	100	90	80	80
	n [1/min]	3200	2400	1900	1600	1200	1000	800	700
INOX > 800 N/mm²	v _c [m/min]	25	25	25	25	25	25	25	25
	f [mm/U]	0,040	0,050	0,060	0,070	0,080	0,090	0,100	0,110
	v _f [mm/min]	110	100	100	90	80	70	70	70
	n [1/min]	2700	2000	1600	1300	1000	800	700	600
GG	v _c [m/min]	60	60	60	60	60	60	60	60
	f [mm/U]	0,080	0,100	0,150	0,200	0,250	0,300	0,350	0,450
	v _f [mm/min]	510	480	570	640	600	570	560	630
	n [1/min]	6400	4800	3800	3200	2400	1900	1600	1400
GGG	v _c [m/min]	50	50	50	50	50	50	50	50
	f [mm/U]	0,080	0,100	0,150	0,200	0,250	0,300	0,350	0,450
	v _f [mm/min]	420	400	480	540	500	480	460	500
	n [1/min]	5300	4000	3200	2700	2000	1600	1300	1100
hochwarmfeste Legierungen	v _c [m/min]	40	40	40	40	40	40	40	40
	f [mm/U]	0,080	0,100	0,150	0,200	0,250	0,300	0,350	0,450
	v _f [mm/min]	340	320	380	420	400	390	390	410
	n [1/min]	4200	3200	2500	2100	1600	1300	1100	900
Titan	v _c [m/min]	20	20	20	20	20	20	20	20
	f [mm/U]	0,040	0,050	0,060	0,070	0,080	0,090	0,100	0,110
	v _f [mm/min]	80	80	80	80	60	50	50	60
	n [1/min]	2100	1600	1300	1100	800	600	500	500

Einsatzempfehlung für Tieflochbohrer: Pilotbohrung mit HAM 30-1741 oder HAM 30-1621
Recommendation for using the deep hole drills: drilling a pilot hole with HAM 30-1741 or HAM 30-1621

HAM 30-2580 / 2620 / 2660 30-2700 / 2740

Vollhartmetall-Tieflochbohrer
solid carbide deep hole drill

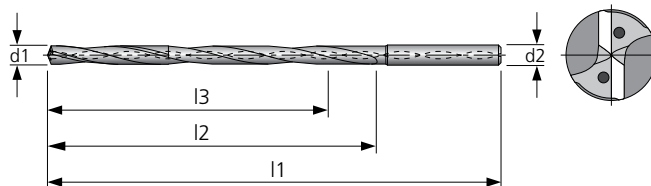
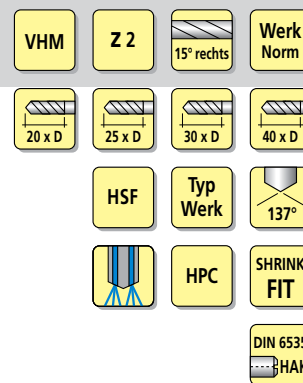

Material	Alu Knetleg.	Alu Gussleg.	Stahl < 800 N/mm²	Stahl < 1200 N/mm²	Stahl < 1600 N/mm²	Stahl < 55 HRC	Stahl < 60 HRC	Stahl < 66 HRC	INOX < 800 N/mm²	INOX > 800 N/mm²	GG	GGG	hochw. Legierungen	Titan	NE-Metalle Cu-Leg.	Graphit & Faserverbund	MMS	max.	ohne	AIR
30-2580 / 2620 / 2660 30-2700 / 2740	●	●													●			●		

● sehr gut geeignet / very suitable ○ bedingt geeignet / limited suitable

HAM 30-2580 / 30-2620 / 30-2660 / 30-2700 / 30-2740

Werkstoffgruppe material group	Ø mm	2	3	4	4,5	5	5,5	6
Alu Knetlegierungen	v _c [m/min]	135	135	135	135	180	180	220
	f [mm/U]	0,100	0,120	0,150	0,150	0,180	0,180	0,200
	v _f [mm/min]	2150	1720	1610	1430	2070	1870	2340
	n [1/min]	21500	14300	10700	9500	11500	10400	11700
Alu Gusslegierungen	v _c [m/min]	100	100	100	100	150	150	180
	f [mm/U]	0,080	0,100	0,120	0,120	0,200	0,200	0,250
	v _f [mm/min]	1270	1060	960	850	1900	1740	2380
	n [1/min]	15900	10600	8000	7100	9500	8700	9500
NE-Metalle Cu-Legierungen	v _c [m/min]	120	120	120	120	180	180	200
	f [mm/U]	0,080	0,100	0,100	0,100	0,200	0,200	0,250
	v _f [mm/min]	1530	1270	950	850	2300	2080	2650
	n [1/min]	19100	12700	9500	8500	11500	10400	10600

Werkstoffgruppe material group	Ø mm	6,5	7	8	8,5	10	12	14
Alu Knetlegierungen	v _c [m/min]	220	220	250	250	250	250	250
	f [mm/U]	0,200	0,200	0,300	0,300	0,350	0,400	0,500
	v _f [mm/min]	2160	2000	2970	2820	2800	2640	2850
	n [1/min]	10800	10000	9900	9400	8000	6600	5700
Alu Gusslegierungen	v _c [m/min]	180	180	180	180	180	180	180
	f [mm/U]	0,250	0,250	0,300	0,300	0,400	0,400	0,550
	v _f [mm/min]	2200	2050	2160	2010	2280	1920	2260
	n [1/min]	8800	8200	7200	6700	5700	4800	4100
NE-Metalle Cu-Legierungen	v _c [m/min]	200	200	200	200	200	200	200
	f [mm/U]	0,250	0,250	0,300	0,300	0,400	0,400	0,550
	v _f [mm/min]	2450	2280	2400	2250	2560	2120	2480
	n [1/min]	9800	9100	8000	7500	6400	5300	4500

Einsatzempfehlung für Tieflochbohrer: Pilotbohrung mit HAM 30-1881 oder HAM 30-1891
Recommendation for using the deep hole drills: drilling a pilot hole with HAM 30-1881 or HAM 30-1891

HAM 30-2800

Vollhartmetall-Zentrierbohrer
solid carbide center drill

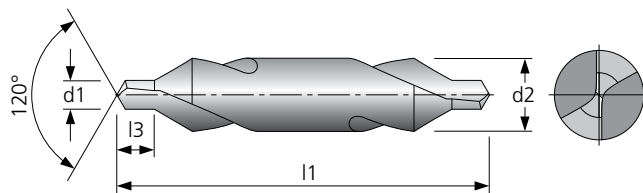
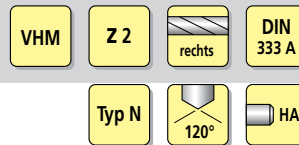

Material	Alu Knetleg.	Alu Gussleg.	Stahl < 800 N/mm²	Stahl < 1200 N/mm²	Stahl < 1600 N/mm²	Stahl < 55 HRC	Stahl < 60 HRC	Stahl < 66 HRC	INOX < 800 N/mm²	INOX > 800 N/mm²	GG	GGG	hochw. Legierungen	Titan	NE-Metalle Cu-Leg.	Graphit & Faserverbund	MMS	max.	ohne	AIR
30-2800	●	●	●	●	●				○	○	●	●	○	○	●		●	●	○	○

● sehr gut geeignet / very suitable ○ bedingt geeignet / limited suitable

HAM 30-2800

Werkstoffgruppe material group	Ø mm	0,5	0,8	1	1,25	1,6	2	2,5	3,15	4	5	6,3
Alu Knetlegierungen	V _c [m/min]	100	100	100	100	100	100	100	100	100	100	100
	f [mm/U]	0,010	0,010	0,010	0,010	0,020	0,020	0,020	0,020	0,030	0,030	0,060
	V _f [mm/min]	500	400	320	260	400	320	250	200	240	190	310
	n [1/min]	min. 50000	39800	31800	25500	19900	15900	12700	10100	8000	6400	5100
Alu Gusslegierungen	V _c [m/min]	80	80	80	80	80	80	80	80	80	80	80
	f [mm/U]	0,010	0,010	0,010	0,010	0,020	0,020	0,020	0,020	0,030	0,030	0,060
	V _f [mm/min]	500	320	260	200	320	250	200	160	190	150	240
	n [1/min]	min. 50000	31800	25500	20400	15900	12700	10200	8100	6400	5100	4000
Stahl < 800 N/mm²	V _c [m/min]	70	70	70	70	70	70	70	70	70	70	70
	f [mm/U]	0,020	0,020	0,030	0,030	0,080	0,080	0,100	0,100	0,150	0,150	0,200
	V _f [mm/min]	890	560	670	530	1110	890	890	710	840	680	700
	n [1/min]	44600	27900	22300	17800	13900	11100	8900	7100	5600	4500	3500
Stahl < 1200 N/mm²	V _c [m/min]	60	60	60	60	60	60	60	60	60	60	60
	f [mm/U]	0,010	0,010	0,020	0,020	0,070	0,070	0,080	0,080	0,100	0,100	0,150
	V _f [mm/min]	380	240	380	310	830	670	610	490	480	380	450
	n [1/min]	38200	23900	19100	15300	11900	9500	7600	6100	4800	3800	3000
Stahl < 1600 N/mm²	V _c [m/min]	50	50	50	50	50	50	50	50	50	50	50
	f [mm/U]	0,010	0,010	0,010	0,010	0,015	0,015	0,020	0,020	0,025	0,030	0,040
	V _f [mm/min]	320	200	160	130	150	120	130	100	100	100	100
	n [1/min]	31800	19900	15900	12700	9900	8000	6400	5100	4000	3200	2500
INOX < 800 N/mm²	V _c [m/min]	30	30	30	30	30	30	30	30	30	30	30
	f [mm/U]	0,010	0,010	0,010	0,010	0,025	0,025	0,030	0,030	0,040	0,050	0,070
	V _f [mm/min]	190	120	100	80	150	120	110	90	100	100	110
	n [1/min]	19100	11900	9500	7600	6000	4800	3800	3000	2400	1900	1500
INOX > 800 N/mm²	V _c [m/min]	25	25	25	25	25	25	25	25	25	25	25
	f [mm/U]	0,010	0,010	0,010	0,010	0,020	0,020	0,025	0,025	0,030	0,040	0,050
	V _f [mm/min]	160	100	80	60	100	80	80	60	60	60	70
	n [1/min]	15900	9900	8000	6400	5000	4000	3200	2500	2000	1600	1300
GG	V _c [m/min]	70	70	70	70	70	70	70	70	70	70	70
	f [mm/U]	0,010	0,010	0,030	0,030	0,060	0,060	0,080	0,080	0,100	0,100	0,150
	V _f [mm/min]	450	280	670	530	830	670	710	570	560	450	530
	n [1/min]	44600	27900	22300	17800	13900	11100	8900	7100	5600	4500	3500
GGG	V _c [m/min]	60	60	60	60	60	60	60	60	60	60	60
	f [mm/U]	0,010	0,010	0,020	0,020	0,050	0,050	0,070	0,070	0,100	0,100	0,120
	V _f [mm/min]	380	240	380	310	600	480	530	430	480	380	360
	n [1/min]	38200	23900	19100	15300	11900	9500	7600	6100	4800	3800	3000
hochwarmfeste Legierungen	V _c [m/min]	25	25	25	25	25	25	25	25	25	25	25
	f [mm/U]	0,010	0,010	0,010	0,010	0,015	0,015	0,020	0,020	0,025	0,030	0,040
	V _f [mm/min]	160	100	80	60	80	60	60	50	50	50	50
	n [1/min]	15900	9900	8000	6400	5000	4000	3200	2500	2000	1600	1300
Titan	V _c [m/min]	20	20	20	20	20	20	20	20	20	20	20
	f [mm/U]	0,010	0,010	0,010	0,010	0,015	0,015	0,020	0,020	0,025	0,030	0,035
	V _f [mm/min]	130	80	60	50	60	50	50	40	40	40	40
	n [1/min]	12700	8000	6400	5100	4000	3200	2500	2000	1600	1300	1000
NE-Metalle Cu-Legierungen	V _c [m/min]	150	150	150	150	150	150	150	150	150	150	150
	f [mm/U]	0,010	0,010	0,010	0,010	0,010	0,010	0,010	0,010	0,030	0,030	0,050
	V _f [mm/min]	500	500	480	380	300	240	190	150	360	290	380
	n [1/min]	min. 50000	min. 50000	47700	38200	29800	23900	19100	15200	11900	9500	7600

HAM 30-2840

Vollhartmetall-NC-Anbohrer
solid carbide NC-center drill

VHM Z 2 30° rechts Werk Norm
Typ N 120° HA
SHRINK FIT

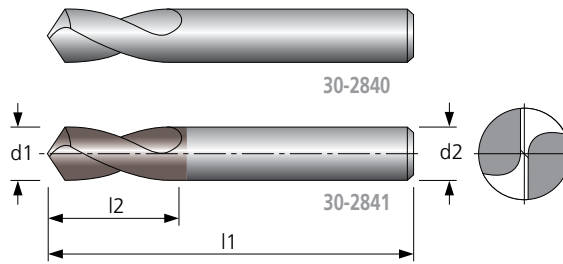

Material	Alu Knetleg.	Alu Gussleg.	Stahl < 800 N/mm²	Stahl < 1200 N/mm²	Stahl < 1600 N/mm²	Stahl < 55 HRC	Stahl < 60 HRC	Stahl < 66 HRC	INOX < 800 N/mm²	INOX > 800 N/mm²	GG	GGG	hochw. Legierungen	Titan	NE-Metalle Cu-Leg.	Graphit & Faserverbund	MMS	max.	ohne	AIR
30-2840	●	●	○	○							○				●	○	●	●	○	○
30-2841	○	○	●	●	○				○	○	●	●	○	○	○	○	●	●	○	○

● sehr gut geeignet / very suitable ○ bedingt geeignet / limited suitable

HAM 30-2840* / 30-2841		* unbeschichtete Werkzeuge HAM 30-2840: v _c x 0,9 (ca.) * uncoated tools HAM 30-2840: v _c x 0,9 (ca.)						
Werkstoffgruppe material group	Ø mm	5	6	8	10	12	16	20
Alu Knetlegierungen	v _c [m/min]	200	200	200	200	200	200	200
	f [mm/U]	0,100	0,120	0,150	0,200	0,220	0,250	0,300
	v _f [mm/min]	1270	1270	1200	1280	1170	1000	960
	n [1/min]	12700	10600	8000	6400	5300	4000	3200
Alu Gusslegierungen	v _c [m/min]	150	150	150	150	150	150	150
	f [mm/U]	0,100	0,120	0,150	0,200	0,220	0,250	0,300
	v _f [mm/min]	950	960	900	960	880	750	720
	n [1/min]	9500	8000	6000	4800	4000	3000	2400
Stahl < 800 N/mm²	v _c [m/min]	100	100	100	100	100	100	100
	f [mm/U]	0,080	0,100	0,120	0,150	0,180	0,200	0,220
	v _f [mm/min]	510	530	480	480	490	400	350
	n [1/min]	6400	5300	4000	3200	2700	2000	1600
Stahl < 1200 N/mm²	v _c [m/min]	80	80	80	80	80	80	80
	f [mm/U]	0,080	0,100	0,120	0,150	0,180	0,200	0,220
	v _f [mm/min]	410	420	380	380	380	320	290
	n [1/min]	5100	4200	3200	2500	2100	1600	1300
Stahl < 1600 N/mm²	v _c [m/min]	70	70	70	70	70	70	70
	f [mm/U]	0,060	0,080	0,100	0,120	0,150	0,180	0,200
	v _f [mm/min]	270	300	280	260	290	250	220
	n [1/min]	4500	3700	2800	2200	1900	1400	1100
INOX < 800 N/mm²	v _c [m/min]	50	50	50	50	50	50	50
	f [mm/U]	0,040	0,060	0,080	0,100	0,120	0,150	0,180
	v _f [mm/min]	130	160	160	160	160	150	140
	n [1/min]	3200	2700	2000	1600	1300	1000	800
INOX > 800 N/mm²	v _c [m/min]	30	30	30	30	30	30	30
	f [mm/U]	0,040	0,060	0,080	0,100	0,120	0,150	0,180
	v _f [mm/min]	80	100	100	100	100	90	90
	n [1/min]	1900	1600	1200	1000	800	600	500
GG	v _c [m/min]	70	70	70	70	70	70	70
	f [mm/U]	0,060	0,080	0,100	0,120	0,150	0,180	0,200
	v _f [mm/min]	270	300	280	260	290	250	220
	n [1/min]	4500	3700	2800	2200	1900	1400	1100
GGG	v _c [m/min]	60	60	60	60	60	60	60
	f [mm/U]	0,040	0,060	0,080	0,100	0,120	0,150	0,180
	v _f [mm/min]	150	190	190	190	190	180	180
	n [1/min]	3800	3200	2400	1900	1600	1200	1000
hochwarmfeste Legierungen	v _c [m/min]	30	30	30	30	30	30	30
	f [mm/U]	0,030	0,050	0,070	0,090	0,100	0,120	0,150
	v _f [mm/min]	60	80	80	90	80	70	80
	n [1/min]	1900	1600	1200	1000	800	600	500
Titan	v _c [m/min]	20	20	20	20	20	20	20
	f [mm/U]	0,020	0,040	0,060	0,080	0,100	0,120	0,150
	v _f [mm/min]	30	40	50	50	50	50	50
	n [1/min]	1300	1100	800	600	500	400	300
NE-Metalle Cu-Legierungen	v _c [m/min]	100	100	100	100	100	100	100
	f [mm/U]	0,080	0,100	0,120	0,150	0,180	0,200	0,220
	v _f [mm/min]	510	530	480	480	490	400	350
	n [1/min]	6400	5300	4000	3200	2700	2000	1600
Graphit & Faserverbund	v _c [m/min]	20	20	20	20	20	20	20
	f [mm/U]	0,020	0,040	0,060	0,080	0,100	0,120	0,150
	v _f [mm/min]	30	40	50	50	50	50	50
	n [1/min]	1300	1100	800	600	500	400	300

HAM 30-2880

Vollhartmetall-NC-Anbohrer
solid carbide NC-center drill

VHM Z 2 20° rechts Werk Norm
Typ N 90° HA
SHRINK FIT

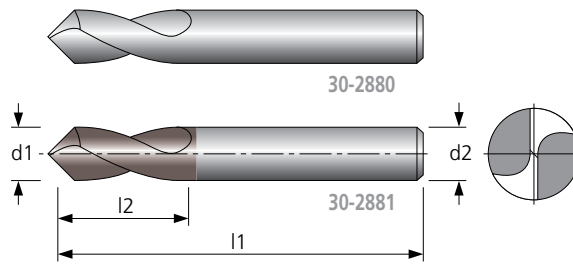

Material	Alu Knet-leg.	Alu Guss-leg.	Stahl < 800 N/mm²	Stahl < 1200 N/mm²	Stahl < 1600 N/mm²	Stahl < 55 HRC	Stahl < 60 HRC	Stahl < 66 HRC	INOX < 800 N/mm²	INOX > 800 N/mm²	GG	GGG	hochw. Legierungen	Titan	NE-Metalle Cu-Leg.	Graphit & Faserverbund	MMS	max.	ohne	AIR
30-2880	●	●	○	○							○				●	○	●	●	○	○
30-2881	○	○	●	●	○				○	○	●	●	○	○	○	○	●	●	○	○

● sehr gut geeignet / very suitable ○ bedingt geeignet / limited suitable

HAM 30-2880* / 30-2881		* unbeschichtete Werkzeuge HAM 30-2880: v _c x 0,9 (ca.) * uncoated tools HAM 30-2880: v _c x 0,9 (ca.)							
Werkstoffgruppe material group	Ø mm	5	6	8	10	12	16	20	
Alu Knetlegierungen	v _c [m/min]	200	200	200	200	200	200	200	
	f [mm/U]	0,100	0,120	0,150	0,200	0,220	0,250	0,300	
	v _f [mm/min]	1270	1270	1200	1280	1170	1000	960	
	n [1/min]	12700	10600	8000	6400	5300	4000	3200	
Alu Gusslegierungen	v _c [m/min]	150	150	150	150	150	150	150	
	f [mm/U]	0,100	0,120	0,150	0,200	0,220	0,250	0,300	
	v _f [mm/min]	950	960	900	960	880	750	720	
	n [1/min]	9500	8000	6000	4800	4000	3000	2400	
Stahl < 800 N/mm²	v _c [m/min]	100	100	100	100	100	100	100	
	f [mm/U]	0,080	0,100	0,120	0,150	0,180	0,200	0,220	
	v _f [mm/min]	510	530	480	480	490	400	350	
	n [1/min]	6400	5300	4000	3200	2700	2000	1600	
Stahl < 1200 N/mm²	v _c [m/min]	80	80	80	80	80	80	80	
	f [mm/U]	0,080	0,100	0,120	0,150	0,180	0,200	0,220	
	v _f [mm/min]	410	420	380	380	380	320	290	
	n [1/min]	5100	4200	3200	2500	2100	1600	1300	
Stahl < 1600 N/mm²	v _c [m/min]	70	70	70	70	70	70	70	
	f [mm/U]	0,060	0,080	0,100	0,120	0,150	0,180	0,200	
	v _f [mm/min]	270	300	280	260	290	250	220	
	n [1/min]	4500	3700	2800	2200	1900	1400	1100	
INOX < 800 N/mm²	v _c [m/min]	50	50	50	50	50	50	50	
	f [mm/U]	0,040	0,060	0,080	0,100	0,120	0,150	0,180	
	v _f [mm/min]	130	160	160	160	160	150	140	
	n [1/min]	3200	2700	2000	1600	1300	1000	800	
INOX > 800 N/mm²	v _c [m/min]	30	30	30	30	30	30	30	
	f [mm/U]	0,040	0,060	0,080	0,100	0,120	0,150	0,180	
	v _f [mm/min]	80	100	100	100	100	90	90	
	n [1/min]	1900	1600	1200	1000	800	600	500	
GG	v _c [m/min]	70	70	70	70	70	70	70	
	f [mm/U]	0,060	0,080	0,100	0,120	0,150	0,180	0,200	
	v _f [mm/min]	270	300	280	260	290	250	220	
	n [1/min]	4500	3700	2800	2200	1900	1400	1100	
GGG	v _c [m/min]	60	60	60	60	60	60	60	
	f [mm/U]	0,040	0,060	0,080	0,100	0,120	0,150	0,180	
	v _f [mm/min]	150	190	190	190	190	180	180	
	n [1/min]	3800	3200	2400	1900	1600	1200	1000	
hochwarmfeste Legierungen	v _c [m/min]	30	30	30	30	30	30	30	
	f [mm/U]	0,030	0,050	0,070	0,090	0,100	0,120	0,150	
	v _f [mm/min]	60	80	80	90	80	70	80	
	n [1/min]	1900	1600	1200	1000	800	600	500	
Titan	v _c [m/min]	20	20	20	20	20	20	20	
	f [mm/U]	0,020	0,040	0,060	0,080	0,100	0,120	0,150	
	v _f [mm/min]	30	40	50	50	50	50	50	
	n [1/min]	1300	1100	800	600	500	400	300	
NE-Metalle Cu-Legierungen	v _c [m/min]	100	100	100	100	100	100	100	
	f [mm/U]	0,080	0,100	0,120	0,150	0,180	0,200	0,220	
	v _f [mm/min]	510	530	480	480	490	400	350	
	n [1/min]	6400	5300	4000	3200	2700	2000	1600	
Graphit & Faserverbund	v _c [m/min]	20	20	20	20	20	20	20	
	f [mm/U]	0,020	0,040	0,060	0,080	0,100	0,120	0,150	
	v _f [mm/min]	30	40	50	50	50	50	50	
	n [1/min]	1300	1100	800	600	500	400	300	

HAM 30-2920

Vollhartmetall-Dreischneidensenker
solid carbide three fluted countersinker

VHM Z 3 0° Nut DIN 335 C
 Typ Werk 90° HA

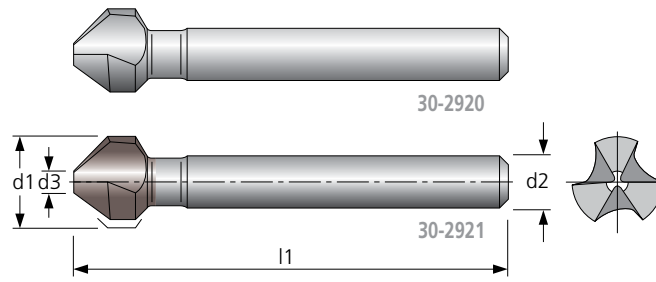

Material	Alu Knetleg.	Alu Gussleg.	Stahl < 800 N/mm²	Stahl < 1200 N/mm²	Stahl < 1600 N/mm²	Stahl < 55 HRC	Stahl < 60 HRC	Stahl < 66 HRC	INOX < 800 N/mm²	INOX > 800 N/mm²	GG	GGG	hochw. Legierungen	Titan	NE-Metalle Cu-Leg.	Graphit & Faserverbund	MMS	max.	ohne	AIR	
30-2920	●	●	○	○	○	○	○	○	○	○	○	●	○	○	○	○	○	●	●	○	○
30-2921	○	○	●	●	●	●	○	○	○	○	●	●	○	○	○	○	○	●	●	○	○

● sehr gut geeignet / very suitable ○ bedingt geeignet / limited suitable

HAM 30-2920* / 30-2921

* unbeschichtete Werkzeuge HAM 30-2920: $v_c \times 0,9$ (ca.)
 * uncoated tools HAM 30-2920: $v_c \times 0,9$ (ca.)

Werkstoffgruppe material group	Ø mm	6,3	8,3	10,4	12,4	15	16,5	20,5	25	31
Alu Knetlegierungen	v_c [m/min]	150	150	150	150	150	150	150	150	150
	f [mm/U]	0,170	0,180	0,190	0,200	0,210	0,220	0,230	0,240	0,250
	v_f [mm/min]	1290	1040	870	780	670	640	530	460	380
	n [1/min]	7600	5800	4600	3900	3200	2900	2300	1900	1500
Alu Gusslegierungen	v_c [m/min]	120	120	120	120	120	120	120	120	120
	f [mm/U]	0,150	0,160	0,180	0,190	0,200	0,210	0,220	0,230	0,240
	v_f [mm/min]	920	740	670	590	500	480	420	350	290
	n [1/min]	6100	4600	3700	3100	2500	2300	1900	1500	1200
Stahl < 800 N/mm²	v_c [m/min]	55	55	55	55	55	55	55	55	55
	f [mm/U]	0,120	0,130	0,140	0,160	0,170	0,180	0,190	0,200	0,210
	v_f [mm/min]	340	270	240	220	200	200	170	140	130
	n [1/min]	2800	2100	1700	1400	1200	1100	900	700	600
Stahl < 1200 N/mm²	v_c [m/min]	50	50	50	50	50	50	50	50	50
	f [mm/U]	0,080	0,090	0,100	0,110	0,120	0,130	0,140	0,150	0,160
	v_f [mm/min]	200	170	150	140	130	130	110	90	80
	n [1/min]	2500	1900	1500	1300	1100	1000	800	600	500
Stahl < 1600 N/mm²	v_c [m/min]	25	25	25	25	25	25	25	25	25
	f [mm/U]	0,050	0,060	0,070	0,080	0,090	0,100	0,110	0,120	0,130
	v_f [mm/min]	70	60	60	50	50	50	40	40	40
	n [1/min]	1300	1000	800	600	500	500	400	300	300
Stahl < 55 HRC	v_c [m/min]	35	35	35	35	35	35	35	35	35
	f [mm/U]	0,030	0,040	0,045	0,050	0,055	0,060	0,070	0,075	0,080
	v_f [mm/min]	50	50	50	50	40	40	40	30	30
	n [1/min]	1800	1300	1100	900	700	700	500	400	400
Stahl < 60 HRC	v_c [m/min]	25	25	25	25	25	25	25	25	25
	f [mm/U]	0,020	0,030	0,040	0,045	0,050	0,055	0,060	0,065	0,070
	v_f [mm/min]	30	30	30	30	30	30	20	20	20
	n [1/min]	1300	1000	800	600	500	500	400	300	300
INOX < 800 N/mm²	v_c [m/min]	35	35	35	35	35	35	35	35	35
	f [mm/U]	0,050	0,060	0,070	0,080	0,090	0,100	0,110	0,120	0,130
	v_f [mm/min]	90	80	80	70	60	70	60	50	50
	n [1/min]	1800	1300	1100	900	700	700	500	400	400
INOX > 800 N/mm²	v_c [m/min]	25	25	25	25	25	25	25	25	25
	f [mm/U]	0,030	0,040	0,045	0,050	0,055	0,060	0,070	0,075	0,080
	v_f [mm/min]	40	40	40	30	30	30	30	20	20
	n [1/min]	1300	1000	800	600	500	500	400	300	300
GG	v_c [m/min]	40	40	40	40	40	40	40	40	40
	f [mm/U]	0,080	0,090	0,100	0,110	0,120	0,130	0,140	0,150	0,160
	v_f [mm/min]	160	140	120	110	100	100	80	80	60
	n [1/min]	2000	1500	1200	1000	800	800	600	500	400
GGG	v_c [m/min]	35	35	35	35	35	35	35	35	35
	f [mm/U]	0,050	0,060	0,070	0,080	0,090	0,100	0,110	0,120	0,130
	v_f [mm/min]	90	80	80	70	60	70	60	50	50
	n [1/min]	1800	1300	1100	900	700	700	500	400	400

HAM 30-2920* / 30-2921		* unbeschichtete Werkzeuge HAM 30-2920: $v_c \times 0,9$ (ca.) * uncoated tools HAM 30-2920: $v_c \times 0,9$ (ca.)								
Werkstoffgruppe material group	Ø mm	6,3	8,3	10,4	12,4	15	16,5	20,5	25	31
hochwärmfeste Legierungen	v_c [m/min]	20	20	20	20	20	20	20	20	20
	f [mm/U]	0,030	0,040	0,045	0,050	0,055	0,060	0,070	0,075	0,080
	v_f [mm/min]	30	30	30	30	20	20	20	20	20
	n [1/min]	1000	800	600	500	400	400	300	300	200
Titan	v_c [m/min]	20	20	20	20	20	20	20	20	20
	f [mm/U]	0,080	0,090	0,100	0,110	0,120	0,130	0,140	0,150	0,160
	v_f [mm/min]	80	70	60	60	50	50	40	50	30
	n [1/min]	1000	800	600	500	400	400	300	300	200
NE-Metalle Cu-Legierungen	v_c [m/min]	85	85	85	85	85	85	85	85	85
	f [mm/U]	0,120	0,130	0,140	0,160	0,170	0,180	0,190	0,200	0,210
	v_f [mm/min]	520	430	360	350	310	290	250	220	190
	n [1/min]	4300	3300	2600	2200	1800	1600	1300	1100	900
Graphit & Faserverbund	v_c [m/min]	50	50	50	50	50	50	50	50	50
	f [mm/U]	0,050	0,060	0,070	0,080	0,090	0,100	0,110	0,120	0,130
	v_f [mm/min]	130	110	110	100	100	100	90	70	70
	n [1/min]	2500	1900	1500	1300	1100	1000	800	600	500

HAM 50-1040

Vollhartmetall-Maschinenreibahlen solid carbide chucking reamers

VHM	Z 4-6	6°-8° li	Werk Norm
Typ Werk	H 7	HA	

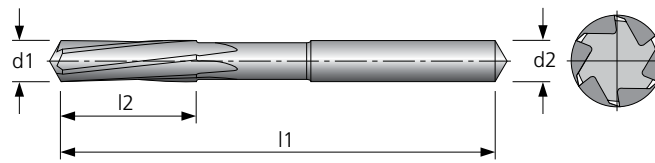

Material	Alu Knetleg.	Alu Gussleg.	Stahl < 800 N/mm²	Stahl < 1200 N/mm²	Stahl < 1600 N/mm²	Stahl < 55 HRC	Stahl < 60 HRC	Stahl < 66 HRC	INOX < 800 N/mm²	INOX > 800 N/mm²	GG	GGG	hochw. Legierungen	Titan	NE-Metalle Cu-Leg.	Graphit & Faserverbund	MMS	max.	ohne	AIR
50-1040	●	●	●	●	●	●			○	○	●	●	○	●	●		○	●		

● sehr gut geeignet / very suitable ○ bedingt geeignet / limited suitable

HAM 50-1040

Werkstoffgruppe material group	Ø mm	2	4	6	8	10	12
Alu Knetlegierungen	v _c [m/min]	40	40	40	40	40	40
	f [mm/U]	0,100	0,150	0,150	0,200	0,250	0,300
	v _f [mm/min]	640	480	320	320	330	330
	n [1/min]	6400	3200	2100	1600	1300	1100
Alu Gusslegierungen	v _c [m/min]	35	35	35	35	35	35
	f [mm/U]	0,100	0,150	0,150	0,150	0,200	0,250
	v _f [mm/min]	560	420	290	210	220	230
	n [1/min]	5600	2800	1900	1400	1100	900
Stahl < 800 N/mm²	v _c [m/min]	30	30	30	30	30	30
	f [mm/U]	0,080	0,100	0,120	0,160	0,180	0,200
	v _f [mm/min]	380	240	190	190	180	160
	n [1/min]	4800	2400	1600	1200	1000	800
Stahl < 1200 N/mm²	v _c [m/min]	25	25	25	25	25	25
	f [mm/U]	0,060	0,080	0,100	0,120	0,160	0,180
	v _f [mm/min]	240	160	130	120	130	130
	n [1/min]	4000	2000	1300	1000	800	700
Stahl < 1600 N/mm²	v _c [m/min]	20	20	20	20	20	20
	f [mm/U]	0,040	0,060	0,080	0,100	0,120	0,140
	v _f [mm/min]	130	100	90	80	70	70
	n [1/min]	3200	1600	1100	800	600	500
Stahl < 55 HRC	v _c [m/min]	10	10	10	10	10	10
	f [mm/U]	0,020	0,040	0,050	0,060	0,080	0,100
	v _f [mm/min]	30	30	30	20	20	30
	n [1/min]	1600	800	500	400	300	300
INOX < 800 N/mm²	v _c [m/min]	15	15	15	15	15	15
	f [mm/U]	0,020	0,040	0,050	0,060	0,080	0,100
	v _f [mm/min]	50	50	40	40	40	40
	n [1/min]	2400	1200	800	600	500	400
INOX > 800 N/mm²	v _c [m/min]	10	10	10	10	10	10
	f [mm/U]	0,020	0,040	0,050	0,060	0,080	0,100
	v _f [mm/min]	30	30	30	20	20	30
	n [1/min]	1600	800	500	400	300	300
GG	v _c [m/min]	30	30	30	30	30	30
	f [mm/U]	0,060	0,080	0,100	0,120	0,160	0,180
	v _f [mm/min]	290	190	160	140	160	140
	n [1/min]	4800	2400	1600	1200	1000	800
GGG	v _c [m/min]	25	25	25	25	25	25
	f [mm/U]	0,040	0,060	0,080	0,100	0,120	0,140
	v _f [mm/min]	160	120	100	100	100	100
	n [1/min]	4000	2000	1300	1000	800	700
hochwarmfeste Legierungen	v _c [m/min]	10	10	10	10	10	10
	f [mm/U]	0,020	0,040	0,050	0,060	0,080	0,100
	v _f [mm/min]	30	30	30	20	20	30
	n [1/min]	1600	800	500	400	300	300
Titan	v _c [m/min]	10	10	10	10	10	10
	f [mm/U]	0,020	0,040	0,050	0,060	0,080	0,100
	v _f [mm/min]	30	30	30	20	20	30
	n [1/min]	1600	800	500	400	300	300
NE-Metalle Cu-Legierungen	v _c [m/min]	40	40	40	40	40	40
	f [mm/U]	0,100	0,120	0,160	0,180	0,220	0,250
	v _f [mm/min]	640	380	340	290	290	280
	n [1/min]	6400	3200	2100	1600	1300	1100

HAM 50-1080

Vollhartmetall-Automaten-Reibahlen
solid carbide chucking reamers

VHM Z 6-8 6°-8°re Werk Norm
Typ Werk H7 HA

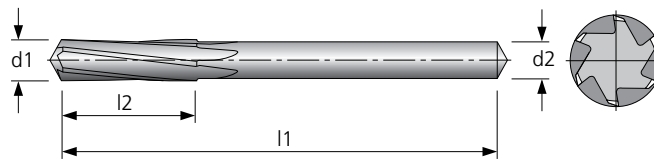

Material	Alu Knetleg.	Alu Gussleg.	Stahl < 800 N/mm²	Stahl < 1200 N/mm²	Stahl < 1600 N/mm²	Stahl < 55 HRC	Stahl < 60 HRC	Stahl < 66 HRC	INOX < 800 N/mm²	INOX > 800 N/mm²	GG	GGG	hochw. Legierungen	Titan	NE-Metalle Cu-Leg.	Graphit & Faser-verbund	MMS	max.	ohne	AIR
50-1080	●	●	●	●	●	●			○	○	●	●	○	●	●		○	●		

● sehr gut geeignet / very suitable ○ bedingt geeignet / limited suitable

HAM 50-1080

Werkstoffgruppe material group	Ø mm	3	4	6	8	10	12	14
Alu Knetlegierungen	V _c [m/min]	40	40	40	40	40	40	40
	f [mm/U]	0,100	0,150	0,150	0,200	0,250	0,300	0,350
	V _f [mm/min]	420	480	320	320	330	330	320
	n [1/min]	4200	3200	2100	1600	1300	1100	900
Alu Gusslegierungen	V _c [m/min]	35	35	35	35	35	35	35
	f [mm/U]	0,100	0,150	0,150	0,150	0,200	0,250	0,300
	V _f [mm/min]	370	420	290	210	220	230	240
	n [1/min]	3700	2800	1900	1400	1100	900	800
Stahl < 800 N/mm²	V _c [m/min]	30	30	30	30	30	30	30
	f [mm/U]	0,080	0,100	0,120	0,160	0,180	0,200	0,250
	V _f [mm/min]	260	240	190	190	180	160	180
	n [1/min]	3200	2400	1600	1200	1000	800	700
Stahl < 1200 N/mm²	V _c [m/min]	25	25	25	25	25	25	25
	f [mm/U]	0,060	0,080	0,100	0,120	0,160	0,180	0,200
	V _f [mm/min]	160	160	130	120	130	130	120
	n [1/min]	2700	2000	1300	1000	800	700	600
Stahl < 1600 N/mm²	V _c [m/min]	20	20	20	20	20	20	20
	f [mm/U]	0,040	0,060	0,080	0,100	0,120	0,140	0,160
	V _f [mm/min]	80	100	90	80	70	70	80
	n [1/min]	2100	1600	1100	800	600	500	500
Stahl < 55 HRC	V _c [m/min]	10	10	10	10	10	10	10
	f [mm/U]	0,020	0,040	0,050	0,060	0,080	0,100	0,120
	V _f [mm/min]	20	30	30	20	20	30	20
	n [1/min]	1100	800	500	400	300	300	200
INOX < 800 N/mm²	V _c [m/min]	15	15	15	15	15	15	15
	f [mm/U]	0,020	0,040	0,050	0,060	0,080	0,100	0,120
	V _f [mm/min]	30	50	40	40	40	40	40
	n [1/min]	1600	1200	800	600	500	400	300
INOX > 800 N/mm²	V _c [m/min]	10	10	10	10	10	10	10
	f [mm/U]	0,020	0,040	0,050	0,060	0,080	0,100	0,120
	V _f [mm/min]	20	30	30	20	20	30	20
	n [1/min]	1100	800	500	400	300	300	200
GG	V _c [m/min]	30	30	30	30	30	30	30
	f [mm/U]	0,060	0,080	0,100	0,120	0,160	0,180	0,200
	V _f [mm/min]	190	190	160	140	160	140	140
	n [1/min]	3200	2400	1600	1200	1000	800	700
GGG	V _c [m/min]	25	25	25	25	25	25	25
	f [mm/U]	0,040	0,060	0,080	0,100	0,120	0,140	0,160
	V _f [mm/min]	110	120	100	100	100	100	100
	n [1/min]	2700	2000	1300	1000	800	700	600
hochwarmfeste Legierungen	V _c [m/min]	10	10	10	10	10	10	10
	f [mm/U]	0,020	0,040	0,050	0,060	0,080	0,100	0,120
	V _f [mm/min]	20	30	30	20	20	30	20
	n [1/min]	1100	800	500	400	300	300	200
Titan	V _c [m/min]	10	10	10	10	10	10	10
	f [mm/U]	0,020	0,040	0,050	0,060	0,080	0,100	0,120
	V _f [mm/min]	20	30	30	20	20	30	20
	n [1/min]	1100	800	500	400	300	300	200
NE-Metalle Cu-Legierungen	V _c [m/min]	40	40	40	40	40	40	40
	f [mm/U]	0,100	0,120	0,160	0,180	0,220	0,250	0,280
	V _f [mm/min]	420	380	340	290	290	280	250
	n [1/min]	4200	3200	2100	1600	1300	1100	900

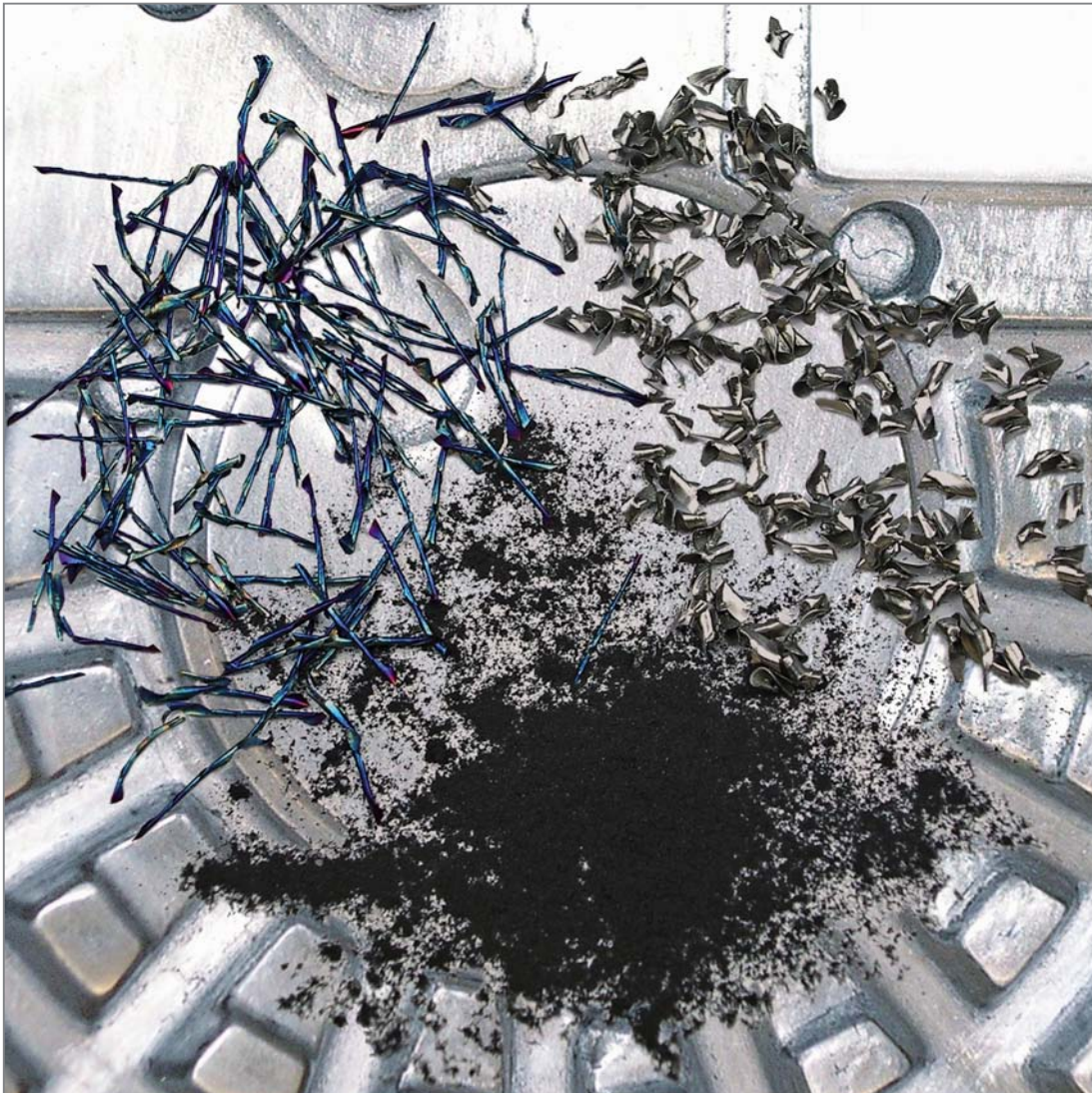

Diese Schnittdaten sind Richtwerte, die am oberen Bearbeitungslimit orientiert sind. Sie müssen auf die jeweiligen Einsatzbedingungen nach eigenen Erfahrungen angepasst werden.

These cutting data are based on our experience and determined for the upper machining limit. They have to be adjusted to particular working conditions.

Formeln für die Zerspanung / Formulas for the machining		
Drehzahl <i>revolution</i>	$n = \frac{v_c \times 1000}{\pi \times d_1}$	U/min <i>rev/min</i>
Schnittgeschwindigkeit <i>cutting speed</i>	$v_c = \frac{d_1 \times \pi \times n}{1000}$	m/min <i>m/min</i>
Vorschubgeschwindigkeit <i>feed rate</i>	$v_f = f_z \times z \times n$	mm/min <i>mm/min</i>
Vorschub pro Zahn <i>feed per tooth</i>	$f_z = \frac{v_f}{n \times z}$	mm/z <i>mm/tooth</i>
Vorschub pro Umdrehung <i>feed per revolution</i>	$f_n = \frac{v_f}{n}$	mm/U <i>mm/rev</i>
Mittenspanndicke <i>mean chip thickness</i>	$h_m = f_z \times \sqrt{\frac{a_e}{d_1}}$	mm <i>mm</i>
Zeitspanvolumen <i>machining volume</i>	$Q = \frac{a_p \times a_e \times v_f}{1000}$	cm ³ /min <i>cm³/min</i>

HAM 40-1000

Vollhartmetall-Schaftfräser
solid carbide end mill

VHM Z 1 30° rechts Werk Norm
Typ W HA
SHRINK FIT

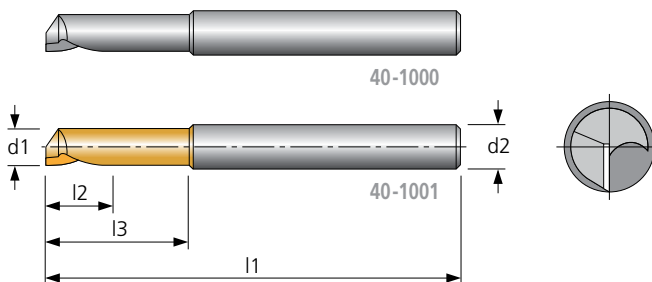

Material	Alu Knet-leg.	Alu Guss-leg.	Stahl < 800 N/mm²	Stahl < 1200 N/mm²	Stahl < 1600 N/mm²	Stahl < 55 HRC	Stahl < 60 HRC	Stahl < 66 HRC	INOX < 800 N/mm²	INOX > 800 N/mm²	GG	GGG	hochw. Legierungen	Titan	NE-Metalle Cu-Leg.	Graphit & Faser-verbund	MMS	max.	ohne	AIR
40-1000	●	○													○	○	●	●	○	○
40-1001	●	●													○	○	●	●	○	○

● sehr gut geeignet / very suitable ○ bedingt geeignet / limited suitable

HAM 40-1000 / 40-1001

Werkstoffgruppe material group	Ø mm	0,3–0,4	0,6–0,8	1–1,5	1,6–1,8	2–2,5	3
Alu Knetlegierungen	v _c [m/min]	270	360	360	360	360	360
	f _z [mm]	0,002	0,005	0,007	0,010	0,013	0,021
	v _f [mm/min]	100	250	350	500	600	800
	n [1/min]	min. 50000	min. 50000	min. 50000	min. 50000	45800	38200
Alu Gusslegierungen	v _c [m/min]	215	290	290	290	290	290
	f _z [mm]	0,002	0,004	0,006	0,009	0,011	0,018
	v _f [mm/min]	90	210	300	430	410	550
	n [1/min]	min. 50000	min. 50000	min. 50000	min. 50000	36900	30800
NE-Metalle Cu-Legierungen	v _c [m/min]	160	215	215	215	215	215
	f _z [mm]	0,002	0,005	0,007	0,010	0,013	0,021
	v _f [mm/min]	100	250	350	380	360	480
	n [1/min]	min. 50000	min. 50000	min. 50000	38000	27400	22800
Graphit & Faserverbund	v _c [m/min]	175	235	235	235	235	235
	f _z [mm]	0,003	0,007	0,009	0,013	0,017	0,027
	v _f [mm/min]	130	330	460	540	510	680
	n [1/min]	min. 50000	min. 50000	min. 50000	41600	29900	24900

Werkstoffgruppe material group	Ø mm	4	5	6	8	10
Alu Knetlegierungen	v _c [m/min]	400	400	400	400	400
	f _z [mm]	0,025	0,032	0,045	0,060	0,080
	v _f [mm/min]	800	820	950	950	1020
	n [1/min]	31800	25500	21200	15900	12700
Alu Gusslegierungen	v _c [m/min]	320	320	320	320	320
	f _z [mm]	0,021	0,027	0,038	0,051	0,068
	v _f [mm/min]	540	550	650	650	690
	n [1/min]	25500	20400	17000	12700	10200
NE-Metalle Cu-Legierungen	v _c [m/min]	240	240	240	240	240
	f _z [mm]	0,025	0,032	0,045	0,060	0,080
	v _f [mm/min]	480	490	570	570	610
	n [1/min]	19100	15300	12700	9500	7600
Graphit & Faserverbund	v _c [m/min]	260	260	260	260	260
	f _z [mm]	0,033	0,042	0,059	0,078	0,104
	v _f [mm/min]	670	690	810	800	860
	n [1/min]	20700	16600	13800	10300	8300

		Alu Knet-leg.	Alu Guss-leg.	NE-Metalle Cu-Leg.	Graphit & Faser-verbund
	a _p	0,5 x D	0,5 x D	0,5 x D	0,5 x D
	a _e	1 x D	1 x D	1 x D	1 x D
	v _c	x 1	x 1	x 1	x 1
	f _z	x 1	x 1	x 1	x 1
	a _p	1 x D	1 x D	1 x D	1 x D
	a _e	0,1 x D	0,1 x D	0,1 x D	0,1 x D
	v _c	x 1,1	x 1,1	x 1,1	x 1,1
	f _z	x 1,5	x 1,5	x 1,5	x 1,5

HAM 40-1040

Vollhartmetall-Schaftfräser
solid carbide end mill

VHM Z2 30° rechts Werk Norm
 Typ W DIN 6535 HA
 HSF SHRINK FIT

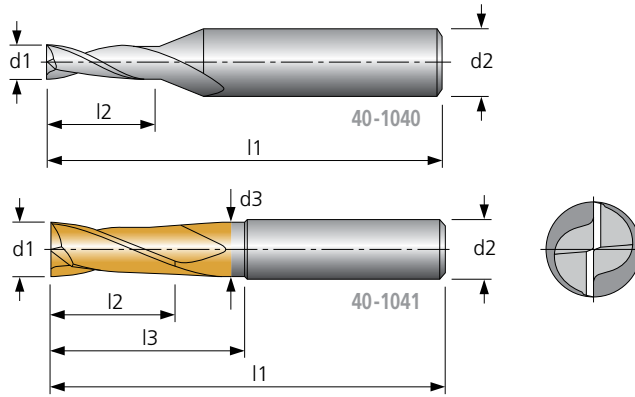

Material	Alu Knet-leg.	Alu Guss-leg.	Stahl < 800 N/mm²	Stahl < 1200 N/mm²	Stahl < 1600 N/mm²	Stahl < 55 HRC	Stahl < 60 HRC	Stahl < 66 HRC	INOX < 800 N/mm²	INOX > 800 N/mm²	GG	GGG	hochw. Legierungen	Titan	NE-Metalle Cu-Leg.	Graphit & Faser-verbund	MMS	max.	ohne	AIR
40-1040	●	○													○	○	●	●	○	○
40-1041	●	●													○	○	●	●	○	○

● sehr gut geeignet / very suitable ○ bedingt geeignet / limited suitable

HAM 40-1040* / 40-1041

* unbeschichtete Werkzeuge HAM 40-1040: $v_c \times 0,5$ (ca.)
 * uncoated tools HAM 40-1040: $v_c \times 0,5$ (ca.)

Werkstoffgruppe material group	Ø mm	1		2			3			4			5			6			8		
		l2 mm	6**	8**	5	8	12**	8	11	16**	9	13	20**	10	13	25**	12	16	30**		
Alu Knetlegierungen	v_c [m/min]	180	180	350	320	180	350	320	180	350	320	180	350	320	180	350	320	180	350	320	180
	f_z [mm]	0,007	0,012	0,027	0,025	0,020	0,033	0,030	0,024	0,036	0,033	0,027	0,042	0,038	0,032	0,060	0,054	0,045			
	v_f [mm/min]	700	690	2000	1700	760	1840	1530	690	1610	1350	620	1560	1290	610	1670	1370	650			
	n [1/min]	min.50000	28600	37100	34000	19100	27900	25500	14300	22300	20400	11500	18600	17000	9500	13900	12700	7200			
Alu Gusslegierungen	v_c [m/min]	145	145	280	255	145	280	255	145	280	255	145	280	255	145	280	255	145			
	f_z [mm]	0,006	0,010	0,023	0,021	0,017	0,028	0,026	0,020	0,031	0,028	0,023	0,036	0,032	0,027	0,051	0,046	0,038			
	v_f [mm/min]	550	470	1360	1150	520	1250	1040	470	1090	910	420	1060	870	420	1130	930	440			
	n [1/min]	46200	23100	29700	27100	15400	22300	20300	11500	17800	16200	9200	14900	13500	7700	11100	10100	5800			
NE-Metalle Cu-Legierungen	v_c [m/min]	110	110	210	190	110	210	190	110	210	190	110	210	190	110	210	190	110			
	f_z [mm]	0,007	0,012	0,027	0,025	0,020	0,033	0,030	0,024	0,036	0,033	0,027	0,042	0,038	0,032	0,060	0,054	0,045			
	v_f [mm/min]	490	420	1200	1010	470	1100	910	420	960	800	380	930	770	370	1010	820	400			
	n [1/min]	35000	17500	22300	20200	11700	16700	15100	8800	13400	12100	7000	11100	10100	5800	8400	7600	4400			
Graphit & Faserverbund	v_c [m/min]	115	115	230	210	115	230	210	115	230	210	115	230	210	115	230	210	115			
	f_z [mm]	0,009	0,016	0,035	0,033	0,026	0,043	0,039	0,031	0,047	0,043	0,035	0,055	0,049	0,042	0,078	0,070	0,059			
	v_f [mm/min]	670	570	1710	1450	630	1570	1300	570	1370	1150	510	1330	1100	510	1440	1180	540			
	n [1/min]	36600	18300	24400	22300	12200	18300	16700	9200	14600	13400	7300	12200	11100	6100	9200	8400	4600			

Werkstoffgruppe material group	Ø mm	10			12			14		16			18		20			
		l2 mm	14	22	35**	16	26	40**	18	26	22	32	50**	24	32	26	38	60**
Alu Knetlegierungen	v_c [m/min]	350	320	180	350	320	180	350	320	350	320	180	350	320	350	320	180	350
	f_z [mm]	0,080	0,072	0,058	0,090	0,082	0,065	0,110	0,100	0,120	0,110	0,090	0,145	0,130	0,200	0,180	0,140	
	v_f [mm/min]	1780	1470	660	1670	1390	620	1760	1460	1680	1410	650	1800	1480	2240	1840	810	
	n [1/min]	11100	10200	5700	9300	8500	4800	8000	7300	7000	6400	3600	6200	5700	5600	5100	2900	
Alu Gusslegierungen	v_c [m/min]	280	255	145	280	255	145	280	255	280	255	145	280	255	280	255	145	
	f_z [mm]	0,068	0,061	0,049	0,077	0,070	0,055	0,094	0,085	0,102	0,094	0,077	0,123	0,111	0,170	0,153	0,119	
	v_f [mm/min]	1210	990	450	1130	950	420	1200	990	1140	950	440	1230	990	1530	1250	550	
	n [1/min]	8900	8100	4600	7400	6800	3800	6400	5800	5600	5100	2900	5000	4500	4500	4100	2300	
NE-Metalle Cu-Legierungen	v_c [m/min]	210	190	110	210	190	110	210	190	210	190	110	210	190	210	190	110	
	f_z [mm]	0,080	0,072	0,058	0,090	0,082	0,065	0,110	0,100	0,120	0,110	0,090	0,145	0,130	0,200	0,180	0,140	
	v_f [mm/min]	1070	860	410	1010	820	380	1060	860	1010	840	400	1070	880	1320	1080	500	
	n [1/min]	6700	6000	3500	5600	5000	2900	4800	4300	4200	3800	2200	3700	3400	3300	3000	1800	
Graphit & Faserverbund	v_c [m/min]	230	210	115	230	210	115	230	210	230	210	115	230	210	230	210	115	
	f_z [mm]	0,104	0,094	0,075	0,117	0,107	0,085	0,143	0,130	0,156	0,143	0,117	0,189	0,169	0,260	0,234	0,182	
	v_f [mm/min]	1520	1250	560	1430	1190	520	1490	1250	1440	1200	540	1550	1250	1920	1540	660	
	n [1/min]	7300	6700	3700	6100	5600	3100	5200	4800	4600	4200	2300	4100	3700	3700	3300	1800	

		Alu Knet-leg.	Alu Guss-leg.	NE-Metalle Cu-Leg.	Graphit & Faser-verbund
	a_p	1 x D	1 x D	1 x D	1 x D
	a_e	1 x D	1 x D	1 x D	1 x D
	v_c	x 1	x 1	x 1	x 1
	f_z	x 1	x 1	x 1	x 1
l2**	a_p	0,3 x D	0,3 x D	0,3 x D	0,3 x D
	a_e	1 x D	1 x D	1 x D	1 x D
	v_c	x 1	x 1	x 1	x 1
	f_z	x 1	x 1	x 1	x 1

		Alu Knet-leg.	Alu Guss-leg.	NE-Metalle Cu-Leg.	Graphit & Faser-verbund
	a_p	1 x D	1 x D	1 x D	1 x D
	a_e	1 x D	1 x D	1 x D	1 x D
	v_c	x 1,1	x 1,1	x 1,1	x 1,1
	f_z	x 1,5	x 1,5	x 1,5	x 1,5

HAM 40-5380

NEU

Vollhartmetall-Schaftfräser
solid carbide end mill

VHM Z 3 45° rechts Werk Norm
 Typ W DIN 6535 HA
 HSF HSC HPC SHRINK FIT
 DIN 6535 HB

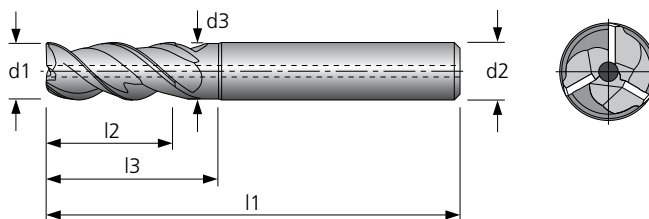

Material	Alu Knet-leg.	Alu Guss-leg.	Stahl < 800 N/mm²	Stahl < 1200 N/mm²	Stahl < 1600 N/mm²	Stahl < 55 HRC	Stahl < 60 HRC	Stahl < 66 HRC	INOX < 800 N/mm²	INOX > 800 N/mm²	GG	GGG	hochw. Legierungen	Titan	NE-Metalle Cu-Leg.	Graphit & Faser-verbund	MMS	max.	ohne	AIR
40-5380	●	●													●	○	○	○	○	●

● sehr gut geeignet / very suitable ○ bedingt geeignet / limited suitable

HAM 40-5380

Werkstoffgruppe material group	Ø mm	6	8	10	12	16	20
Alu Knetlegierungen	v _c [m/min]	600	600	600	600	600	600
	f _z [mm]	0,150	0,200	0,250	0,300	0,360	0,400
	v _f [mm/min]	14310	14340	14330	14310	12850	11400
	n [1/min]	31800	23900	19100	15900	11900	9500
Alu Gusslegierungen	v _c [m/min]	500	500	500	500	500	500
	f _z [mm]	0,150	0,200	0,250	0,300	0,360	0,400
	v _f [mm/min]	11930	11940	11930	11970	10690	9600
	n [1/min]	26500	19900	15900	13300	9900	8000
NE-Metalle Cu-Legierungen	v _c [m/min]	400	400	400	400	400	400
	f _z [mm]	0,120	0,160	0,200	0,240	0,300	0,320
	v _f [mm/min]	7630	7630	7620	7630	7200	6140
	n [1/min]	21200	15900	12700	10600	8000	6400

		Alu Knet-leg.	Alu Guss-leg.	NE-Metalle Cu-Leg.
	a _p	1,5 x D	1,5 x D	1,5 x D
	a _e	0,5 x D	0,5 x D	0,2 x D
	v _c	x 1	x 1	x 1
	f _z	x 1	x 1	x 1
	a _p	1 x D	1 x D	1 x D
	a _e	1 x D	1 x D	1 x D
	v _c	x 0,8	x 0,8	x 0,8
	f _z	x 0,6	x 0,6	x 0,6
	a _p	1,5 x D	1,5 x D	1,5 x D
	a _e	1 x D	1 x D	1 x D
	v _c	x 0,8	x 0,8	x 0,8
	f _z	x 0,5	x 0,5	x 0,5

HAM 40-5390

Vollhartmetall-Schaftfräser
solid carbide end mill

VHM Z3 45° rechts Werk Norm
 Typ W
 HSF HSC HPC SHRINK FIT
 DIN 6535 HA
 DIN 6535 HB

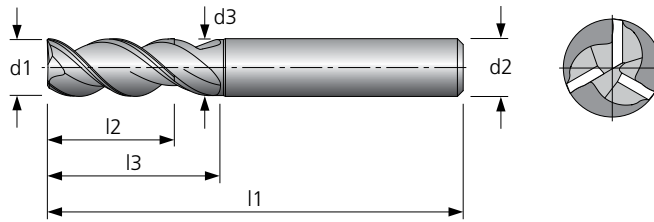

Material	Alu Knet-leg.	Alu Guss-leg.	Stahl < 800 N/mm²	Stahl < 1200 N/mm²	Stahl < 1600 N/mm²	Stahl < 55 HRC	Stahl < 60 HRC	Stahl < 66 HRC	INOX < 800 N/mm²	INOX > 800 N/mm²	GG	GGG	hochw. Legierungen	Titan	NE-Metalle Cu-Leg.	Graphit & Faser-verbund	MMS	max.	ohne	AIR
40-5390	●	●													●		○	○	○	○

● sehr gut geeignet / very suitable ○ bedingt geeignet / limited suitable

HAM 40-5390

Werkstoffgruppe material group	Ø mm	3	4	5	6	8	10	12	16	20
Alu Knetlegierungen	v _c [m/min]	400	450	500	600	600	600	600	600	600
	f _z [mm]	0,075	0,100	0,120	0,150	0,200	0,250	0,300	0,360	0,400
	v _f [mm/min]	9540	10740	11450	14310	14340	14330	14310	12850	11400
	n [1/min]	42400	35800	31800	31800	31800	23900	19100	15900	11900
Alu Gusslegierungen	v _c [m/min]	350	400	450	500	500	500	500	500	500
	f _z [mm]	0,075	0,100	0,120	0,150	0,200	0,250	0,300	0,360	0,400
	v _f [mm/min]	8350	9540	10300	11930	11940	11930	11970	10690	9600
	n [1/min]	37100	31800	28600	26500	19900	15900	13300	9900	8000
NE-Metalle Cu-Legierungen	v _c [m/min]	300	350	400	400	400	400	400	400	400
	f _z [mm]	0,060	0,080	0,095	0,120	0,160	0,200	0,240	0,300	0,320
	v _f [mm/min]	5720	6700	7270	7630	7630	7620	7630	7200	6140
	n [1/min]	31800	27900	25500	21200	15900	12700	10600	8000	6400

		Alu Knet-leg.	Alu Guss-leg.	NE-Metalle Cu-Leg.	l3 = lang/long
	a _p	1,5 x D	1,5 x D	1,5 x D	1,5 x D
	a _e	0,5 x D	0,5 x D	0,2 x D	0,2 x D
	v _c	x 1	x 1	x 1	x 0,75
	f _z	x 1	x 1	x 1	x 0,85
	a _p	1 x D	1 x D	1 x D	1 x D
	a _e	1 x D	1 x D	1 x D	1 x D
	v _c	x 0,8	x 0,8	x 0,8	x 0,65
	f _z	x 0,5	x 0,5	x 0,5	x 0,4

HAM 40-5490

Vollhartmetall-Schaftfräser
solid carbide end mill

VHM Z 3 45° rechts Werk Norm
 Typ W DIN 6535 HA
 HSF HSC HPC SHRINK FIT
 Eckradius DIN 6535 HB

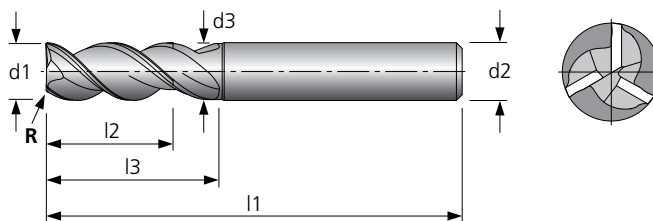

Material	Alu Knet-leg.	Alu Guss-leg.	Stahl < 800 N/mm²	Stahl < 1200 N/mm²	Stahl < 1600 N/mm²	Stahl < 55 HRC	Stahl < 60 HRC	Stahl < 66 HRC	INOX < 800 N/mm²	INOX > 800 N/mm²	GG	GGG	hochw. Legierungen	Titan	NE-Metalle Cu-Leg.	Graphit & Faser-verbund	MMS	max.	ohne	AIR
40-5490	●	●													●		○	○	○	○

● sehr gut geeignet / very suitable ○ bedingt geeignet / limited suitable

HAM 40-5490

Werkstoffgruppe material group	Ø mm	3	4	5	6	8	10	12	16	20
Alu Knetlegierungen	v _c [m/min]	400	450	500	600	600	600	600	600	600
	f _z [mm]	0,070	0,090	0,110	0,140	0,180	0,230	0,270	0,320	0,360
	v _f [mm/min]	8900	9670	10490	13360	12910	13180	12880	11420	10260
	n [1/min]	42400	35800	31800	31800	31800	23900	19100	15900	11900
Alu Gusslegierungen	v _c [m/min]	350	400	450	500	500	500	500	500	500
	f _z [mm]	0,070	0,090	0,110	0,140	0,180	0,230	0,270	0,320	0,360
	v _f [mm/min]	7790	8590	9440	11130	10750	10970	10770	9500	8640
	n [1/min]	37100	31800	28600	26500	19900	15900	13300	9900	8000
NE-Metalle Cu-Legierungen	v _c [m/min]	300	350	400	400	400	400	400	400	400
	f _z [mm]	0,050	0,070	0,090	0,110	0,140	0,180	0,220	0,270	0,290
	v _f [mm/min]	4770	5860	6890	7000	6680	6860	7000	6480	5570
	n [1/min]	31800	27900	25500	21200	15900	12700	10600	8000	6400

		Alu Knet-leg.	Alu Guss-leg.	NE-Metalle Cu-Leg.	l3 = lang/long
	a _p	1,5 x D	1,5 x D	1,5 x D	1,5 x D
	a _e	0,5 x D	0,5 x D	0,2 x D	0,2 x D
	v _c	x 1	x 1	x 1	x 0,75
	f _z	x 1	x 1	x 1	x 0,85
	a _p	1 x D	1 x D	1 x D	1 x D
	a _e	1 x D	1 x D	1 x D	1 x D
	v _c	x 0,8	x 0,8	x 0,8	x 0,65
	f _z	x 0,5	x 0,5	x 0,5	x 0,4

HAM 40-1080

Vollhartmetall-Schaftfräser
solid carbide end mill

VHM Z 2 45° rechts DIN 6527
Typ W HA
SHRINK FIT

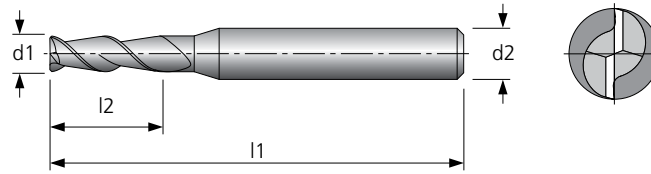

Material	Alu Knet-leg.	Alu Guss-leg.	Stahl < 800 N/mm²	Stahl < 1200 N/mm²	Stahl < 1600 N/mm²	Stahl < 55 HRC	Stahl < 60 HRC	Stahl < 66 HRC	INOX < 800 N/mm²	INOX > 800 N/mm²	GG	GGG	hochw. Legierungen	Titan	NE-Metalle Cu-Leg.	Graphit & Faser-verbund	MMS	max.	ohne	AIR
40-1080	●	●							○	○					●	○	●	●	○	○

● sehr gut geeignet / very suitable ○ bedingt geeignet / limited suitable

HAM 40-1080

Werkstoffgruppe material group	Ø mm	0,3	0,4–1	1,2–3
Alu Knetlegierungen	v _c [m/min]	330	330	330
	f _z [mm]	0,009	0,015	0,020
	v _f [mm/min]	900	1500	2000
	n [1/min]	min. 50000	min. 50000	min. 50000
Alu Gusslegierungen	v _c [m/min]	265	265	265
	f _z [mm]	0,008	0,013	0,017
	v _f [mm/min]	800	1300	1430
	n [1/min]	min. 50000	min. 50000	42200
INOX < 800 N/mm²	v _c [m/min]	70	70	70
	f _z [mm]	0,005	0,008	0,010
	v _f [mm/min]	500	510	220
	n [1/min]	min. 50000	31800	11100
INOX > 800 N/mm²	v _c [m/min]	50	50	50
	f _z [mm]	0,003	0,005	0,007
	v _f [mm/min]	300	230	110
	n [1/min]	min. 50000	22700	8000
NE-Metalle Cu-Legierungen	v _c [m/min]	200	200	200
	f _z [mm]	0,009	0,015	0,020
	v _f [mm/min]	900	1500	1270
	n [1/min]	min. 50000	min. 50000	31800
Graphit & Faserverbund	v _c [m/min]	170	170	170
	f _z [mm]	0,008	0,012	0,016
	v _f [mm/min]	800	1200	870
	n [1/min]	min. 50000	min. 50000	27100

	Alu Knet-leg.	Alu Guss-leg.	INOX < 800 N/mm²	INOX > 800 N/mm²	NE-Metalle Cu-Leg.	Graphit & Faserverbund
ap	0,5 x D	0,5 x D	0,3 x D	0,3 x D	0,5 x D	0,5 x D
ae	1 x D	1 x D	1 x D	1 x D	1 x D	1 x D
ap	1,5 x D	1,5 x D	1,5 x D	1,5 x D	1,5 x D	1,5 x D
ae	0,1 x D	0,1 x D	0,1 x D	0,1 x D	0,1 x D	0,1 x D
v _c	x 1,1	x 1,1	x 1,1	x 1,1	x 1,1	x 1,1
f _z	x 1,3	x 1,3	x 1,3	x 1,3	x 1,3	x 1,3

HAM 40-1160

**Vollhartmetall-Schaftfräser
solid carbide end mill**

VHM Z2 30° rechts Werk Norm
Typ N HA SHRINK FIT

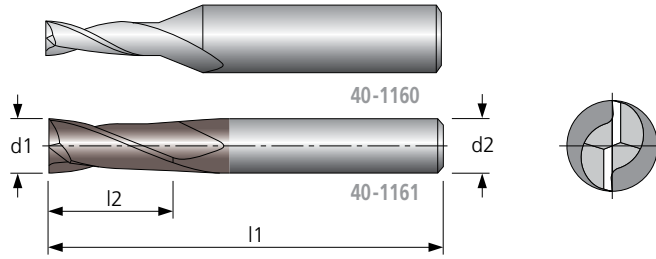

Material	Alu Knet-leg.	Alu Guss-leg.	Stahl < 800 N/mm²	Stahl < 1200 N/mm²	Stahl < 1600 N/mm²	Stahl < 55 HRC	Stahl < 60 HRC	Stahl < 66 HRC	INOX < 800 N/mm²	INOX > 800 N/mm²	GG	GGG	hochw. Legierungen	Titan	NE-Metalle Cu-Leg.	Graphit & Faser-verbund	MMS	max.	ohne	AIR
40-1160	○	○	●	○	○				○	○	●	○	○	○	○	○	●	●	○	○
40-1161	○	○	●	●	○				○	○	●	●	○	○	○	○	●	●	○	○

● sehr gut geeignet / very suitable ○ bedingt geeignet / limited suitable

HAM 40-1160* / 40-1161

* unbeschichtete Werkzeuge HAM 40-1160: $v_c \times 0,5$ (ca.)
* uncoated tools HAM 40-1160: $v_c \times 0,5$ (ca.)

Werkstoffgruppe material group	Ø mm	0,3	0,4 – 1	1,2 – 3	4	6	8	10	12	14	16	18	20
Alu Knetlegierungen	v_c [m/min]	330	330	330	330	330	330	330	330	330	330	330	330
	f_z [mm]	0,009	0,015	0,020	0,026	0,033	0,045	0,054	0,068	0,083	0,098	0,113	0,135
	v_f [mm/min]	900	1500	1950	1340	1160	1180	1130	1190	1240	1290	1310	1430
	n [1/min]	min. 50000	min. 50000	min. 50000	26300	17500	13100	10500	8800	7500	6600	5800	5300
Alu Gusslegierungen	v_c [m/min]	265	265	265	265	265	265	265	265	265	265	265	265
	f_z [mm]	0,008	0,013	0,017	0,022	0,028	0,038	0,046	0,057	0,070	0,083	0,096	0,115
	v_f [mm/min]	770	1280	1400	910	790	800	770	800	840	880	900	960
	n [1/min]	min. 50000	min. 50000	42200	21100	14100	10500	8400	7000	6000	5300	4700	4200
Stahl < 800 N/mm²	v_c [m/min]	130	130	130	130	130	130	130	130	130	130	130	130
	f_z [mm]	0,007	0,011	0,014	0,019	0,024	0,033	0,040	0,050	0,061	0,072	0,083	0,099
	v_f [mm/min]	660	1100	590	390	330	340	320	340	360	370	380	420
	n [1/min]	min. 50000	min. 50000	20700	10300	6900	5200	4100	3400	3000	2600	2300	2100
Stahl < 1200 N/mm²	v_c [m/min]	110	110	110	110	110	110	110	110	110	110	110	110
	f_z [mm]	0,006	0,010	0,013	0,017	0,022	0,030	0,036	0,045	0,055	0,065	0,075	0,090
	v_f [mm/min]	600	1000	460	300	260	260	250	260	280	290	290	320
	n [1/min]	min. 50000	min. 50000	17500	8800	5800	4400	3500	2900	2500	2200	1900	1800
Stahl < 1600 N/mm²	v_c [m/min]	95	95	95	95	95	95	95	95	95	95	95	95
	f_z [mm]	0,005	0,009	0,011	0,014	0,019	0,026	0,031	0,038	0,047	0,055	0,064	0,077
	v_f [mm/min]	510	850	330	220	190	190	180	190	210	210	220	230
	n [1/min]	min. 50000	min. 50000	15100	7600	5000	3800	3000	2500	2200	1900	1700	1500
INOX < 800 N/mm²	v_c [m/min]	70	70	70	70	70	70	70	70	70	70	70	70
	f_z [mm]	0,005	0,008	0,010	0,014	0,018	0,024	0,029	0,036	0,044	0,052	0,060	0,072
	v_f [mm/min]	480	590	230	150	130	130	130	140	140	150	140	160
	n [1/min]	min. 50000	37100	11100	5600	3700	2800	2200	1900	1600	1400	1200	1100
INOX > 800 N/mm²	v_c [m/min]	50	50	50	50	50	50	50	50	50	50	50	50
	f_z [mm]	0,003	0,005	0,007	0,009	0,012	0,016	0,019	0,024	0,029	0,035	0,040	0,048
	v_f [mm/min]	320	280	110	70	60	60	60	60	60	70	70	80
	n [1/min]	min. 50000	26500	8000	4000	2700	2000	1600	1300	1100	1000	900	800
GG	v_c [m/min]	130	130	130	130	130	130	130	130	130	130	130	130
	f_z [mm]	0,007	0,011	0,014	0,019	0,024	0,033	0,040	0,050	0,061	0,072	0,083	0,099
	v_f [mm/min]	660	1100	590	390	330	340	320	340	360	370	380	420
	n [1/min]	min. 50000	min. 50000	20700	10300	6900	5200	4100	3400	3000	2600	2300	2100
GGG	v_c [m/min]	110	110	110	110	110	110	110	110	110	110	110	110
	f_z [mm]	0,006	0,010	0,013	0,017	0,022	0,030	0,036	0,045	0,055	0,065	0,075	0,090
	v_f [mm/min]	600	1000	460	300	260	260	250	260	280	290	290	320
	n [1/min]	min. 50000	min. 50000	17500	8800	5800	4400	3500	2900	2500	2200	1900	1800
hochwärmfeste Legierungen	v_c [m/min]	35	35	35	35	35	35	35	35	35	35	35	35
	f_z [mm]	0,004	0,007	0,008	0,011	0,014	0,020	0,023	0,029	0,036	0,042	0,049	0,059
	v_f [mm/min]	290	240	90	60	50	50	50	50	60	60	60	70
	n [1/min]	37100	18600	5600	2800	1900	1400	1100	900	800	700	600	600
Titan	v_c [m/min]	60	60	60	60	60	60	60	60	60	60	60	60
	f_z [mm]	0,004	0,007	0,009	0,011	0,015	0,020	0,024	0,030	0,037	0,044	0,050	0,060
	v_f [mm/min]	400	430	170	110	90	100	90	100	100	100	110	120
	n [1/min]	min. 50000	31800	9500	4800	3200	2400	1900	1600	1400	1200	1100	1000
NE-Metalle Cu-Legierungen	v_c [m/min]	200	200	200	200	200	200	200	200	200	200	200	200
	f_z [mm]	0,009	0,015	0,020	0,026	0,033	0,045	0,054	0,068	0,083	0,098	0,113	0,135
	v_f [mm/min]	900	1500	1240	810	700	720	690	720	740	780	790	860
	n [1/min]	min. 50000	min. 50000	31800	15900	10600	8000	6400	5300	4500	4000	3500	3200

		Alu Knet-leg.	Alu Guss-leg.	Stahl < 800 N/mm²	Stahl < 1200 N/mm²	Stahl < 1600 N/mm²	INOX < 800 N/mm²	INOX > 800 N/mm²	GG	GGG	hochw. Legierungen	Titan	NE-Metalle Cu-Leg.
	a_p	0,5 x D	0,5 x D	0,3 x D	0,3 x D	0,3 x D	0,3 x D	0,3 x D	0,3 x D	0,3 x D	0,2 x D	0,2 x D	0,5 x D
	a_e	1 x D	1 x D	1 x D	1 x D	1 x D	1 x D	1 x D	1 x D	1 x D	1 x D	1 x D	1 x D
	a_p	1,5 x D	1,5 x D	1,5 x D	1,5 x D	1,5 x D	1,5 x D	1,5 x D	1,5 x D	1,5 x D	1,5 x D	1,5 x D	1,5 x D
	a_e	0,1 x D	0,1 x D	0,1 x D	0,1 x D	0,1 x D	0,1 x D	0,1 x D	0,1 x D	0,1 x D	0,05 x D	0,1 x D	0,1 x D
	v_c	x 1,1	x 1,1	x 1,1	x 1,1	x 1,1	x 1,1	x 1,1	x 1,1	x 1,1	x 1,1	x 1,1	x 1,1
	f_z	x 1,3	x 1,3	x 1,3	x 1,3	x 1,3	x 1,3	x 1,3	x 1,3	x 1,3	x 1,3	x 1,3	x 1,3

HAM 40-1201

Vollhartmetall-Schaftfräser
solid carbide end mill

VHM Z 2 30° rechts DIN 6527
Typ N DIN 6535 HA
SHRINK FIT
DIN 6535 HB

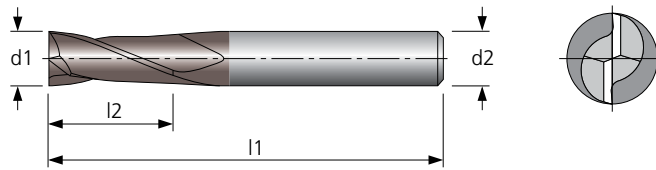

Material	Alu Knet-leg.	Alu Guss-leg.	Stahl < 800 N/mm²	Stahl < 1200 N/mm²	Stahl < 1600 N/mm²	Stahl < 55 HRC	Stahl < 60 HRC	Stahl < 66 HRC	INOX < 800 N/mm²	INOX > 800 N/mm²	GG	GGG	hochw. Legierungen	Titan	NE-Metalle Cu-Leg.	Graphit & Faser-verbund	MMS	max.	ohne	AIR	
40-1201		○	●	●	○				○	○	●	●	○	○	○	○		●	●	○	○

● sehr gut geeignet / very suitable ○ bedingt geeignet / limited suitable

HAM 40-1201

Werkstoffgruppe material group	Ø mm	2	3	4	5	6	8	10	12
Alu Gusslegierungen	V _c [m/min]	265	265	265	265	265	265	265	265
	f _z [mm]	0,008	0,013	0,017	0,022	0,028	0,038	0,046	0,059
	V _f [mm/min]	650	720	700	730	790	800	770	820
	n [1/min]	42200	28100	21100	16900	14100	10500	8400	7000
Stahl < 800 N/mm²	V _c [m/min]	130	130	130	130	130	130	130	130
	f _z [mm]	0,007	0,011	0,014	0,019	0,024	0,033	0,040	0,051
	V _f [mm/min]	270	300	290	310	330	340	320	340
Stahl < 1200 N/mm²	V _c [m/min]	110	110	110	110	110	110	110	110
	f _z [mm]	0,006	0,010	0,013	0,017	0,022	0,030	0,036	0,046
	V _f [mm/min]	210	230	230	240	260	260	250	270
Stahl < 1600 N/mm²	V _c [m/min]	95	95	95	95	95	95	95	95
	f _z [mm]	0,005	0,009	0,011	0,014	0,019	0,026	0,031	0,039
	V _f [mm/min]	150	170	170	170	190	190	180	200
INOX < 800 N/mm²	V _c [m/min]	70	70	70	70	70	70	70	70
	f _z [mm]	0,005	0,008	0,010	0,014	0,018	0,024	0,029	0,037
	V _f [mm/min]	110	120	120	120	130	130	130	140
INOX > 800 N/mm²	V _c [m/min]	50	50	50	50	50	50	50	50
	f _z [mm]	0,004	0,007	0,009	0,011	0,015	0,020	0,024	0,031
	V _f [mm/min]	60	70	70	70	80	80	80	80
GG	V _c [m/min]	130	130	130	130	130	130	130	130
	f _z [mm]	0,007	0,011	0,014	0,019	0,024	0,033	0,040	0,051
	V _f [mm/min]	270	300	290	310	330	340	320	340
GGG	V _c [m/min]	110	110	110	110	110	110	110	110
	f _z [mm]	0,006	0,010	0,013	0,017	0,022	0,030	0,036	0,046
	V _f [mm/min]	210	230	230	240	260	260	250	270
hochwarmfeste Legierungen	V _c [m/min]	35	35	35	35	35	35	35	35
	f _z [mm]	0,004	0,007	0,008	0,011	0,014	0,020	0,023	0,030
	V _f [mm/min]	40	50	50	50	50	50	50	50
Titan	V _c [m/min]	60	60	60	60	60	60	60	60
	f _z [mm]	0,004	0,007	0,009	0,011	0,015	0,020	0,024	0,031
	V _f [mm/min]	80	90	80	90	90	100	90	100
NE-Metalle Cu-Legierungen	V _c [m/min]	200	200	200	200	200	200	200	200
	f _z [mm]	0,009	0,015	0,020	0,026	0,033	0,045	0,054	0,069
	V _f [mm/min]	570	640	620	650	700	720	690	730
n [1/min]	31800	21200	15900	12700	10600	8000	6400	5300	

		Alu Guss-leg.	Stahl < 800 N/mm²	Stahl < 1200 N/mm²	Stahl < 1600 N/mm²	INOX < 800 N/mm²	INOX > 800 N/mm²	GG	GGG	hochw. Legierungen	Titan	NE-Metalle Cu-Leg.
	a _p	0,5 x D	0,3 x D	0,3 x D	0,3 x D	0,2 x D	0,3 x D	0,3 x D	0,3 x D	0,2 x D	0,2 x D	0,5 x D
	a _e	1 x D	1 x D	1 x D	1 x D	1 x D	1 x D	1 x D	1 x D	1 x D	1 x D	1 x D
	a _p	1,5 x D	1,5 x D	1,5 x D	1,5 x D	1,5 x D	1,5 x D	1,5 x D	1,5 x D	1,5 x D	1,5 x D	1,5 x D
	a _e	0,1 x D	0,1 x D	0,1 x D	0,1 x D	0,1 x D	0,1 x D	0,1 x D	0,1 x D	0,05 x D	0,1 x D	0,1 x D
	v _c	x 1,1	x 1,1	x 1,1	x 1,1	x 1,1	x 1,1	x 1,1	x 1,1	x 1,1	x 1,1	x 1,1
	f _z	x 1,3	x 1,3	x 1,3	x 1,3	x 1,3	x 1,3	x 1,3	x 1,3	x 1,3	x 1,3	x 1,3

HAM 40-1280

Vollhartmetall-Schaftfräser
solid carbide end mill

VHM Z3 30° rechts Werk Norm
Typ N HA
SHRINK FIT
HB

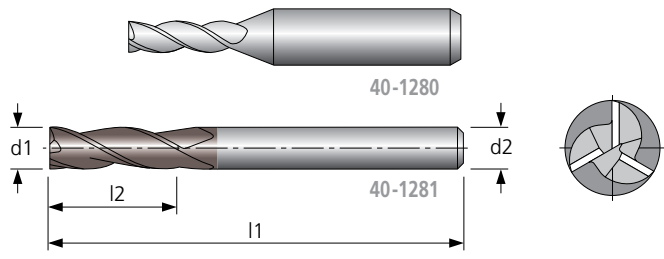

Material	Alu Knetleg.	Alu Gussleg.	Stahl < 800 N/mm²	Stahl < 1200 N/mm²	Stahl < 1600 N/mm²	Stahl < 55 HRC	Stahl < 60 HRC	Stahl < 66 HRC	INOX < 800 N/mm²	INOX > 800 N/mm²	GG	GGG	hochw. Legierungen	Titan	NE-Metalle Cu-Leg.	Graphit & Faserverbund	MMS	max.	ohne	AIR
40-1280	○	○	●	○	○	○			○	○	●	○	○	○	○		●	●	○	○
40-1281	○	○	●	●	●	○			○	○	●	●	○	○	○		●	●	○	○

● sehr gut geeignet / very suitable ○ bedingt geeignet / limited suitable

HAM 40-1280* / 40-1281

* unbeschichtete Werkzeuge HAM 40-1280: $v_c \times 0,5$ (ca.)
* uncoated tools HAM 40-1280: $v_c \times 0,5$ (ca.)

Werkstoffgruppe material group	Ø mm	< 2	2	3	4	6	8	10	12	14	16	18	20
Alu Knetlegierungen	v_c [m/min]	270	270	270	270	270	270	270	270	270	270	270	270
	f_z [mm]	0,008	0,009	0,012	0,015	0,020	0,027	0,036	0,050	0,059	0,075	0,090	0,110
	v_f [mm/min]	1130	1160	1030	970	840	870	930	1070	1070	1220	1300	1410
	n [1/min]	min. 50000	43000	28600	21500	14300	10700	8600	7200	6100	5400	4800	4300
Alu Gusslegierungen	v_c [m/min]	215	215	215	215	215	215	215	215	215	215	215	215
	f_z [mm]	0,006	0,008	0,010	0,013	0,017	0,023	0,031	0,042	0,050	0,064	0,077	0,093
	v_f [mm/min]	960	780	700	650	570	590	620	720	730	820	870	950
	n [1/min]	min. 50000	34200	22800	17100	11400	8600	6800	5700	4900	4300	3800	3400
Stahl < 800 N/mm²	v_c [m/min]	130	130	130	130	130	130	130	130	130	130	130	130
	f_z [mm]	0,006	0,007	0,009	0,011	0,014	0,020	0,026	0,036	0,043	0,055	0,066	0,080
	v_f [mm/min]	570	410	360	340	300	310	320	370	390	430	460	510
	n [1/min]	34500	20700	13800	10300	6900	5200	4100	3400	3000	2600	2300	2100
Stahl < 1200 N/mm²	v_c [m/min]	110	110	110	110	110	110	110	110	110	110	110	110
	f_z [mm]	0,005	0,006	0,008	0,010	0,013	0,018	0,024	0,033	0,039	0,050	0,060	0,073
	v_f [mm/min]	440	320	280	260	230	240	250	290	290	330	340	390
	n [1/min]	29200	17500	11700	8800	5800	4400	3500	2900	2500	2200	1900	1800
Stahl < 1600 N/mm²	v_c [m/min]	95	95	95	95	95	95	95	95	95	95	95	95
	f_z [mm]	0,004	0,005	0,007	0,009	0,011	0,015	0,020	0,028	0,033	0,043	0,051	0,062
	v_f [mm/min]	320	230	210	190	170	170	180	210	220	240	260	280
	n [1/min]	25200	15100	10100	7600	5000	3800	3000	2500	2200	1900	1700	1500
Stahl < 55 HRC	v_c [m/min]	65	65	65	65	65	65	65	65	65	65	65	65
	f_z [mm]	0,003	0,004	0,005	0,007	0,009	0,012	0,016	0,022	0,026	0,034	0,040	0,049
	v_f [mm/min]	170	150	110	100	90	90	100	110	120	130	130	150
	n [1/min]	17200	12700	6900	5200	3400	2600	2100	1700	1500	1300	1100	1000
INOX < 800 N/mm²	v_c [m/min]	70	70	70	70	70	70	70	70	70	70	70	70
	f_z [mm]	0,004	0,005	0,006	0,008	0,010	0,014	0,019	0,026	0,031	0,040	0,048	0,058
	v_f [mm/min]	220	160	140	130	120	120	130	150	150	170	170	190
	n [1/min]	18600	11150	7400	5600	3700	2800	2200	1900	1600	1400	1200	1100
INOX > 800 N/mm²	v_c [m/min]	50	50	50	50	50	50	50	50	50	50	50	50
	f_z [mm]	0,003	0,004	0,005	0,007	0,009	0,012	0,016	0,022	0,026	0,034	0,040	0,049
	v_f [mm/min]	130	100	90	80	70	70	80	90	90	100	110	120
	n [1/min]	13300	7950	5300	4000	2700	2000	1600	1300	1100	1000	900	800
GG	v_c [m/min]	130	130	130	130	130	130	130	130	130	130	130	130
	f_z [mm]	0,006	0,007	0,009	0,011	0,014	0,020	0,026	0,036	0,043	0,055	0,066	0,080
	v_f [mm/min]	570	410	360	340	300	310	320	370	390	430	460	510
	n [1/min]	34500	20700	13800	10300	6900	5200	4100	3400	3000	2600	2300	2100
GGG	v_c [m/min]	110	110	110	110	110	110	110	110	110	110	110	110
	f_z [mm]	0,005	0,006	0,008	0,010	0,013	0,018	0,024	0,033	0,039	0,050	0,060	0,073
	v_f [mm/min]	440	320	280	260	230	240	250	290	290	330	340	390
	n [1/min]	29200	17500	11700	8800	5800	4400	3500	2900	2500	2200	1900	1800
hochwärmefeste Legierungen	v_c [m/min]	35	35	35	35	35	35	35	35	35	35	35	35
	f_z [mm]	0,003	0,004	0,005	0,007	0,008	0,012	0,016	0,021	0,025	0,033	0,039	0,047
	v_f [mm/min]	90	60	60	50	50	50	50	60	60	70	70	90
	n [1/min]	9300	5550	3700	2800	1900	1400	1100	900	800	700	600	600
Titan	v_c [m/min]	60	60	60	60	60	60	60	60	60	60	60	60
	f_z [mm]	0,003	0,004	0,005	0,007	0,009	0,012	0,016	0,022	0,026	0,034	0,040	0,049
	v_f [mm/min]	160	120	100	100	80	90	90	110	110	120	130	150
	n [1/min]	15900	9550	6400	4800	3200	2400	1900	1600	1400	1200	1100	1000
NE-Metalle Cu-Legierungen	v_c [m/min]	160	160	160	160	160	160	160	160	160	160	160	160
	f_z [mm]	0,008	0,009	0,012	0,015	0,020	0,027	0,036	0,050	0,059	0,075	0,090	0,110
	v_f [mm/min]	950	690	610	570	500	520	550	620	630	720	760	820
	n [1/min]	42400	25500	17000	12700	8500	6400	5100	4200	3600	3200	2800	2500

	a_p	1 x D
	a_e	1 x D
	v_c	x 1
	f_z	x 1

	a_p	1,5 x D
	a_e	0,1 x D
	v_c	x 1,1
	f_z	x 1,5

HAM 40-1321

Vollhartmetall-Schaftfräser solid carbide end mill

VHM Z 3 30° rechts DIN 6527
Typ N DIN 6535 HA
SHRINK FIT
DIN 6535 HB

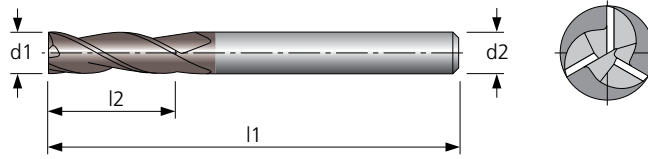

Material	Alu Knet-leg.	Alu Guss-leg.	Stahl < 800 N/mm²	Stahl < 1200 N/mm²	Stahl < 1600 N/mm²	Stahl < 55 HRC	Stahl < 60 HRC	Stahl < 66 HRC	INOX < 800 N/mm²	INOX > 800 N/mm²	GG	GGG	hochw. Legierungen	Titan	NE-Metalle Cu-Leg.	Graphit & Faser-verbund	MMS	max.	ohne	AIR
40-1321		○	●	●	●	○			○	○	●	●	○	○	○	○	●	●	○	○

● sehr gut geeignet / very suitable ○ bedingt geeignet / limited suitable

HAM 40-1321

Werkstoffgruppe material group	Ø mm	3	4	5	6	8	10	12	14	16	18	20
Alu Gusslegierungen	V _c [m/min]	215	215	215	215	215	215	215	215	215	215	215
	f _z [mm]	0,011	0,015	0,019	0,024	0,026	0,034	0,041	0,054	0,064	0,077	0,094
	V _f [mm/min]	780	780	790	830	660	700	700	790	820	870	960
	n [1/min]	22800	17100	13700	11400	8600	6800	5700	4900	4300	3800	3400
Stahl < 800 N/mm²	V _c [m/min]	130	130	130	130	130	130	130	130	130	130	130
	f _z [mm]	0,010	0,013	0,017	0,021	0,022	0,030	0,035	0,046	0,055	0,066	0,081
	V _f [mm/min]	410	410	410	430	340	370	360	420	430	460	510
	n [1/min]	13800	10300	8300	6900	5200	4100	3400	3000	2600	2300	2100
Stahl < 1200 N/mm²	V _c [m/min]	110	110	110	110	110	110	110	110	110	110	110
	f _z [mm]	0,009	0,012	0,015	0,019	0,020	0,027	0,032	0,042	0,050	0,060	0,074
	V _f [mm/min]	320	320	320	330	260	280	280	320	330	340	400
	n [1/min]	11700	8800	7000	5800	4400	3500	2900	2500	2200	1900	1800
Stahl < 1600 N/mm²	V _c [m/min]	95	95	95	95	95	95	95	95	95	95	95
	f _z [mm]	0,008	0,010	0,013	0,016	0,017	0,023	0,027	0,036	0,043	0,051	0,063
	V _f [mm/min]	230	230	230	240	190	210	200	240	240	260	280
	n [1/min]	10100	7600	6000	5000	3800	3000	2500	2200	1900	1700	1500
Stahl < 55 HRC	V _c [m/min]	65	65	65	65	65	65	65	65	65	65	65
	f _z [mm]	0,006	0,008	0,010	0,013	0,013	0,018	0,021	0,028	0,034	0,040	0,050
	V _f [mm/min]	120	130	120	130	100	110	110	130	130	130	150
	n [1/min]	6900	5200	4100	3400	2600	2100	1700	1500	1300	1100	1000
INOX < 800 N/mm²	V _c [m/min]	70	70	70	70	70	70	70	70	70	70	70
	f _z [mm]	0,006	0,008	0,010	0,012	0,013	0,018	0,021	0,027	0,033	0,039	0,048
	V _f [mm/min]	130	130	130	140	110	120	120	130	140	140	160
	n [1/min]	7400	5600	4500	3700	2800	2200	1900	1600	1400	1200	1100
INOX > 800 N/mm²	V _c [m/min]	50	50	50	50	50	50	50	50	50	50	50
	f _z [mm]	0,004	0,005	0,007	0,009	0,009	0,012	0,014	0,019	0,023	0,027	0,033
	V _f [mm/min]	60	60	60	70	50	60	60	60	70	70	80
	n [1/min]	5300	4000	3200	2700	2000	1600	1300	1100	1000	900	800
GG	V _c [m/min]	130	130	130	130	130	130	130	130	130	130	130
	f _z [mm]	0,010	0,013	0,017	0,021	0,022	0,030	0,035	0,046	0,055	0,066	0,081
	V _f [mm/min]	410	410	410	430	340	370	360	420	430	460	510
	n [1/min]	13800	10300	8300	6900	5200	4100	3400	3000	2600	2300	2100
GGG	V _c [m/min]	110	110	110	110	110	110	110	110	110	110	110
	f _z [mm]	0,009	0,012	0,015	0,019	0,020	0,027	0,032	0,042	0,050	0,060	0,074
	V _f [mm/min]	320	320	320	330	260	280	280	320	330	340	400
	n [1/min]	11700	8800	7000	5800	4400	3500	2900	2500	2200	1900	1800
hochwarmfeste Legierungen	V _c [m/min]	35	35	35	35	35	35	35	35	35	35	35
	f _z [mm]	0,006	0,008	0,010	0,012	0,013	0,018	0,021	0,027	0,033	0,039	0,048
	V _f [mm/min]	60	70	60	70	50	60	60	70	70	70	90
	n [1/min]	3700	2800	2200	1900	1400	1100	900	800	700	600	600
Titan	V _c [m/min]	60	60	60	60	60	60	60	60	60	60	60
	f _z [mm]	0,006	0,008	0,010	0,013	0,013	0,018	0,021	0,028	0,034	0,040	0,050
	V _f [mm/min]	120	120	110	120	100	100	100	120	120	130	150
	n [1/min]	6400	4800	3800	3200	2400	1900	1600	1400	1200	1100	1000
NE-Metalle Cu-Legierungen	V _c [m/min]	160	160	160	160	160	160	160	160	160	160	160
	f _z [mm]	0,014	0,018	0,023	0,029	0,030	0,041	0,048	0,063	0,075	0,090	0,111
	V _f [mm/min]	690	690	690	730	580	620	600	680	720	760	830
	n [1/min]	17000	12700	10200	8500	6400	5100	4200	3600	3200	2800	2500

	Alu Guss-leg.	Stahl < 800 N/mm²	Stahl < 1200 N/mm²	Stahl < 1600 N/mm²	Stahl < 55 HRC	INOX < 800 N/mm²	INOX > 800 N/mm²	GG	GGG	hochw. Legierungen	Titan	NE-Metalle Cu-Leg.
	a _p	1 x D	1 x D	1 x D	1 x D	1 x D	0,3 x D	0,3 x D	1 x D	1 x D	0,3 x D	0,3 x D
	a _e	1 x D	1 x D	1 x D	1 x D	1 x D	1 x D	1 x D	1 x D	1 x D	1 x D	1 x D
	a _p	1,5 x D	1,5 x D	1,5 x D	1,5 x D	1,5 x D	1,5 x D	1,5 x D	1,5 x D	1,5 x D	1,5 x D	1,5 x D
	a _e	0,1 x D	0,1 x D	0,1 x D	0,1 x D	0,1 x D	0,1 x D	0,1 x D	0,1 x D	0,1 x D	0,1 x D	0,1 x D
	v _c	x 1,1	x 1,1	x 1,1	x 1,1	x 1,1	x 1,1	x 1,1	x 1,1	x 1,1	x 1,1	x 1,1
	f _z	x 1,5	x 1,5	x 1,5	x 1,5	x 1,5	x 1,5	x 1,5	x 1,5	x 1,5	x 1,5	x 1,5

HAM 40-1360

Vollhartmetall-Schaftfräser mit verdralltem Kühlkanal
solid carbide end mill with interior coolant supply

VHM

Z 3

30° rechts

DIN 6527

Typ N

DIN 6535 PHAK

SHRINK FIT

DIN 6535 HBK

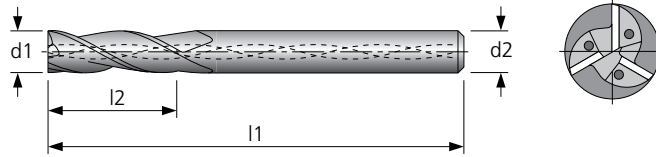

Material	Alu Knet-leg.	Alu Guss-leg.	Stahl < 800 N/mm²	Stahl < 1200 N/mm²	Stahl < 1600 N/mm²	Stahl < 55 HRC	Stahl < 60 HRC	Stahl < 66 HRC	INOX < 800 N/mm²	INOX > 800 N/mm²	GG	GGG	hochw. Legierungen	Titan	NE-Metalle Cu-Leg.	Graphit & Faser-verbund	MMS	max.	ohne	AIR
40-1360		○	●	●	●	○			○	○	●	●	○	○	○	○	●	●	○	○

● sehr gut geeignet / very suitable ○ bedingt geeignet / limited suitable

HAM 40-1360

Werkstoffgruppe material group	Ø mm	8	10	12	14	16	18	20
Alu Gusslegierungen	v_c [m/min]	215	215	215	215	215	215	215
	f_z [mm]	0,026	0,034	0,041	0,054	0,064	0,077	0,094
	v_f [mm/min]	660	700	700	790	820	870	960
	n [1/min]	8600	6800	5700	4900	4300	3800	3400
Stahl < 800 N/mm²	v_c [m/min]	65	65	65	65	65	65	65
	f_z [mm]	0,022	0,030	0,035	0,046	0,055	0,066	0,081
	v_f [mm/min]	170	190	180	210	210	220	240
Stahl < 1200 N/mm²	v_c [m/min]	55	55	55	55	55	55	55
	f_z [mm]	0,020	0,027	0,032	0,042	0,050	0,060	0,074
	v_f [mm/min]	130	150	140	160	170	180	200
Stahl < 1600 N/mm²	v_c [m/min]	50	50	50	50	50	50	50
	f_z [mm]	0,017	0,023	0,027	0,036	0,043	0,051	0,063
	v_f [mm/min]	100	110	110	120	130	140	150
Stahl < 55 HRC	v_c [m/min]	30	30	30	30	30	30	30
	f_z [mm]	0,013	0,018	0,021	0,028	0,034	0,040	0,050
	v_f [mm/min]	50	50	50	60	60	60	70
INOX < 800 N/mm²	v_c [m/min]	35	35	35	35	35	35	35
	f_z [mm]	0,013	0,018	0,021	0,027	0,033	0,039	0,048
	v_f [mm/min]	50	60	60	70	70	70	90
INOX > 800 N/mm²	v_c [m/min]	25	25	25	25	25	25	25
	f_z [mm]	0,009	0,012	0,014	0,019	0,023	0,027	0,033
	v_f [mm/min]	30	30	30	30	30	30	40
GG	v_c [m/min]	70	70	70	70	70	70	70
	f_z [mm]	0,022	0,030	0,035	0,046	0,055	0,066	0,081
	v_f [mm/min]	180	200	200	220	230	240	270
GGG	v_c [m/min]	60	60	60	60	60	60	60
	f_z [mm]	0,020	0,027	0,032	0,042	0,050	0,060	0,074
	v_f [mm/min]	140	150	150	180	180	200	220
hochwarmfeste Legierungen	v_c [m/min]	20	20	20	20	20	20	20
	f_z [mm]	0,013	0,018	0,021	0,027	0,033	0,039	0,048
	v_f [mm/min]	30	30	30	40	40	50	40
Titan	v_c [m/min]	30	30	30	30	30	30	30
	f_z [mm]	0,013	0,018	0,021	0,028	0,034	0,040	0,050
	v_f [mm/min]	50	50	50	60	60	60	70
NE-Metalle Cu-Legierungen	v_c [m/min]	80	80	80	80	80	80	80
	f_z [mm]	0,030	0,041	0,048	0,063	0,075	0,090	0,111
	v_f [mm/min]	290	300	300	340	360	380	430
n [1/min]	3200	2500	2100	1800	1600	1400	1300	

	Alu Guss-leg.	Stahl < 800 N/mm²	Stahl < 1200 N/mm²	Stahl < 1600 N/mm²	Stahl < 55 HRC	INOX < 800 N/mm²	INOX > 800 N/mm²	GG	GGG	hochw. Legierungen	Titan	NE-Metalle Cu-Leg.
	a_p	1 x D	1 x D	1 x D	1 x D	1 x D	0,3 x D	0,3 x D	1 x D	1 x D	0,3 x D	0,3 x D
	a_e	1 x D	1 x D	1 x D	1 x D	1 x D	1 x D	1 x D	1 x D	1 x D	1 x D	1 x D
	a_p	1,5 x D	1,5 x D	1,5 x D	1,5 x D	1,5 x D	1,5 x D	1,5 x D	1,5 x D	1,5 x D	1,5 x D	1,5 x D
	a_e	0,1 x D	0,1 x D	0,1 x D	0,1 x D	0,1 x D	0,1 x D	0,1 x D	0,1 x D	0,1 x D	0,1 x D	0,1 x D
	v_c	x 1,1	x 1,1	x 1,1	x 1,1	x 1,1	x 1,1	x 1,1	x 1,1	x 1,1	x 1,1	x 1,1
	f_z	x 1,5	x 1,5	x 1,5	x 1,5	x 1,5	x 1,5	x 1,5	x 1,5	x 1,5	x 1,5	x 1,5

HAM 40-1400

Vollhartmetall-Schaftfräser
solid carbide end mill

VHM Z3 45° rechts Werk Norm
Typ N HA
SHRINK FIT HB

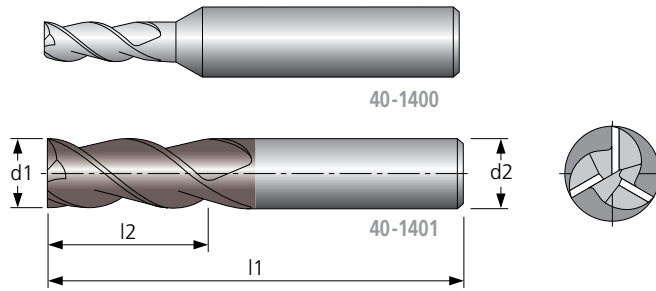

Material	Alu Knetleg.	Alu Gussleg.	Stahl < 800 N/mm²	Stahl < 1200 N/mm²	Stahl < 1600 N/mm²	Stahl < 55 HRC	Stahl < 60 HRC	Stahl < 66 HRC	INOX < 800 N/mm²	INOX > 800 N/mm²	GG	GGG	hochw. Legierungen	Titan	NE-Metalle Cu-Leg.	Graphit & Faser-verbund	MMS	max.	ohne	AIR
40-1400	○	○	●	○	○				●	○	●	○	○	●	○		●	●	○	○
40-1401	○	○	●	●	○				●	●	●	●	○	●	○		●	●	○	○

● sehr gut geeignet / very suitable ○ bedingt geeignet / limited suitable

HAM 40-1400* / 40-1401

* unbeschichtete Werkzeuge HAM 40-1400: $v_c \times 0,5$ (ca.)
* uncoated tools HAM 40-1400: $v_c \times 0,5$ (ca.)

Werkstoffgruppe material group	Ø mm	0,4 – 3	3,5	4	6	8	10	12	14	16	18	20	25
Alu Knetlegierungen	v_c [m/min]	330	330	330	330	330	330	330	330	330	330	330	330
	f_z [mm]	0,008	0,014	0,015	0,023	0,030	0,045	0,054	0,063	0,075	0,090	0,113	0,150
	v_f [mm/min]	1130	1420	1180	1180	1180	1420	1430	1420	1490	1570	1790	1890
	n [1/min]	min. 50000	35000	26300	17500	13100	10500	8800	7500	6600	5800	5300	4200
Alu Gusslegierungen	v_c [m/min]	265	265	265	265	265	265	265	265	265	265	265	265
	f_z [mm]	0,006	0,011	0,013	0,019	0,026	0,038	0,046	0,054	0,064	0,077	0,096	0,128
	v_f [mm/min]	810	970	810	810	800	960	960	960	1010	1080	1200	1300
	n [1/min]	42200	28100	21100	14100	10500	8400	7000	6000	5300	4700	4200	3400
Stahl < 800 N/mm²	v_c [m/min]	130	130	130	130	130	130	130	130	130	130	130	130
	f_z [mm]	0,006	0,010	0,011	0,017	0,022	0,033	0,040	0,046	0,055	0,066	0,083	0,110
	v_f [mm/min]	340	410	340	340	340	410	400	420	430	460	520	560
	n [1/min]	20700	13800	10300	6900	5200	4100	3400	3000	2600	2300	2100	1700
Stahl < 1200 N/mm²	v_c [m/min]	110	110	110	110	110	110	110	110	110	110	110	110
	f_z [mm]	0,005	0,009	0,010	0,015	0,020	0,030	0,036	0,042	0,050	0,060	0,075	0,100
	v_f [mm/min]	260	320	260	260	260	320	310	320	330	340	410	420
	n [1/min]	17500	11700	8800	5800	4400	3500	2900	2500	2200	1900	1800	1400
Stahl < 1600 N/mm²	v_c [m/min]	95	95	95	95	95	95	95	95	95	95	95	95
	f_z [mm]	0,004	0,008	0,009	0,013	0,017	0,026	0,031	0,036	0,043	0,051	0,064	0,085
	v_f [mm/min]	190	230	190	190	190	230	230	240	240	260	290	310
	n [1/min]	15100	10100	7600	5000	3800	3000	2500	2200	1900	1700	1500	1200
INOX < 800 N/mm²	v_c [m/min]	70	70	70	70	70	70	70	70	70	70	70	70
	f_z [mm]	0,004	0,007	0,008	0,012	0,016	0,024	0,029	0,034	0,040	0,048	0,060	0,080
	v_f [mm/min]	130	160	130	130	130	160	160	160	170	170	200	220
	n [1/min]	11100	7400	5600	3700	2800	2200	1900	1600	1400	1200	1100	900
INOX > 800 N/mm²	v_c [m/min]	50	50	50	50	50	50	50	50	50	50	50	50
	f_z [mm]	0,003	0,006	0,007	0,010	0,013	0,020	0,024	0,028	0,034	0,040	0,050	0,067
	v_f [mm/min]	80	100	80	80	80	100	90	90	100	110	120	120
	n [1/min]	8000	5300	4000	2700	2000	1600	1300	1100	1000	900	800	600
GG	v_c [m/min]	130	130	130	130	130	130	130	130	130	130	130	130
	f_z [mm]	0,006	0,010	0,011	0,017	0,022	0,033	0,040	0,046	0,055	0,066	0,083	0,110
	v_f [mm/min]	340	410	340	340	340	410	400	420	430	460	520	560
	n [1/min]	20700	13800	10300	6900	5200	4100	3400	3000	2600	2300	2100	1700
GGG	v_c [m/min]	110	110	110	110	110	110	110	110	110	110	110	110
	f_z [mm]	0,005	0,009	0,010	0,015	0,020	0,030	0,036	0,042	0,050	0,060	0,075	0,100
	v_f [mm/min]	260	320	260	260	260	320	310	320	330	340	410	420
	n [1/min]	17500	11700	8800	5800	4400	3500	2900	2500	2200	1900	1800	1400
hochwärmfeste Legierungen	v_c [m/min]	35	35	35	35	35	35	35	35	35	35	35	35
	f_z [mm]	0,003	0,006	0,007	0,010	0,013	0,020	0,023	0,027	0,033	0,039	0,049	0,065
	v_f [mm/min]	50	60	50	60	50	60	60	70	70	70	90	80
	n [1/min]	5600	3700	2800	1900	1400	1100	900	800	700	600	600	400
Titan	v_c [m/min]	60	60	60	60	60	60	60	60	60	60	60	60
	f_z [mm]	0,003	0,006	0,007	0,010	0,013	0,020	0,024	0,028	0,034	0,040	0,050	0,067
	v_f [mm/min]	100	120	100	100	100	110	120	120	120	130	150	160
	n [1/min]	9500	6400	4800	3200	2400	1900	1600	1400	1200	1100	1000	800
NE-Metalle Cu-Legierungen	v_c [m/min]	200	200	200	200	200	200	200	200	200	200	200	200
	f_z [mm]	0,008	0,014	0,015	0,023	0,030	0,045	0,054	0,063	0,075	0,090	0,113	0,150
	v_f [mm/min]	720	860	720	720	720	860	860	850	900	950	1080	1130
	n [1/min]	31800	21200	15900	10600	8000	6400	5300	4500	4000	3500	3200	2500

	a_p	1 x D
	a_e	1 x D
	v_c	x 1
	f_z	x 1

	a_p	1,5 x D
	a_e	0,1 x D
	v_c	x 1,1
	f_z	x 2

HAM 40-1440

Vollhartmetall-Schaftfräser
solid carbide end mill

VHM Z 4 30° rechts Werk Norm
Typ N HA
SHRINK FIT

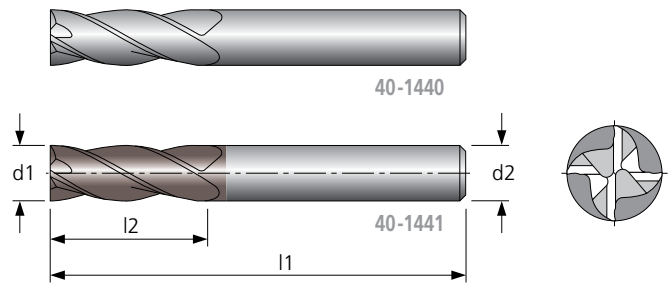



Material	Alu Knet-leg.	Alu Guss-leg.	Stahl < 800 N/mm²	Stahl < 1200 N/mm²	Stahl < 1600 N/mm²	Stahl < 55 HRC	Stahl < 60 HRC	Stahl < 66 HRC	INOX < 800 N/mm²	INOX > 800 N/mm²	GG	GGG	hochw. Legierungen	Titan	NE-Metalle Cu-Leg.	Graphit & Faser-verbund	MMS	max.	ohne	AIR
40-1440	○	○	●	○	○	○			○	○	●	○	○	○	○	○	●	●	○	○
40-1441		○	●	●	●	○			○	○	●	●	○	○	○	○	●	●	○	○



● sehr gut geeignet / very suitable ○ bedingt geeignet / limited suitable

HAM 40-1440* / 40-1441

* unbeschichtete Werkzeuge HAM 40-1440: $v_c \times 0,5$ (ca.)
* uncoated tools HAM 40-1440: $v_c \times 0,5$ (ca.)

Werkstoffgruppe material group	Ø mm	2	4	6	8	10	12	14	16	18	20
Alu Knetlegierungen	v_c [m/min]	300	300	300	300	300	300	300	300	300	300
	f_z [mm]	0,070	0,090	0,130	0,170	0,210	0,250	0,290	0,320	0,360	0,400
	v_f [mm/min]	13360	8600	8270	8090	7980	8000	7890	7680	7630	7680
	n [1/min]	47700	23900	15900	11900	9500	8000	6800	6000	5300	4800
Alu Gusslegierungen	v_c [m/min]	250	250	250	250	250	250	250	250	250	250
	f_z [mm]	0,050	0,072	0,100	0,136	0,168	0,200	0,230	0,250	0,290	0,320
	v_f [mm/min]	7960	5730	5320	5390	5380	5280	5240	5000	5100	5120
	n [1/min]	39800	19900	13300	9900	8000	6600	5700	5000	4400	4000
Stahl < 800 N/mm²	v_c [m/min]	155	155	155	155	155	155	155	155	155	155
	f_z [mm]	0,020	0,029	0,037	0,055	0,072	0,099	0,110	0,143	0,143	0,176
	v_f [mm/min]	1960	1410	1230	1360	1400	1620	1540	1770	1540	1760
	n [1/min]	24700	12300	8200	6200	4900	4100	3500	3100	2700	2500
Stahl < 1200 N/mm²	v_c [m/min]	130	130	130	130	130	130	130	130	130	130
	f_z [mm]	0,018	0,026	0,034	0,050	0,065	0,090	0,100	0,130	0,130	0,160
	v_f [mm/min]	1490	1070	940	1040	1070	1220	1200	1350	1200	1340
	n [1/min]	20700	10300	6900	5200	4100	3400	3000	2600	2300	2100
Stahl < 1600 N/mm²	v_c [m/min]	110	110	110	110	110	110	110	110	110	110
	f_z [mm]	0,015	0,022	0,029	0,043	0,055	0,077	0,085	0,111	0,111	0,136
	v_f [mm/min]	1070	780	670	750	770	890	850	970	840	980
	n [1/min]	17500	8800	5800	4400	3500	2900	2500	2200	1900	1800
Stahl < 55 HRC	v_c [m/min]	80	80	80	80	80	80	80	80	80	80
	f_z [mm]	0,012	0,017	0,023	0,034	0,044	0,060	0,067	0,087	0,087	0,107
	v_f [mm/min]	610	450	380	430	440	510	480	560	490	560
	n [1/min]	12700	6400	4200	3200	2500	2100	1800	1600	1400	1300
INOX < 800 N/mm²	v_c [m/min]	85	85	85	85	85	85	85	85	85	85
	f_z [mm]	0,014	0,021	0,027	0,040	0,052	0,072	0,080	0,104	0,104	0,128
	v_f [mm/min]	780	570	490	540	560	660	610	710	620	720
	n [1/min]	13500	6800	4500	3400	2700	2300	1900	1700	1500	1400
INOX > 800 N/mm²	v_c [m/min]	60	60	60	60	60	60	60	60	60	60
	f_z [mm]	0,012	0,020	0,026	0,038	0,048	0,060	0,074	0,087	0,100	0,120
	v_f [mm/min]	470	380	330	360	360	380	410	420	440	480
	n [1/min]	9500	4800	3200	2400	1900	1600	1400	1200	1100	1000
GG	v_c [m/min]	150	150	150	150	150	150	150	150	150	150
	f_z [mm]	0,020	0,029	0,037	0,055	0,072	0,099	0,110	0,143	0,143	0,176
	v_f [mm/min]	1890	1360	1200	1320	1370	1580	1500	1720	1540	1690
	n [1/min]	23900	11900	8000	6000	4800	4000	3400	3000	2700	2400
GGG	v_c [m/min]	130	130	130	130	130	130	130	130	130	130
	f_z [mm]	0,018	0,026	0,034	0,050	0,065	0,090	0,100	0,130	0,130	0,160
	v_f [mm/min]	1490	1070	940	1040	1070	1220	1200	1350	1200	1340
	n [1/min]	20700	10300	6900	5200	4100	3400	3000	2600	2300	2100
hochwärmfeste Legierungen	v_c [m/min]	40	40	40	40	40	40	40	40	40	40
	f_z [mm]	0,012	0,017	0,022	0,033	0,042	0,059	0,065	0,085	0,085	0,104
	v_f [mm/min]	300	220	190	210	220	260	230	270	240	250
	n [1/min]	6400	3200	2100	1600	1300	1100	900	800	700	600
Titan	v_c [m/min]	70	70	70	70	70	70	70	70	70	70
	f_z [mm]	0,012	0,017	0,023	0,034	0,044	0,060	0,067	0,087	0,087	0,107
	v_f [mm/min]	540	390	340	380	380	460	430	490	420	470
	n [1/min]	11100	5600	3700	2800	2200	1900	1600	1400	1200	1100
NE-Metalle Cu-Legierungen	v_c [m/min]	210	210	210	210	210	210	210	210	210	210
	f_z [mm]	0,030	0,054	0,078	0,102	0,126	0,150	0,174	0,192	0,216	0,240
	v_f [mm/min]	4010	3610	3460	3430	3380	3360	3340	3230	3200	3170
	n [1/min]	33400	16700	11100	8400	6700	5600	4800	4200	3700	3300

		Alu Knet-leg.	Alu Guss-leg.	Stahl < 800 N/mm ²	Stahl < 1200 N/mm ²	Stahl < 1600 N/mm ²	Stahl < 55 HRC
	\bar{a}_p	1,5 x D	1,5 x D	1,5 x D	1,5 x D	1,5 x D	1,5 x D
	\bar{a}_e	0,04 x D	0,04 x D	0,04 x D	0,04 x D	0,04 x D	0,04 x D
	\bar{a}_p	1 x D	1 x D	1 x D	1 x D	1 x D	1 x D
	\bar{a}_e	1 x D	1 x D	1 x D	1 x D	1 x D	1 x D
	v_c	x 0,8	x 0,8	x 0,8	x 0,8	x 0,8	x 0,8
	f_z	x 0,5	x 0,5	x 0,5	x 0,5	x 0,5	x 0,5

		INOX < 800 N/mm ²	INOX > 800 N/mm ²	GG	GGG	hochw. Legierungen	Titan	NE-Metalle Cu-Leg.
	\bar{a}_p	1,5 x D	1,5 x D	1,5 x D	1,5 x D	1,5 x D	1,5 x D	1,5 x D
	\bar{a}_e	0,04 x D	0,04 x D	0,04 x D	0,04 x D	0,04 x D	0,04 x D	0,04 x D
	\bar{a}_p	1 x D	1 x D	1 x D	1 x D	1 x D	1 x D	1 x D
	\bar{a}_e	1 x D	1 x D	1 x D	1 x D	1 x D	1 x D	1 x D
	v_c	x 0,8	x 0,8	x 0,8	x 0,8	x 0,8	x 0,8	x 0,8
	f_z	x 0,5	x 0,5	x 0,5	x 0,5	x 0,5	x 0,5	x 0,5

HAM 40-5151

**Vollhartmetall-Schaftfräser
solid carbide end mill**

W+F VHM Z 4 35°/38° re DIN 6527
Typ N DIN 6535 HA
HSF HPC SHRINK FIT
DIN 6535 HB

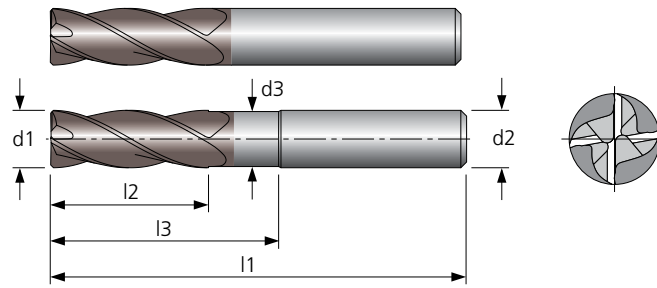

Material	Alu Knet-leg.	Alu Guss-leg.	Stahl < 800 N/mm²	Stahl < 1200 N/mm²	Stahl < 1600 N/mm²	Stahl < 55 HRC	Stahl < 60 HRC	Stahl < 66 HRC	INOX < 800 N/mm²	INOX > 800 N/mm²	GG	GGG	hochw. Legierungen	Titan	NE-Metalle Cu-Leg.	Graphit & Faser-verbund	MMS	max.	ohne	AIR
40-5151	○	○	●	●	●				●	●	●	●	○	○	○	○	●	●	○	○

● sehr gut geeignet / very suitable ○ bedingt geeignet / limited suitable

HAM 40-5151

Werkstoffgruppe material group	Ø mm	3-4	5	6	7	8	10	12	14	16	18	20	25-26
Alu Knetlegierungen	Vc [m/min]	400	400	400	400	400	400	400	400	400	400	400	400
	fz [mm]	0,060	0,070	0,080	0,090	0,110	0,140	0,180	0,220	0,260	0,300	0,360	0,500
	Vf [mm/min]	7630	7140	6780	6550	7000	7110	7630	8010	8320	8520	9220	10200
	n [1/min]	31800	25500	21200	18200	15900	12700	10600	9100	8000	7100	6400	5100
Alu Gusslegierungen	Vc [m/min]	320	320	320	320	320	320	320	320	320	320	320	320
	fz [mm]	0,051	0,060	0,068	0,077	0,094	0,119	0,153	0,187	0,221	0,255	0,306	0,425
	Vf [mm/min]	5200	4860	4620	4470	4750	4860	5200	5460	5660	5810	6240	6970
	n [1/min]	25500	20400	17000	14600	12700	10200	8500	7300	6400	5700	5100	4100
Stahl < 800 N/mm²	Vc [m/min]	155	155	155	155	155	155	155	155	155	155	155	155
	fz [mm]	0,033	0,039	0,044	0,050	0,061	0,077	0,099	0,121	0,143	0,165	0,198	0,275
	Vf [mm/min]	1620	1520	1440	1390	1500	1510	1620	1690	1770	1780	1980	2200
	n [1/min]	12300	9900	8200	7000	6200	4900	4100	3500	3100	2700	2500	2000
Stahl < 1200 N/mm²	Vc [m/min]	130	130	130	130	130	130	130	130	130	130	130	130
	fz [mm]	0,030	0,035	0,040	0,045	0,055	0,070	0,090	0,110	0,130	0,150	0,180	0,250
	Vf [mm/min]	1240	1160	1100	1060	1140	1150	1220	1320	1350	1380	1510	1700
	n [1/min]	10300	8300	6900	5900	5200	4100	3400	3000	2600	2300	2100	1700
Stahl < 1600 N/mm²	Vc [m/min]	110	110	110	110	110	110	110	110	110	110	110	110
	fz [mm]	0,026	0,030	0,034	0,038	0,047	0,060	0,077	0,094	0,111	0,128	0,153	0,213
	Vf [mm/min]	900	830	790	770	820	830	890	940	970	970	1100	1190
	n [1/min]	8800	7000	5800	5000	4400	3500	2900	2500	2200	1900	1800	1400
INOX < 800 N/mm²	Vc [m/min]	85	85	85	85	85	85	85	85	85	85	85	85
	fz [mm]	0,024	0,028	0,032	0,036	0,044	0,056	0,072	0,088	0,104	0,120	0,144	0,200
	Vf [mm/min]	640	600	580	550	600	600	630	670	710	720	750	880
	n [1/min]	6700	5400	4500	3800	3400	2700	2200	1900	1700	1500	1300	1100
INOX > 800 N/mm²	Vc [m/min]	60	60	60	60	60	60	60	60	60	60	60	60
	fz [mm]	0,020	0,023	0,027	0,030	0,037	0,047	0,060	0,074	0,087	0,101	0,121	0,168
	Vf [mm/min]	390	360	340	330	350	360	390	410	420	440	480	540
	n [1/min]	4800	3800	3200	2700	2400	1900	1600	1400	1200	1100	1000	800
GG	Vc [m/min]	150	150	150	150	150	150	150	150	150	150	150	150
	fz [mm]	0,033	0,039	0,044	0,050	0,061	0,077	0,099	0,121	0,143	0,165	0,198	0,275
	Vf [mm/min]	1570	1460	1390	1350	1430	1480	1580	1650	1720	1720	1900	2090
	n [1/min]	11900	9500	7900	6800	5900	4800	4000	3400	3000	2600	2400	1900
GGG	Vc [m/min]	130	130	130	130	130	130	130	130	130	130	130	130
	fz [mm]	0,030	0,035	0,040	0,045	0,055	0,070	0,090	0,110	0,130	0,150	0,180	0,250
	Vf [mm/min]	1240	1160	1100	1060	1140	1150	1220	1320	1350	1380	1510	1700
	n [1/min]	10300	8300	6900	5900	5200	4100	3400	3000	2600	2300	2100	1700
hochwarmfeste Legierungen	Vc [m/min]	40	40	40	40	40	40	40	40	40	40	40	40
	fz [mm]	0,020	0,023	0,026	0,029	0,036	0,046	0,059	0,072	0,085	0,098	0,117	0,163
	Vf [mm/min]	250	230	220	210	230	240	260	260	270	270	280	330
	n [1/min]	3200	2500	2100	1800	1600	1300	1100	900	800	700	600	500
Titan	Vc [m/min]	70	70	70	70	70	70	70	70	70	70	70	70
	fz [mm]	0,020	0,023	0,027	0,030	0,037	0,047	0,060	0,074	0,087	0,101	0,121	0,168
	Vf [mm/min]	450	420	400	390	410	410	460	470	490	480	530	600
	n [1/min]	5600	4500	3700	3200	2800	2200	1900	1600	1400	1200	1100	900
NE-Metalle Cu-Legierungen	Vc [m/min]	260	260	260	260	260	260	260	260	260	260	260	260
	fz [mm]	0,060	0,070	0,080	0,090	0,110	0,140	0,180	0,220	0,260	0,300	0,360	0,500
	Vf [mm/min]	4970	4650	4420	4250	4530	4650	4970	5190	5410	5520	5900	6600
	n [1/min]	20700	16600	13800	11800	10300	8300	6900	5900	5200	4600	4100	3300

	Alu Knet-leg.	Alu Guss-leg.	Stahl < 800 N/mm²	Stahl < 1200 N/mm²	Stahl < 1600 N/mm²	INOX < 800 N/mm²	INOX > 800 N/mm²	GG	GGG	hochw. Legierungen	Titan	NE-Metalle Cu-Leg.
ap	1,5 x D	1,5 x D	1,5 x D	1,5 x D	1,5 x D	1,5 x D	1,5 x D	1,5 x D	1,5 x D	1,5 x D	1,5 x D	1,5 x D
ae	0,04 x D	0,04 x D	0,04 x D	0,04 x D	0,04 x D	0,04 x D	0,04 x D	0,04 x D	0,04 x D	0,04 x D	0,04 x D	0,04 x D
ap	1 x D	1 x D	1 x D	1 x D	1 x D	1 x D	1 x D	1 x D	1 x D	1 x D	1 x D	1 x D
ae	1 x D	1 x D	1 x D	1 x D	1 x D	1 x D	1 x D	1 x D	1 x D	1 x D	1 x D	1 x D
Vc	x 0,8	x 0,8	x 0,8	x 0,8	x 0,8	x 0,8	x 0,8	x 0,8	x 0,8	x 0,8	x 0,8	x 0,8
fz	x 0,5	x 0,5	x 0,5	x 0,5	x 0,5	x 0,5	x 0,5	x 0,5	x 0,5	x 0,5	x 0,5	x 0,5

HAM 40-5181

Vollhartmetall-Schaftfräser
solid carbide end mill

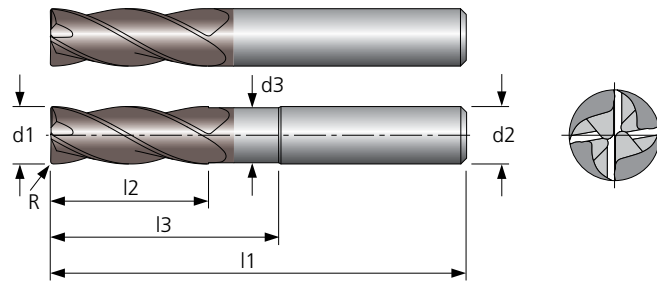
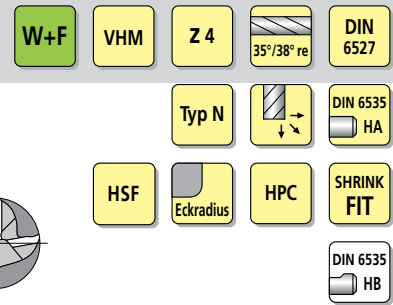

Material	Alu Knet-leg.	Alu Guss-leg.	Stahl < 800 N/mm²	Stahl < 1200 N/mm²	Stahl < 1600 N/mm²	Stahl < 55 HRC	Stahl < 60 HRC	Stahl < 66 HRC	INOX < 800 N/mm²	INOX > 800 N/mm²	GG	GGG	hochw. Legierungen	Titan	NE-Metalle Cu-Leg.	Graphit & Faser-verbund	MMS	max.	ohne	AIR
40-5181	○	○	●	●	●				●	●	●	●	○	○	○	○	●	●	○	○

● sehr gut geeignet / very suitable ○ bedingt geeignet / limited suitable

HAM 40-5181

Werkstoffgruppe material group	Ø mm	4	5	6	8	10	12	16	20
Alu Knetlegierungen	V _c [m/min]	400	400	400	400	400	400	400	400
	f _z [mm]	0,060	0,070	0,080	0,110	0,140	0,180	0,260	0,360
	V _f [mm/min]	7630	7140	6780	7000	7110	7630	8320	9220
	n [1/min]	31800	25500	21200	15900	12700	10600	8000	6400
Alu Gusslegierungen	V _c [m/min]	320	320	320	320	320	320	320	320
	f _z [mm]	0,051	0,060	0,068	0,094	0,119	0,153	0,221	0,306
	V _f [mm/min]	5200	4860	4620	4750	4860	5200	5660	6240
	n [1/min]	25500	20400	17000	12700	10200	8500	6400	5100
Stahl < 800 N/mm²	V _c [m/min]	155	155	155	155	155	155	155	155
	f _z [mm]	0,033	0,039	0,044	0,061	0,077	0,099	0,143	0,198
	V _f [mm/min]	1620	1520	1440	1500	1510	1620	1770	1980
	n [1/min]	12300	9900	8200	6200	4900	4100	3100	2500
Stahl < 1200 N/mm²	V _c [m/min]	130	130	130	130	130	130	130	130
	f _z [mm]	0,030	0,035	0,040	0,055	0,070	0,090	0,130	0,180
	V _f [mm/min]	1240	1160	1100	1140	1150	1220	1350	1510
	n [1/min]	10300	8300	6900	5200	4100	3400	2600	2100
Stahl < 1600 N/mm²	V _c [m/min]	110	110	110	110	110	110	110	110
	f _z [mm]	0,026	0,030	0,034	0,047	0,060	0,077	0,111	0,153
	V _f [mm/min]	900	830	790	820	830	890	970	1100
	n [1/min]	8800	7000	5800	4400	3500	2900	2200	1800
INOX < 800 N/mm²	V _c [m/min]	85	85	85	85	85	85	85	85
	f _z [mm]	0,024	0,028	0,032	0,044	0,056	0,072	0,104	0,144
	V _f [mm/min]	640	600	580	600	600	630	710	750
	n [1/min]	6700	5400	4500	3400	2700	2200	1700	1300
INOX > 800 N/mm²	V _c [m/min]	60	60	60	60	60	60	60	60
	f _z [mm]	0,020	0,023	0,027	0,037	0,047	0,060	0,087	0,121
	V _f [mm/min]	390	360	340	350	360	390	420	480
	n [1/min]	4800	3800	3200	2400	1900	1600	1200	1000
GG	V _c [m/min]	150	150	150	150	150	150	150	150
	f _z [mm]	0,033	0,039	0,044	0,061	0,077	0,099	0,143	0,198
	V _f [mm/min]	1570	1460	1390	1430	1480	1580	1720	1900
	n [1/min]	11900	9500	7900	5900	4800	4000	3000	2400
GGG	V _c [m/min]	130	130	130	130	130	130	130	130
	f _z [mm]	0,030	0,035	0,040	0,055	0,070	0,090	0,130	0,180
	V _f [mm/min]	1240	1160	1100	1140	1150	1220	1350	1510
	n [1/min]	10300	8300	6900	5200	4100	3400	2600	2100
hochwarmfeste Legierungen	V _c [m/min]	40	40	40	40	40	40	40	40
	f _z [mm]	0,020	0,023	0,026	0,036	0,046	0,059	0,085	0,117
	V _f [mm/min]	250	230	220	230	240	260	270	280
	n [1/min]	3200	2500	2100	1600	1300	1100	800	600
Titan	V _c [m/min]	70	70	70	70	70	70	70	70
	f _z [mm]	0,020	0,023	0,027	0,037	0,047	0,060	0,087	0,121
	V _f [mm/min]	450	420	400	410	410	460	490	530
	n [1/min]	5600	4500	3700	2800	2200	1900	1400	1100
NE-Metalle Cu-Legierungen	V _c [m/min]	260	260	260	260	260	260	260	260
	f _z [mm]	0,060	0,070	0,080	0,110	0,140	0,180	0,260	0,360
	V _f [mm/min]	4970	4650	4420	4530	4650	4970	5410	5900
	n [1/min]	20700	16600	13800	10300	8300	6900	5200	4100

	▽	▽▽
ap	1,5 x D	1,5 x D
ae	0,5 x D	0,04 x D
vc	x 0,9	x 1
fz	x 0,85	x 1

	▽
ap	1 x D
ae	1 x D
vc	x 0,85
fz	x 0,5

HAM 40-1491

Vollhartmetall-Schaftfräser
solid carbide end mill

W+F VHM Z 4 35°/38° re DIN 6527
Typ N HA DIN 6535
HSF HSC HPC SHRINK FIT
HB DIN 6535

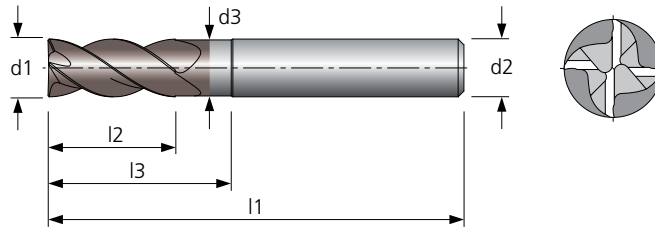

Material	Alu Knet-leg.	Alu Guss-leg.	Stahl < 800 N/mm²	Stahl < 1200 N/mm²	Stahl < 1600 N/mm²	Stahl < 55 HRC	Stahl < 60 HRC	Stahl < 66 HRC	INOX < 800 N/mm²	INOX > 800 N/mm²	GG	GGG	hochw. Legierungen	Titan	NE-Metalle Cu-Leg.	Graphit & Faser-verbund	MMS	max.	ohne	AIR
40-1491	○	○	●	●	●				●	●	●	●	○	●	○	○	●	●	○	○

● sehr gut geeignet / very suitable ○ bedingt geeignet / limited suitable

HAM 40-1491

Werkstoffgruppe material group	Ø mm	3	4	5	6	8	10	12	16	20
Alu Knetlegierungen	v _c [m/min]	400	400	400	400	400	400	400	400	400
	f _z [mm]	0,040	0,050	0,060	0,080	0,100	0,130	0,160	0,230	0,300
	v _f [mm/min]	6780	6360	6120	6780	6360	6600	6780	7360	7680
	n [1/min]	42400	31800	25500	21200	15900	12700	10600	8000	6400
Alu Gusslegierungen	v _c [m/min]	320	320	320	320	320	320	320	320	320
	f _z [mm]	0,040	0,050	0,060	0,070	0,095	0,120	0,150	0,220	0,300
	v _f [mm/min]	5440	5100	4900	4760	4830	4900	5100	5630	6120
	n [1/min]	34000	25500	20400	17000	12700	10200	8500	6400	5100
Stahl < 800 N/mm²	v _c [m/min]	155	155	155	155	155	155	155	155	155
	f _z [mm]	0,030	0,035	0,040	0,045	0,060	0,075	0,100	0,140	0,200
	v _f [mm/min]	1970	1720	1580	1480	1490	1470	1640	1740	2000
	n [1/min]	16400	12300	9900	8200	6200	4900	4100	3100	2500
Stahl < 1200 N/mm²	v _c [m/min]	130	130	130	130	130	130	130	130	130
	f _z [mm]	0,025	0,030	0,035	0,040	0,055	0,070	0,090	0,130	0,180
	v _f [mm/min]	1380	1240	1160	1100	1140	1150	1220	1350	1510
	n [1/min]	13800	10300	8300	6900	5200	4100	3400	2600	2100
Stahl < 1600 N/mm²	v _c [m/min]	110	110	110	110	110	110	110	110	110
	f _z [mm]	0,020	0,025	0,030	0,035	0,045	0,060	0,077	0,110	0,150
	v _f [mm/min]	940	880	840	810	790	840	890	970	1080
	n [1/min]	11700	8800	7000	5800	4400	3500	2900	2200	1800
INOX < 800 N/mm²	v _c [m/min]	85	85	85	85	85	85	85	85	85
	f _z [mm]	0,020	0,025	0,030	0,035	0,045	0,055	0,070	0,100	0,140
	v _f [mm/min]	720	680	650	630	610	590	640	680	780
	n [1/min]	9000	6800	5400	4500	3400	2700	2300	1700	1400
INOX > 800 N/mm²	v _c [m/min]	60	60	60	60	60	60	60	60	60
	f _z [mm]	0,015	0,020	0,025	0,030	0,040	0,050	0,060	0,090	0,120
	v _f [mm/min]	380	380	380	380	380	380	380	430	480
	n [1/min]	6400	4800	3800	3200	2400	1900	1600	1200	1000
GG	v _c [m/min]	150	150	150	150	150	150	150	150	150
	f _z [mm]	0,030	0,035	0,040	0,045	0,060	0,080	0,100	0,140	0,200
	v _f [mm/min]	1910	1670	1520	1440	1440	1540	1600	1680	1920
	n [1/min]	15900	11900	9500	8000	6000	4800	4000	3000	2400
GGG	v _c [m/min]	130	130	130	130	130	130	130	130	130
	f _z [mm]	0,025	0,030	0,035	0,040	0,055	0,070	0,090	0,130	0,180
	v _f [mm/min]	1380	1240	1160	1100	1140	1150	1220	1350	1510
	n [1/min]	13800	10300	8300	6900	5200	4100	3400	2600	2100
hochwarmfeste Legierungen	v _c [m/min]	40	40	40	40	40	40	40	40	40
	f _z [mm]	0,015	0,020	0,025	0,030	0,035	0,045	0,060	0,085	0,120
	v _f [mm/min]	250	260	250	250	220	230	260	270	290
	n [1/min]	4200	3200	2500	2100	1600	1300	1100	800	600
Titan	v _c [m/min]	70	70	70	70	70	70	70	70	70
	f _z [mm]	0,015	0,020	0,030	0,035	0,040	0,050	0,070	0,090	0,120
	v _f [mm/min]	440	450	540	520	450	440	530	500	530
	n [1/min]	7400	5600	4500	3700	2800	2200	1900	1400	1100
NE-Metalle Cu-Legierungen	v _c [m/min]	260	260	260	260	260	260	260	260	260
	f _z [mm]	0,050	0,060	0,070	0,080	0,110	0,140	0,180	0,260	0,360
	v _f [mm/min]	5520	4970	4650	4420	4530	4650	4970	5410	5900
	n [1/min]	27600	20700	16600	13800	10300	8300	6900	5200	4100

	Alu Knet-leg.	Alu Guss-leg.	Stahl < 800 N/mm²	Stahl < 1200 N/mm²	Stahl < 1600 N/mm²	INOX < 800 N/mm²	INOX > 800 N/mm²	GG	GGG	hochw. Legierungen	Titan	NE-Metalle Cu-Leg.
ap	1,5 x D	1,5 x D	1,5 x D	1,5 x D	1,5 x D	1,5 x D	1,5 x D	1,5 x D	1,5 x D	1,5 x D	1,5 x D	1,5 x D
ae	0,04 x D	0,04 x D	0,04 x D	0,04 x D	0,04 x D	0,04 x D	0,04 x D	0,04 x D	0,04 x D	0,04 x D	0,04 x D	0,04 x D
ap	1 x D	1 x D	1 x D	1 x D	1 x D	1 x D	1 x D	1 x D	1 x D	1 x D	1 x D	1 x D
ae	1 x D	1 x D	1 x D	1 x D	1 x D	1 x D	1 x D	1 x D	1 x D	1 x D	1 x D	1 x D
v _c	x 0,8	x 0,8	x 0,8	x 0,8	x 0,8	x 0,8	x 0,8	x 0,8	x 0,8	x 0,8	x 0,8	x 0,8
f _z	x 0,5	x 0,5	x 0,5	x 0,5	x 0,5	x 0,5	x 0,5	x 0,5	x 0,5	x 0,5	x 0,5	x 0,5

HAM 40-1521

Vollhartmetall-Schaftfräser
solid carbide end mill

VHM Z4 45° rechts DIN 6527
Typ N DIN 6535 HA
HSF SHRINK FIT
DIN 6535 HB

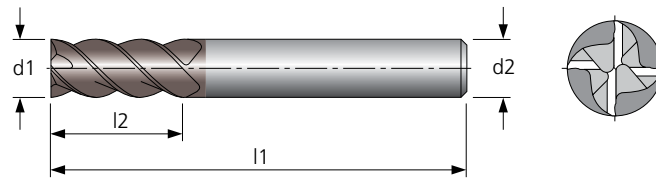

Material	Alu Knet-leg.	Alu Guss-leg.	Stahl < 800 N/mm²	Stahl < 1200 N/mm²	Stahl < 1600 N/mm²	Stahl < 55 HRC	Stahl < 60 HRC	Stahl < 66 HRC	INOX < 800 N/mm²	INOX > 800 N/mm²	GG	GGG	hochw. Legie-rungen	Titan	NE-Metalle Cu-Leg.	Graphit & Faser-verbund	MMS	max.	ohne	AIR
40-1521	○	○	●	●	○				●	●	●	●	○	●	○	○	●	●	○	○

● sehr gut geeignet / very suitable ○ bedingt geeignet / limited suitable

HAM 40-1521

Werkstoffgruppe material group	Ø mm	3	4	5	6	8	10	12	14	16	18	20	25
Alu Knetlegierungen	v_c [m/min]	300	300	300	300	300	300	300	300	300	300	300	300
	f_z [mm]	0,080	0,090	0,110	0,130	0,170	0,210	0,250	0,290	0,320	0,360	0,400	0,450
	v_f [mm/min]	10180	8600	8400	8270	8090	7980	8000	7890	7680	7630	7680	6840
	n [1/min]	31800	23900	19100	15900	11900	9500	8000	6800	6000	5300	4800	3800
Alu Gusslegierungen	v_c [m/min]	250	250	250	250	250	250	250	250	250	250	250	250
	f_z [mm]	0,064	0,072	0,088	0,100	0,136	0,168	0,200	0,230	0,250	0,290	0,320	0,360
	v_f [mm/min]	6780	5730	5600	5320	5390	5380	5280	5240	5000	5100	5120	4610
	n [1/min]	26500	19900	15900	13300	9900	8000	6600	5700	5000	4400	4000	3200
Stahl < 800 N/mm²	v_c [m/min]	155	155	155	155	155	155	155	155	155	155	155	155
	f_z [mm]	0,028	0,033	0,039	0,046	0,063	0,079	0,099	0,121	0,140	0,165	0,200	0,230
	v_f [mm/min]	1800	1620	1520	1520	1550	1550	1620	1690	1740	1780	2000	1840
	n [1/min]	16400	12300	9900	8200	6200	4900	4100	3500	3100	2700	2500	2000
Stahl < 1200 N/mm²	v_c [m/min]	130	130	130	130	130	130	130	130	130	130	130	130
	f_z [mm]	0,025	0,030	0,035	0,042	0,057	0,072	0,090	0,110	0,130	0,150	0,180	0,210
	v_f [mm/min]	1380	1240	1160	1160	1190	1180	1220	1320	1350	1380	1510	1430
	n [1/min]	13800	10300	8300	6900	5200	4100	3400	3000	2600	2300	2100	1700
Stahl < 1600 N/mm²	v_c [m/min]	110	110	110	110	110	110	110	110	110	110	110	110
	f_z [mm]	0,021	0,026	0,030	0,036	0,048	0,061	0,077	0,094	0,110	0,130	0,150	0,180
	v_f [mm/min]	990	900	830	830	850	860	890	940	970	990	1080	1010
	n [1/min]	11700	8800	7000	5800	4400	3500	2900	2500	2200	1900	1800	1400
INOX < 800 N/mm²	v_c [m/min]	85	85	85	85	85	85	85	85	85	85	85	85
	f_z [mm]	0,020	0,024	0,028	0,034	0,046	0,058	0,072	0,090	0,100	0,120	0,140	0,170
	v_f [mm/min]	720	650	600	600	620	620	660	680	680	720	780	750
	n [1/min]	9000	6800	5400	4500	3400	2700	2300	1900	1700	1500	1400	1100
INOX > 800 N/mm²	v_c [m/min]	60	60	60	60	60	60	60	60	60	60	60	60
	f_z [mm]	0,017	0,020	0,023	0,028	0,038	0,048	0,060	0,074	0,087	0,100	0,120	0,140
	v_f [mm/min]	430	390	360	360	370	370	390	410	420	440	480	450
	n [1/min]	6400	4800	3800	3200	2400	1900	1600	1400	1200	1100	1000	800
GG	v_c [m/min]	140	140	140	140	140	140	140	140	140	140	140	140
	f_z [mm]	0,028	0,033	0,039	0,046	0,063	0,079	0,099	0,121	0,140	0,165	0,200	0,230
	v_f [mm/min]	1640	1470	1370	1370	1400	1430	1470	1550	1570	1650	1760	1660
	n [1/min]	14900	11100	8900	7400	5600	4500	3700	3200	2800	2500	2200	1800
GGG	v_c [m/min]	130	130	130	130	130	130	130	130	130	130	130	130
	f_z [mm]	0,025	0,030	0,035	0,042	0,057	0,072	0,090	0,110	0,130	0,150	0,180	0,210
	v_f [mm/min]	1380	1240	1160	1160	1190	1180	1220	1320	1350	1380	1510	1430
	n [1/min]	13800	10300	8300	6900	5200	4100	3400	3000	2600	2300	2100	1700
hochwärmfeste Legierungen	v_c [m/min]	50	50	50	50	50	50	50	50	50	50	50	50
	f_z [mm]	0,016	0,020	0,023	0,027	0,037	0,047	0,059	0,072	0,085	0,098	0,117	0,137
	v_f [mm/min]	340	310	290	290	300	300	300	310	340	350	370	330
	n [1/min]	5300	4000	3200	2700	2000	1600	1300	1100	1000	900	800	600
Titan	v_c [m/min]	70	70	70	70	70	70	70	70	70	70	70	70
	f_z [mm]	0,017	0,020	0,023	0,028	0,038	0,048	0,060	0,074	0,087	0,100	0,120	0,140
	v_f [mm/min]	500	450	420	420	430	420	460	470	490	480	530	500
	n [1/min]	7400	5600	4500	3700	2800	2200	1900	1600	1400	1200	1100	900
NE-Metalle Cu-Legierungen	v_c [m/min]	210	210	210	210	210	210	210	210	210	210	210	210
	f_z [mm]	0,048	0,054	0,066	0,078	0,102	0,126	0,150	0,174	0,192	0,216	0,240	0,270
	v_f [mm/min]	4280	3610	3540	3460	3430	3380	3360	3340	3230	3200	3170	2920
	n [1/min]	22300	16700	13400	11100	8400	6700	5600	4800	4200	3700	3300	2700

	a_p	1,5 x D	1,5 x D
	a_e	0,3 x D	0,04 x D
	v_c	x 0,9	x 1
	f_z	x 0,7	x 1

	a_p	1 x D
	a_e	1 x D
	v_c	x 0,8
	f_z	x 0,5

HAM 40-5110

Vollhartmetall-Schaftfräser
solid carbide end mill

W+F VHM Z 4-6 40° rechts Werk Norm
Typ N DIN 6535 HA
HSF SHRINK FIT
DIN 6535 HB

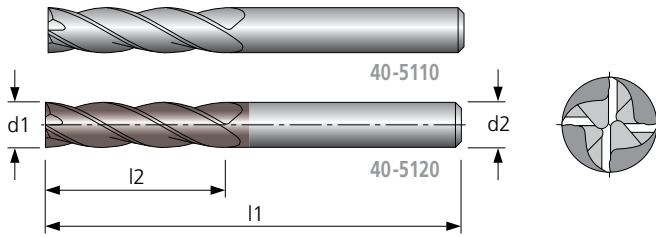

Material	Alu Knet-leg.	Alu Guss-leg.	Stahl < 800 N/mm²	Stahl < 1200 N/mm²	Stahl < 1600 N/mm²	Stahl < 55 HRC	Stahl < 60 HRC	Stahl < 66 HRC	INOX < 800 N/mm²	INOX > 800 N/mm²	GG	GGG	hochw. Legierungen	Titan	NE-Metalle Cu-Leg.	Graphit & Faser-verbund	MMS	max.	ohne	AIR
40-5110 / 40-5130	○	○	●	○	○				○	○	●	○	○	○	○		●	●	○	○
40-5120 / 40-5140	○	○	●	●	●	○			○	○	●	●	○	○	○		●	●	○	○

● sehr gut geeignet / very suitable ○ bedingt geeignet / limited suitable

HAM 40-5110* / 40-5120 / 40-5130* / 40-5140

* unbeschichtete Werkzeuge HAM 40-5110 / 40-5130: $v_c \times 0,5$ (ca.)
* uncoated tools HAM 40-5110 / 40-5130: $v_c \times 0,5$ (ca.)

Werkstoffgruppe material group	Ø mm	6	8	10	12	14	16	18	20	25	32
Alu Knetlegierungen	v_c [m/min]	300	300	300	300	300	300	300	300	300	300
	f_z [mm]	0,040	0,053	0,068	0,075	0,090	0,105	0,150	0,180	0,180	0,180
	v_f [mm/min]	2540	2500	2570	2400	2450	2520	3180	3460	4100	3240
	n [1/min]	15900	11900	9500	8000	6800	6000	5300	4800	3800	3000
Alu Gusslegierungen	v_c [m/min]	240	240	240	240	240	240	240	240	240	240
	f_z [mm]	0,006	0,008	0,010	0,011	0,014	0,016	0,023	0,027	0,027	0,027
	v_f [mm/min]	300	300	310	290	300	300	380	410	500	390
	n [1/min]	12700	9500	7600	6400	5500	4800	4200	3800	3100	2400
Stahl < 800 N/mm²	v_c [m/min]	120	120	120	120	120	120	120	120	120	120
	f_z [mm]	0,030	0,040	0,050	0,055	0,060	0,070	0,110	0,130	0,130	0,130
	v_f [mm/min]	770	770	750	700	650	670	920	990	1170	940
	n [1/min]	6400	4800	3800	3200	2700	2400	2100	1900	1500	1200
Stahl < 1200 N/mm²	v_c [m/min]	100	100	100	100	100	100	100	100	100	100
	f_z [mm]	0,025	0,035	0,045	0,050	0,060	0,070	0,100	0,120	0,120	0,120
	v_f [mm/min]	530	560	580	540	550	560	720	770	940	720
	n [1/min]	5300	4000	3200	2700	2300	2000	1800	1600	1300	1000
Stahl < 1600 N/mm²	v_c [m/min]	80	80	80	80	80	80	80	80	80	80
	f_z [mm]	0,020	0,030	0,038	0,043	0,051	0,060	0,085	0,102	0,102	0,102
	v_f [mm/min]	340	380	380	360	370	380	480	530	610	490
	n [1/min]	4200	3200	2500	2100	1800	1600	1400	1300	1000	800
Stahl < 55 HRC	v_c [m/min]	60	60	60	60	60	60	60	60	60	60
	f_z [mm]	0,038	0,021	0,027	0,030	0,036	0,042	0,060	0,072	0,072	0,072
	v_f [mm/min]	480	200	210	190	200	200	260	290	350	260
	n [1/min]	3200	2400	1900	1600	1400	1200	1100	1000	800	600
INOX < 800 N/mm²	v_c [m/min]	70	70	70	70	70	70	70	70	70	70
	f_z [mm]	0,018	0,023	0,029	0,033	0,039	0,046	0,065	0,078	0,078	0,078
	v_f [mm/min]	270	250	260	250	250	250	310	340	420	330
	n [1/min]	3700	2800	2200	1900	1600	1400	1200	1100	900	700
INOX > 800 N/mm²	v_c [m/min]	50	50	50	50	50	50	50	50	50	50
	f_z [mm]	0,012	0,016	0,020	0,023	0,027	0,032	0,045	0,054	0,054	0,054
	v_f [mm/min]	130	130	130	120	120	130	160	170	190	160
	n [1/min]	2700	2000	1600	1300	1100	1000	900	800	600	500
GG	v_c [m/min]	120	120	120	120	120	120	120	120	120	120
	f_z [mm]	0,025	0,039	0,050	0,055	0,066	0,077	0,110	0,132	0,132	0,132
	v_f [mm/min]	640	740	750	700	710	740	920	1000	1190	950
	n [1/min]	6400	4800	3800	3200	2700	2400	2100	1900	1500	1200
GGG	v_c [m/min]	100	100	100	100	100	100	100	100	100	100
	f_z [mm]	0,025	0,035	0,045	0,050	0,060	0,070	0,100	0,120	0,120	0,120
	v_f [mm/min]	530	560	580	540	550	560	720	770	940	720
	n [1/min]	5300	4000	3200	2700	2300	2000	1800	1600	1300	1000
hochwarmfeste Legierungen	v_c [m/min]	30	30	30	30	30	30	30	30	30	30
	f_z [mm]	0,020	0,023	0,029	0,033	0,039	0,046	0,065	0,078	0,078	0,078
	v_f [mm/min]	130	110	120	100	110	110	130	160	190	140
	n [1/min]	1600	1200	1000	800	700	600	500	500	400	300
Titan	v_c [m/min]	55	55	55	55	55	55	55	55	55	55
	f_z [mm]	0,017	0,023	0,030	0,034	0,040	0,047	0,067	0,080	0,080	0,080
	v_f [mm/min]	190	210	220	200	210	210	270	290	340	240
	n [1/min]	2900	2200	1800	1500	1300	1100	1000	900	700	500
NE-Metalle Cu-Legierungen	v_c [m/min]	180	180	180	180	180	180	180	180	180	180
	f_z [mm]	0,040	0,500	0,068	0,075	0,090	0,105	0,150	0,180	0,180	0,180
	v_f [mm/min]	1520	14400	1540	1440	1480	1510	1920	2090	2480	1940
	n [1/min]	9500	7200	5700	4800	4100	3600	3200	2900	2300	1800

	< 2 x D	< 3 x D	< 4,5 x D	< 6 x D	> 6 x D
a_p	2 x D	2 x D	2 x D	2 x D	2 x D
a_e	0,02 x D	0,02 x D	0,02 x D	0,02 x D	0,02 x D
v_c	x 1	x 0,5	x 0,3	x 0,2	x 0,15
f_z	x 1	x 0,9	x 0,75	x 0,65	x 0,55

HAM 40-5091 / 5191

Vollhartmetall-Schaftfräser
solid carbide end mill

W+F VHM Z 5 38° rechts 43° rechts Werk Norm
Typ N DIN 6535 HA
HSF HSC HPC SHRINK FIT
DIN 6535 HB

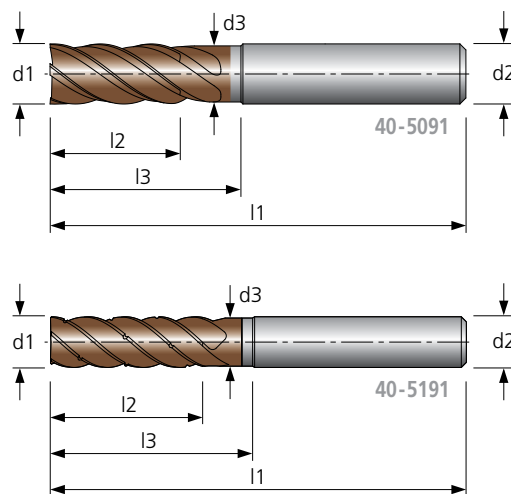

Material	Alu Knet-leg.	Alu Guss-leg.	Stahl < 800 N/mm²	Stahl < 1200 N/mm²	Stahl < 1600 N/mm²	Stahl < 55 HRC	Stahl < 60 HRC	Stahl < 66 HRC	INOX < 800 N/mm²	INOX > 800 N/mm²	GG	GGG	hochw. Legierungen	Titan	NE-Metalle Cu-Leg.	Graphit & Faser-verbund	MMS	max.	ohne	AIR
40-5091 / 40-5191			●	●	●				●	●	●	●	○	○			●	●	○	○

● sehr gut geeignet / very suitable ○ bedingt geeignet / limited suitable

HAM 40-5091 / 40-5191

Werkstoffgruppe material group	Ø mm	6	8	10	12	16	20
Stahl < 800 N/mm²	v _c [m/min] min.	260	260	260	260	260	260
	v _c [m/min] max.	380	380	380	380	380	380
	f _z [mm] min.	0,048	0,064	0,080	0,096	0,128	0,160
	f _z [mm] max.	0,090	0,120	0,150	0,180	0,240	0,300
	v _f [mm/min] min.	3310	3310	3310	3310	3310	3310
	v _f [mm/min] max.	9072	9072	9072	9072	9072	9072
	n [1/min] min.	13793	10345	8276	6897	5173	4138
	n [1/min] max.	20160	15120	12096	10080	7560	6048
	a _e [mm] min.	0,6	0,8	1	1,2	1,6	2
	a _e [mm] max.	0,9	1,2	1,5	1,8	2,4	3
	h _m [mm] min.	0,015	0,020	0,025	0,030	0,040	0,051
h _m [mm] max.	0,035	0,046	0,058	0,070	0,093	0,116	
Stahl < 1200 N/mm²	v _c [m/min] min.	210	210	210	210	210	210
	v _c [m/min] max.	300	300	300	300	300	300
	f _z [mm] min.	0,042	0,056	0,070	0,084	0,112	0,140
	f _z [mm] max.	0,084	0,112	0,140	0,168	0,224	0,280
	v _f [mm/min] min.	2340	2340	2340	2340	2340	2340
	v _f [mm/min] max.	6685	6685	6685	6685	6685	6685
	n [1/min] min.	11141	8356	6685	5570	4178	3342
	n [1/min] max.	15915	11937	9549	7958	5968	4775
	a _e [mm] min.	0,6	0,8	1	1,2	1,6	2
	a _e [mm] max.	0,9	1,2	1,5	1,8	2,4	3
	h _m [mm] min.	0,013	0,018	0,022	0,027	0,035	0,044
h _m [mm] max.	0,033	0,043	0,054	0,065	0,087	0,108	
Stahl < 1600 N/mm²	v _c [m/min] min.	160	160	160	160	160	160
	v _c [m/min] max.	220	220	220	220	220	220
	f _z [mm] min.	0,042	0,056	0,070	0,084	0,112	0,140
	f _z [mm] max.	0,084	0,112	0,140	0,168	0,224	0,280
	v _f [mm/min] min.	1783	1783	1783	1783	1783	1783
	v _f [mm/min] max.	4902	4902	4902	4902	4902	4902
	n [1/min] min.	8488	6366	5093	4244	3183	2546
	n [1/min] max.	11671	8754	7003	5836	4377	3501
	a _e [mm] min.	0,48	0,64	0,8	0,96	1,28	1,6
	a _e [mm] max.	0,72	0,96	1,2	1,44	1,92	2,4
	h _m [mm] min.	0,012	0,016	0,020	0,024	0,032	0,040
h _m [mm] max.	0,029	0,039	0,048	0,058	0,078	0,097	

a_p = max. Schneidlänge / max. cutting length

HAM 40-5091 / 40-5191								
Werkstoffgruppe material group	Ø mm	6	8	10	12	16	20	
INOX < 800 N/mm ²	v _c [m/min] min.	160	160	160	160	160	160	
	v _c [m/min] max.	220	220	220	220	220	220	
	f _z [mm] min.	0,042	0,056	0,070	0,084	0,112	0,140	
	f _z [mm] max.	0,066	0,088	0,110	0,132	0,176	0,220	
	v _f [mm/min] min.	1783	1783	1783	1783	1783	1783	
	v _f [mm/min] max.	3852	3852	3852	3852	3852	3852	
	n [1/min] min.	8488	6366	5093	4244	3183	2546	
	n [1/min] max.	11671	8754	7003	5836	4377	3501	
	a _e [mm] min.	0,6	0,8	1	1,2	1,6	2	
	a _e [mm] max.	0,9	1,2	1,5	1,8	2,4	3	
	h _m [mm] min.	0,013	0,018	0,022	0,027	0,035	0,044	
	h _m [mm] max.	0,026	0,034	0,043	0,051	0,068	0,085	
	INOX > 800 N/mm ²	v _c [m/min] min.	140	140	140	140	140	140
		v _c [m/min] max.	200	200	200	200	200	200
f _z [mm] min.		0,042	0,056	0,070	0,084	0,112	0,140	
f _z [mm] max.		0,066	0,088	0,110	0,132	0,176	0,220	
v _f [mm/min] min.		1560	1560	1560	1560	1560	1560	
v _f [mm/min] max.		3501	3501	3501	3501	3501	3501	
n [1/min] min.		7427	5570	4456	3714	2785	2228	
n [1/min] max.		10610	7958	6366	5305	3979	3183	
a _e [mm] min.		0,6	0,8	1	1,2	1,6	2	
a _e [mm] max.		0,9	1,2	1,5	1,8	2,4	3	
h _m [mm] min.		0,013	0,018	0,022	0,027	0,035	0,044	
h _m [mm] max.		0,026	0,034	0,043	0,051	0,068	0,085	
GG		v _c [m/min] min.	250	250	250	250	250	250
		v _c [m/min] max.	360	360	360	360	360	360
	f _z [mm] min.	0,048	0,064	0,080	0,096	0,128	0,160	
	f _z [mm] max.	0,090	0,120	0,150	0,180	0,240	0,300	
	v _f [mm/min] min.	3183	3183	3183	3183	3183	3183	
	v _f [mm/min] max.	8594	8594	8594	8594	8594	8594	
	n [1/min] min.	13263	9947	7958	6631	4974	3979	
	n [1/min] max.	19099	14324	11459	9549	7162	5730	
	a _e [mm] min.	0,6	0,8	1	1,2	1,6	2	
	a _e [mm] max.	0,9	1,2	1,5	1,8	2,4	3	
	h _m [mm] min.	0,015	0,020	0,025	0,030	0,040	0,051	
	h _m [mm] max.	0,035	0,046	0,058	0,070	0,093	0,116	
	GGG	v _c [m/min] min.	210	210	210	210	210	210
		v _c [m/min] max.	300	300	300	300	300	300
f _z [mm] min.		0,048	0,064	0,080	0,096	0,128	0,160	
f _z [mm] max.		0,090	0,120	0,150	0,180	0,240	0,300	
v _f [mm/min] min.		2674	2674	2674	2674	2674	2674	
v _f [mm/min] max.		7162	7162	7162	7162	7162	7162	
n [1/min] min.		11141	8356	6685	5570	4178	3342	
n [1/min] max.		15915	11937	9549	7958	5968	4775	
a _e [mm] min.		0,6	0,8	1	1,2	1,6	2	
a _e [mm] max.		0,9	1,2	1,5	1,8	2,4	3	
h _m [mm] min.		0,015	0,020	0,025	0,030	0,040	0,051	
h _m [mm] max.		0,035	0,046	0,058	0,070	0,093	0,116	
hochwärmfeste Legierungen		v _c [m/min] min.	40	40	40	40	40	40
		v _c [m/min] max.	90	90	90	90	90	90
	f _z [mm] min.	0,024	0,032	0,040	0,048	0,064	0,080	
	f _z [mm] max.	0,060	0,080	0,100	0,120	0,160	0,200	
	v _f [mm/min] min.	255	255	255	255	255	255	
	v _f [mm/min] max.	1432	1432	1432	1432	1432	1432	
	n [1/min] min.	2122	1592	1273	1061	796	637	
	n [1/min] max.	4775	3581	2865	2387	1790	1432	
	a _e [mm] min.	0,24	0,32	0,4	0,48	0,64	0,8	
	a _e [mm] max.	0,48	0,64	0,8	0,96	1,28	1,6	
	h _m [mm] min.	0,005	0,006	0,008	0,010	0,013	0,016	
	h _m [mm] max.	0,017	0,023	0,028	0,034	0,045	0,057	
	Titan	v _c [m/min] min.	80	80	80	80	80	80
		v _c [m/min] max.	130	130	130	130	130	130
f _z [mm] min.		0,036	0,048	0,060	0,072	0,096	0,120	
f _z [mm] max.		0,072	0,096	0,120	0,144	0,192	0,240	
v _f [mm/min] min.		764	764	764	764	764	764	
v _f [mm/min] max.		2483	2483	2483	2483	2483	2483	
n [1/min] min.		4244	3183	2546	2122	1592	1273	
n [1/min] max.		6897	5173	4138	3448	2586	2069	
a _e [mm] min.		0,6	0,8	1	1,2	1,6	2	
a _e [mm] max.		0,9	1,2	1,5	1,8	2,4	3	
h _m [mm] min.		0,011	0,015	0,019	0,023	0,030	0,038	
h _m [mm] max.		0,028	0,037	0,046	0,056	0,074	0,093	

ap = max. Schneidlänge / max. cutting length

HAM 40-5291

Vollhartmetall-Schaftfräser
solid carbide end mill

W+F VHM Z 5 38° rechts Werk Norm
Typ N DIN 6535 HB
HSF HSC HPC

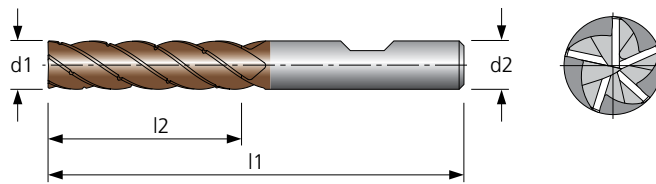

Material	Alu Knet-leg.	Alu Guss-leg.	Stahl < 800 N/mm²	Stahl < 1200 N/mm²	Stahl < 1600 N/mm²	Stahl < 55 HRC	Stahl < 60 HRC	Stahl < 66 HRC	INOX < 800 N/mm²	INOX > 800 N/mm²	GG	GGG	hochw. Legierungen	Titan	NE-Metalle Cu-Leg.	Graphit & Faser-verbund	MMS	max.	ohne	AIR
40-5291			●	●	●				●	●	●	●	○	○			●	●	○	○

● sehr gut geeignet / very suitable ○ bedingt geeignet / limited suitable

HAM 40-5291

Werkstoffgruppe material group	Ø mm	10	12	16	20
Stahl < 800 N/mm²	v _c [m/min] min.	240	240	240	240
	v _c [m/min] max.	310	310	310	310
	f _z [mm] min.	0,060	0,072	0,096	0,120
	f _z [mm] max.	0,110	0,132	0,176	0,220
	v _f [mm/min] min.	2292	2292	2292	2292
	v _f [mm/min] max.	5427	5427	5427	5427
	n [1/min] min.	7639	6366	4775	3820
	n [1/min] max.	9868	8223	6167	4934
	a _e [mm] min.	0,4	0,48	0,64	0,8
	a _e [mm] max.	0,6	0,72	0,96	1,2
Stahl < 1200 N/mm²	v _c [m/min] min.	200	200	200	200
	v _c [m/min] max.	270	270	270	270
	f _z [mm] min.	0,060	0,072	0,096	0,120
	f _z [mm] max.	0,110	0,132	0,176	0,220
	v _f [mm/min] min.	1910	1910	1910	1910
	v _f [mm/min] max.	4727	4727	4727	4727
	n [1/min] min.	6366	5305	3979	3183
	n [1/min] max.	8594	7162	5371	4297
	a _e [mm] min.	0,4	0,48	0,64	0,8
	a _e [mm] max.	0,6	0,72	0,96	1,2
Stahl < 1600 N/mm²	v _c [m/min] min.	150	150	150	150
	v _c [m/min] max.	210	210	210	210
	f _z [mm] min.	0,050	0,060	0,080	0,100
	f _z [mm] max.	0,100	0,120	0,160	0,200
	v _f [mm/min] min.	1194	1194	1194	1194
	v _f [mm/min] max.	3342	3342	3342	3342
	n [1/min] min.	4775	3979	2984	2387
	n [1/min] max.	6685	5570	4178	3342
	a _e [mm] min.	0,4	0,48	0,64	0,8
	a _e [mm] max.	0,6	0,72	0,96	1,2
h _m [mm] min.		0,010	0,012	0,016	0,020
	h _m [mm] max.	0,024	0,029	0,039	0,049

a_p = max. Schneidlänge / max. cutting length

HAM 40-5291					
Werkstoffgruppe material group	Ø mm	10	12	16	20
INOX < 800 N/mm ²	v _c [m/min] min.	110	110	110	110
	v _c [m/min] max.	170	170	170	170
	f _z [mm] min.	0,050	0,060	0,080	0,100
	f _z [mm] max.	0,100	0,120	0,160	0,200
	v _f [mm/min] min.	875	875	875	875
	v _f [mm/min] max.	2706	2706	2706	2706
	n [1/min] min.	3501	2918	2188	1751
	n [1/min] max.	5411	4509	3382	2706
	a _e [mm] min.	0,4	0,48	0,64	0,8
	a _e [mm] max.	0,6	0,72	0,96	1,2
	h _m [mm] min.	0,010	0,012	0,016	0,020
	h _m [mm] max.	0,024	0,029	0,039	0,049
INOX > 800 N/mm ²	v _c [m/min] min.	90	90	90	90
	v _c [m/min] max.	140	140	140	140
	f _z [mm] min.	0,040	0,048	0,064	0,080
	f _z [mm] max.	0,080	0,096	0,128	0,160
	v _f [mm/min] min.	573	573	573	573
	v _f [mm/min] max.	1783	1783	1783	1783
	n [1/min] min.	2865	2387	1790	1432
	n [1/min] max.	4456	3714	2785	2228
	a _e [mm] min.	0,4	0,48	0,64	0,8
	a _e [mm] max.	0,6	0,72	0,96	1,2
	h _m [mm] min.	0,008	0,010	0,013	0,016
	h _m [mm] max.	0,020	0,024	0,031	0,039
GG	v _c [m/min] min.	180	180	180	180
	v _c [m/min] max.	240	240	240	240
	f _z [mm] min.	0,060	0,072	0,096	0,120
	f _z [mm] max.	0,110	0,132	0,176	0,220
	v _f [mm/min] min.	1719	1719	1719	1719
	v _f [mm/min] max.	4202	4202	4202	4202
	n [1/min] min.	5730	4775	3581	2865
	n [1/min] max.	7639	6366	4775	3820
	a _e [mm] min.	0,4	0,48	0,64	0,8
	a _e [mm] max.	0,6	0,72	0,96	1,2
	h _m [mm] min.	0,012	0,014	0,019	0,024
	h _m [mm] max.	0,027	0,032	0,043	0,054
GGG	v _c [m/min] min.	160	160	160	160
	v _c [m/min] max.	210	210	210	210
	f _z [mm] min.	0,060	0,072	0,096	0,120
	f _z [mm] max.	0,110	0,132	0,176	0,220
	v _f [mm/min] min.	1528	1528	1528	1528
	v _f [mm/min] max.	3676	3676	3676	3676
	n [1/min] min.	5093	4244	3183	2546
	n [1/min] max.	6685	5570	4178	3342
	a _e [mm] min.	0,4	0,48	0,64	0,8
	a _e [mm] max.	0,6	0,72	0,96	1,2
	h _m [mm] min.	0,012	0,014	0,019	0,024
	h _m [mm] max.	0,027	0,032	0,043	0,054
hochwärmfeste Legierungen	v _c [m/min] min.	30	30	30	30
	v _c [m/min] max.	70	70	70	70
	f _z [mm] min.	0,040	0,048	0,064	0,080
	f _z [mm] max.	0,080	0,096	0,128	0,160
	v _f [mm/min] min.	191	191	191	191
	v _f [mm/min] max.	891	891	891	891
	n [1/min] min.	955	796	597	477
	n [1/min] max.	2228	1857	1393	1114
	a _e [mm] min.	0,4	0,48	0,64	0,8
	a _e [mm] max.	0,6	0,72	0,96	1,2
	h _m [mm] min.	0,008	0,010	0,013	0,016
	h _m [mm] max.	0,020	0,024	0,031	0,039
Titan	v _c [m/min] min.	70	70	70	70
	v _c [m/min] max.	110	110	110	110
	f _z [mm] min.	0,060	0,072	0,096	0,120
	f _z [mm] max.	0,100	0,120	0,160	0,200
	v _f [mm/min] min.	668	668	668	668
	v _f [mm/min] max.	1751	1751	1751	1751
	n [1/min] min.	2228	1857	1393	1114
	n [1/min] max.	3501	2918	2188	1751
	a _e [mm] min.	0,4	0,48	0,64	0,8
	a _e [mm] max.	0,6	0,72	0,96	1,2
	h _m [mm] min.	0,012	0,014	0,019	0,024
	h _m [mm] max.	0,024	0,029	0,039	0,049

ap = max. Schneidlänge / max. cutting length

HAM 40-1561

Vollhartmetall-Schaftfräser
solid carbide end mill

VHM Z 6-8 45° rechts Werk Norm
 Typ N DIN 6535 HA
 HSF HSC SHRINK FIT
 DIN 6535 HB

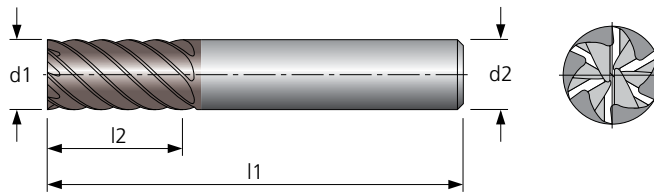

Material	Alu Knetleg.	Alu Gussleg.	Stahl < 800 N/mm²	Stahl < 1200 N/mm²	Stahl < 1600 N/mm²	Stahl < 55 HRC	Stahl < 60 HRC	Stahl < 66 HRC	INOX < 800 N/mm²	INOX > 800 N/mm²	GG	GGG	hochw. Legierungen	Titan	NE-Metalle Cu-Leg.	Graphit & Faserbund.	MMS	max.	ohne	AIR
40-1561	○	○	●	●	●	○			●	●	●	●	●	●	○		●	●	○	○

● sehr gut geeignet / very suitable ○ bedingt geeignet / limited suitable

HAM 40-1561

Werkstoffgruppe material group	Ø mm	6	8	10	12	14	16	18	20	25	32
Alu Knetlegierungen	v _c [m/min]	600	600	600	600	600	600	600	600	600	600
	f _z [mm]	0,053	0,068	0,090	0,105	0,120	0,135	0,150	0,180	0,225	0,300
	v _f [mm/min]	10020	9680	10310	10020	9790	9640	12720	13680	13680	14400
	n [1/min]	31800	23900	19100	15900	13600	11900	10600	9500	7600	6000
Alu Gusslegierungen	v _c [m/min]	480	480	480	480	480	480	480	480	480	480
	f _z [mm]	0,042	0,054	0,072	0,084	0,096	0,108	0,120	0,144	0,180	0,240
	v _f [mm/min]	6430	6190	6610	6400	6280	6160	8160	8760	8760	9220
	n [1/min]	25500	19100	15300	12700	10900	9500	8500	7600	6100	4800
Stahl < 800 N/mm²	v _c [m/min]	240	240	240	240	240	240	240	240	240	240
	f _z [mm]	0,042	0,054	0,072	0,084	0,096	0,108	0,120	0,144	0,180	0,240
	v _f [mm/min]	3200	3080	3280	3230	3170	3110	4030	4380	4460	4610
	n [1/min]	12700	9500	7600	6400	5500	4800	4200	3800	3100	2400
Stahl < 1200 N/mm²	v _c [m/min]	200	200	200	200	200	200	200	200	200	200
	f _z [mm]	0,035	0,045	0,060	0,070	0,080	0,090	0,100	0,120	0,150	0,200
	v _f [mm/min]	2230	2160	2300	2230	2160	2160	2800	3070	3000	3200
	n [1/min]	10600	8000	6400	5300	4500	4000	3500	3200	2500	2000
Stahl < 1600 N/mm²	v _c [m/min]	170	170	170	170	170	170	170	170	170	170
	f _z [mm]	0,030	0,038	0,051	0,060	0,068	0,077	0,085	0,102	0,128	0,170
	v _f [mm/min]	1610	1560	1650	1610	1590	1560	2040	2200	2240	2310
	n [1/min]	9000	6800	5400	4500	3900	3400	3000	2700	2200	1700
Stahl < 55 HRC	v _c [m/min]	120	120	120	120	120	120	120	120	120	120
	f _z [mm]	0,023	0,030	0,040	0,047	0,054	0,060	0,067	0,080	0,101	0,134
	v _f [mm/min]	900	870	920	900	870	870	1130	1220	1210	1290
	n [1/min]	6400	4800	3800	3200	2700	2400	2100	1900	1500	1200
INOX < 800 N/mm²	v _c [m/min]	130	130	130	130	130	130	130	130	130	130
	f _z [mm]	0,028	0,036	0,048	0,056	0,064	0,072	0,080	0,096	0,120	0,160
	v _f [mm/min]	1160	1120	1180	1140	1150	1120	1470	1610	1630	1660
	n [1/min]	6900	5200	4100	3400	3000	2600	2300	2100	1700	1300
INOX > 800 N/mm²	v _c [m/min]	90	90	90	90	90	90	90	90	90	90
	f _z [mm]	0,023	0,030	0,040	0,047	0,054	0,060	0,067	0,080	0,101	0,134
	v _f [mm/min]	680	650	700	680	640	650	860	900	880	960
	n [1/min]	4800	3600	2900	2400	2000	1800	1600	1400	1100	900
GG	v _c [m/min]	230	230	230	230	230	230	230	230	230	230
	f _z [mm]	0,042	0,054	0,072	0,084	0,096	0,108	0,120	0,144	0,180	0,240
	v _f [mm/min]	3070	2980	3150	3070	3000	2980	3940	4260	4180	4420
	n [1/min]	12200	9200	7300	6100	5200	4600	4100	3700	2900	2300
GGG	v _c [m/min]	200	200	200	200	200	200	200	200	200	200
	f _z [mm]	0,035	0,045	0,060	0,070	0,080	0,090	0,100	0,120	0,150	0,200
	v _f [mm/min]	2230	2160	2300	2230	2160	2160	2800	3070	3000	3200
	n [1/min]	10600	8000	6400	5300	4500	4000	3500	3200	2500	2000
hochwarmfeste Legierungen	v _c [m/min]	60	60	60	60	60	60	60	60	60	60
	f _z [mm]	0,023	0,029	0,039	0,046	0,052	0,059	0,065	0,078	0,098	0,130
	v _f [mm/min]	440	420	440	440	440	420	570	620	620	620
	n [1/min]	3200	2400	1900	1600	1400	1200	1100	1000	800	600
Titan	v _c [m/min]	110	110	110	110	110	110	110	110	110	110
	f _z [mm]	0,023	0,030	0,040	0,047	0,054	0,060	0,067	0,080	0,101	0,134
	v _f [mm/min]	820	800	840	820	800	800	1020	1160	1130	1180
	n [1/min]	5800	4400	3500	2900	2500	2200	1900	1800	1400	1100
NE-Metalle Cu-Legierungen	v _c [m/min]	360	360	360	360	360	360	360	360	360	360
	f _z [mm]	0,053	0,068	0,090	0,105	0,120	0,135	0,150	0,180	0,225	0,300
	v _f [mm/min]	6020	5790	6210	5990	5900	5830	7680	8210	8280	8640
	n [1/min]	19100	14300	11500	9500	8200	7200	6400	5700	4600	3600

		< 2 x D	< 3 x D	< 4,5 x D	< 6 x D	> 6 x D
	a _p	1,5 x D	1,5 x D	1,5 x D	1,5 x D	1,5 x D
	a _e	0,02 x D	0,02 x D	0,02 x D	0,02 x D	0,02 x D
	v _c	x 1	x 0,5	x 0,3	x 0,2	x 0,15
	f _z	x 1	x 0,9	x 0,75	x 0,65	x 0,55

HAM 40-1571

**Vollhartmetall-Schaftfräser
solid carbide end mill**

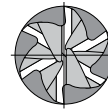
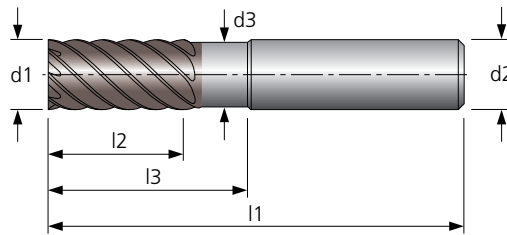

VHM **Z 6-8** **34°/35°/36°re** **Werk Norm**

Typ N **DIN 6535 HA**

HSF **HSC** **SHRINK FIT**

DIN 6535 HB

Material	Alu Knet-leg.	Alu Guss-leg.	Stahl < 800 N/mm²	Stahl < 1200 N/mm²	Stahl < 1600 N/mm²	Stahl < 55 HRC	Stahl < 60 HRC	Stahl < 66 HRC	INOX < 800 N/mm²	INOX > 800 N/mm²	GG	GGG	hochw. Legierungen	Titan	NE-Metalle Cu-Leg.	Graphit & Faser-verbund	MMS	max.	ohne	AIR
40-1571	○	○	●	●	●	○			●	●	●	●	●	●	○		●	●	○	○

● sehr gut geeignet / very suitable ○ bedingt geeignet / limited suitable

HAM 40-1571

Werkstoffgruppe material group	Ø mm	6	8	10	12	16	20	25	32
Alu Knetlegierungen	v _c [m/min]	800	800	800	800	800	800	800	800
	f _z [mm]	0,055	0,070	0,090	0,105	0,135	0,180	0,225	0,300
	v _f [mm/min]	13990	13360	13770	13360	12880	18290	18360	19200
	n [1/min]	42400	31800	25500	21200	15900	12700	10200	8000
Alu Gusslegierungen	v _c [m/min]	600	600	600	600	600	600	600	600
	f _z [mm]	0,045	0,060	0,080	0,090	0,115	0,150	0,190	0,255
	v _f [mm/min]	8590	8600	9170	8590	8210	11400	11550	12240
	n [1/min]	31800	23900	19100	15900	11900	9500	7600	6000
Stahl < 800 N/mm²	v _c [m/min]	350	350	350	350	350	350	350	350
	f _z [mm]	0,040	0,050	0,070	0,080	0,100	0,130	0,165	0,220
	v _f [mm/min]	4460	4170	4660	4460	4200	5820	5940	6160
	n [1/min]	18600	13900	11100	9300	7000	5600	4500	3500
Stahl < 1200 N/mm²	v _c [m/min]	300	300	300	300	300	300	300	300
	f _z [mm]	0,035	0,045	0,060	0,070	0,090	0,120	0,150	0,200
	v _f [mm/min]	3340	3210	3420	3360	3240	4610	4560	4800
	n [1/min]	15900	11900	9500	8000	6000	4800	3800	3000
Stahl < 1600 N/mm²	v _c [m/min]	280	280	280	280	280	280	280	280
	f _z [mm]	0,030	0,040	0,050	0,060	0,070	0,080	0,085	0,100
	v _f [mm/min]	2680	2660	2670	2660	2350	2880	2450	2240
	n [1/min]	14900	11100	8900	7400	5600	4500	3600	2800
Stahl < 55 HRC	v _c [m/min]	150	150	150	150	150	150	150	150
	f _z [mm]	0,025	0,030	0,040	0,050	0,060	0,080	0,100	0,135
	v _f [mm/min]	1200	1080	1150	1200	1080	1540	1520	1620
	n [1/min]	8000	6000	4800	4000	3000	2400	1900	1500
INOX < 800 N/mm²	v _c [m/min]	150	150	150	150	150	150	150	150
	f _z [mm]	0,030	0,040	0,050	0,060	0,070	0,100	0,120	0,160
	v _f [mm/min]	1440	1440	1440	1440	1260	1920	1820	1920
	n [1/min]	8000	6000	4800	4000	3000	2400	1900	1500
INOX > 800 N/mm²	v _c [m/min]	140	140	140	140	140	140	140	140
	f _z [mm]	0,016	0,020	0,030	0,035	0,040	0,055	0,070	0,090
	v _f [mm/min]	710	670	810	780	670	970	1010	1010
	n [1/min]	7400	5600	4500	3700	2800	2200	1800	1400
GG	v _c [m/min]	260	260	260	260	260	260	260	260
	f _z [mm]	0,040	0,050	0,070	0,080	0,100	0,130	0,165	0,220
	v _f [mm/min]	3310	3090	3490	3310	3120	4260	4360	4580
	n [1/min]	13800	10300	8300	6900	5200	4100	3300	2600
GGG	v _c [m/min]	230	230	230	230	230	230	230	230
	f _z [mm]	0,035	0,045	0,060	0,070	0,090	0,120	0,150	0,200
	v _f [mm/min]	2560	2480	2630	2560	2480	3550	3480	3680
	n [1/min]	12200	9200	7300	6100	4600	3700	2900	2300
hochwärmfeste Legierungen	v _c [m/min]	100	100	100	100	100	100	100	100
	f _z [mm]	0,025	0,030	0,040	0,050	0,060	0,080	0,100	0,130
	v _f [mm/min]	800	720	770	810	720	1020	1040	1040
	n [1/min]	5300	4000	3200	2700	2000	1600	1300	1000
Titan	v _c [m/min]	150	150	150	150	150	150	150	150
	f _z [mm]	0,025	0,030	0,040	0,050	0,060	0,080	0,100	0,135
	v _f [mm/min]	1200	1080	1150	1200	1080	1540	1520	1620
	n [1/min]	8000	6000	4800	4000	3000	2400	1900	1500
NE-Metalle Cu-Legierungen	v _c [m/min]	450	450	450	450	450	450	450	450
	f _z [mm]	0,050	0,070	0,090	0,105	0,135	0,180	0,225	0,300
	v _f [mm/min]	7170	7520	7720	7500	7290	10370	10260	10800
	n [1/min]	23900	17900	14300	11900	9000	7200	5700	4500

	< 2 x D	< 3 x D	< 4,5 x D	< 6 x D	> 6 x D
ap	1,5 x D	1,5 x D	1,5 x D	1,5 x D	1,5 x D
ae	0,02 x D	0,02 x D	0,02 x D	0,02 x D	0,02 x D
v _c	x 1	x 0,5	x 0,3	x 0,2	x 0,15
f _z	x 1	x 0,9	x 0,75	x 0,65	x 0,55

HAM 40-5200 / 5240

Vollhartmetall-Schaftfräser
solid carbide end mill

W+F VHM Z 4-8 Z 6-8 45° rechts Werk Norm
Typ H DIN 6535 HA
HSC SHRINK FIT
DIN 6535 HB

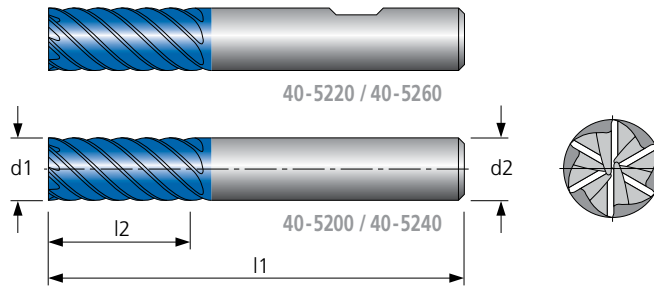

Material	Alu Knet-leg.	Alu Guss-leg.	Stahl < 800 N/mm²	Stahl < 1200 N/mm²	Stahl < 1600 N/mm²	Stahl < 55 HRC	Stahl < 60 HRC	Stahl < 66 HRC	INOX < 800 N/mm²	INOX > 800 N/mm²	GG	GGG	hochw. Legierungen	Titan	NE-Metalle Cu-Leg.	Graphit & Faser-verbund	MMS	max.	ohne	AIR
40-5200 / 40-5220																				
40-5240 / 40-5260						●	●	●									●		●	●

● sehr gut geeignet / very suitable ○ bedingt geeignet / limited suitable

HAM 40-5200 / 40-5220 / 40-5240 / 40-5260

Werkstoffgruppe material group	Ø mm	3	4	5	6	8	10	12	14	16	18	20	25	32
Stahl < 55 HRC	v _c [m/min]	200	200	200	200	200	200	200	200	200	200	200	200	200
	f _z [mm]	0,025	0,030	0,040	0,050	0,065	0,080	0,095	0,110	0,120	0,140	0,160	0,200	0,250
	v _f [mm/min]	2120	2860	3050	3180	3120	3070	3020	2970	2880	3920	4100	4000	4000
	n [1/min]	21200	15900	12700	10600	8000	6400	5300	4500	4000	3500	3200	2500	2000
Stahl < 60 HRC	v _c [m/min]	180	180	180	180	180	180	180	180	180	180	180	180	180
	f _z [mm]	0,025	0,030	0,040	0,050	0,065	0,080	0,100	0,110	0,130	0,140	0,160	0,200	0,250
	v _f [mm/min]	1910	2570	2760	2850	2810	2740	2880	2710	2810	3580	3710	3680	3600
	n [1/min]	19100	14300	11500	9500	7200	5700	4800	4100	3600	3200	2900	2300	1800
Stahl < 66 HRC	v _c [m/min]	100	100	100	100	100	100	100	100	100	100	100	100	100
	f _z [mm]	0,020	0,030	0,035	0,040	0,060	0,075	0,085	0,090	0,100	0,120	0,120	0,150	0,110
	v _f [mm/min]	850	1440	1340	1270	1440	1440	1380	1240	1200	1730	1540	1560	880
	n [1/min]	10600	8000	6400	5300	4000	3200	2700	2300	2000	1800	1600	1300	1000

			Stahl < 55 HRC	Stahl < 60 HRC	Stahl < 66 HRC
	< 2 x D	a _p	1,5 x D	1,5 x D	1,5 x D
		a _e	0,05 x D	0,03 x D	0,02 x D
		v _c	x 1	x 1	x 1
		f _z	x 1	x 1	x 1
		n	x 1	x 1	x 1
	> 2 x D	a _p	1,5 x D	1,5 x D	1,5 x D
		a _e	0,05 x D	0,03 x D	0,02 x D
		v _c	x 0,8	x 0,8	x 0,8
		f _z	x 0,8	x 0,8	x 0,8
		n	x 0,8	x 0,8	x 0,8

HAM 40-5280 / 5320

Vollhartmetall-Schaftfräser
solid carbide end mill

W+F VHM Z 6-8 45° rechts Werk Norm
Typ H DIN 6535 HA
Eckradius HSC SHRINK FIT
DIN 6535 HB

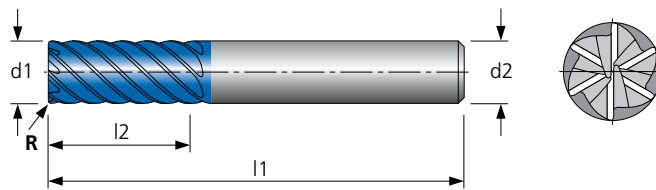

Material	Alu Knet-leg.	Alu Guss-leg.	Stahl < 800 N/mm²	Stahl < 1200 N/mm²	Stahl < 1600 N/mm²	Stahl < 55 HRC	Stahl < 60 HRC	Stahl < 66 HRC	INOX < 800 N/mm²	INOX > 800 N/mm²	GG	GGG	hochw. Legierungen	Titan	NE-Metalle Cu-Leg.	Graphit & Faser-verbund	MMS	max.	ohne	AIR
40-5280 / 40-5320						●	●	●									●		●	●

● sehr gut geeignet / very suitable ○ bedingt geeignet / limited suitable

HAM 40-5280 / 40-5320

Werkstoffgruppe material group	Ø mm	6	8	10	12	14	16	18	20	25
Stahl < 55 HRC	v _c [m/min]	200	200	200	200	200	200	200	200	200
	f _z [mm]	0,050	0,065	0,080	0,095	0,110	0,120	0,140	0,160	0,180
	v _f [mm/min]	3180	3120	3070	3020	2970	2880	3920	4100	3600
	n [1/min]	10600	8000	6400	5300	4500	4000	3500	3200	2500
Stahl < 60 HRC	v _c [m/min]	180	180	180	180	180	180	180	180	180
	f _z [mm]	0,050	0,065	0,080	0,100	0,110	0,120	0,140	0,160	0,180
	v _f [mm/min]	2850	2810	2740	2880	2710	2590	3580	3710	3310
	n [1/min]	9500	7200	5700	4800	4100	3600	3200	2900	2300
Stahl < 66 HRC	v _c [m/min]	100	100	100	100	100	100	100	100	100
	f _z [mm]	0,040	0,060	0,075	0,085	0,090	0,100	0,120	0,120	0,120
	v _f [mm/min]	1270	1440	1440	1380	1240	1200	1730	1540	1250
	n [1/min]	5300	4000	3200	2700	2300	2000	1800	1600	1300

			Stahl < 55 HRC	Stahl < 60 HRC	Stahl < 66 HRC
	< 2 x D	a _p	1,5 x D	1,5 x D	1,5 x D
		a _e	0,05 x D	0,03 x D	0,02 x D
		v _c	x 1	x 1	x 1
		f _z	x 1	x 1	x 1
		f _z	x 1	x 1	x 1
	> 2 x D	a _p	1,5 x D	1,5 x D	1,5 x D
		a _e	0,05 x D	0,03 x D	0,02 x D
		v _c	x 0,8	x 0,8	x 0,8
		f _z	x 0,8	x 0,8	x 0,8
		f _z	x 0,8	x 0,8	x 0,8

HAM 40-5350

**Vollhartmetall-Schruppfräser
solid carbide roughing end mill**

VHM Z 3 45° rechts Werk Norm
 Typ W DIN 6535 HA
 HSF HSC HPC SHRINK FIT
 DIN 6535 HB

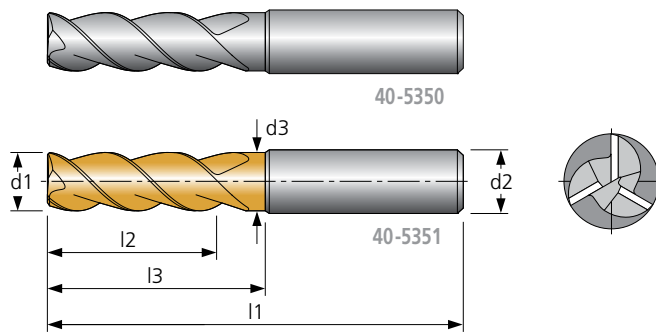

Material	Alu Knet-leg.	Alu Guss-leg.	Stahl < 800 N/mm ²	Stahl < 1200 N/mm ²	Stahl < 1600 N/mm ²	Stahl < 55 HRC	Stahl < 60 HRC	Stahl < 66 HRC	INOX < 800 N/mm ²	INOX > 800 N/mm ²	GG	GGG	hochw. Legierungen	Titan	NE-Metalle Cu-Leg.	Graphit & Faser-verbund	MMS	max.	ohne	AIR
40-5350 / 40-5351	●	●													●		○	●	○	○

● sehr gut geeignet / very suitable ○ bedingt geeignet / limited suitable

HAM 40-5350* / 40-5351

* unbeschichtete Werkzeuge HAM 40-5350: $v_c \times 0,5$ (ca.)
 * uncoated tools HAM 40-5350: $v_c \times 0,5$ (ca.)

Werkstoffgruppe material group	Ø mm	Umfangfräsen periphery milling								
		3	4	5	6	8	10	12	16	20
Alu Knetlegierungen	v_c [m/min]	180	250	300	350	400	400	400	400	400
	f_z [mm]	0,040	0,045	0,050	0,060	0,070	0,130	0,180	0,250	0,310
	v_f [mm/min]	2290	2690	2870	3350	3340	4950	5720	6000	5950
	n [1/min]	19100	19900	19100	18600	15900	12700	10600	8000	6400
Alu Gusslegierungen	v_c [m/min]	180	250	300	350	400	400	400	400	400
	f_z [mm]	0,040	0,045	0,050	0,060	0,070	0,130	0,180	0,250	0,310
	v_f [mm/min]	2290	2690	2870	3350	3340	4950	5720	6000	5950
	n [1/min]	19100	19900	19100	18600	15900	12700	10600	8000	6400
NE-Metalle Cu-Legierungen	v_c [m/min]	180	250	300	350	400	400	400	400	400
	f_z [mm]	0,050	0,060	0,080	0,090	0,120	0,150	0,210	0,270	0,330
	v_f [mm/min]	2870	3580	4580	5020	5720	5720	6680	6480	6340
	n [1/min]	19100	19900	19100	18600	15900	12700	10600	8000	6400

Werkstoffgruppe material group	Ø mm	Nutfräsen slot milling								
		3	4	5	6	8	10	12	16	20
Alu Knetlegierungen	v_c [m/min]	160	200	250	250	300	300	300	300	300
	f_z [mm]	0,035	0,040	0,045	0,050	0,070	0,120	0,170	0,240	0,300
	v_f [mm/min]	1790	1910	2150	2000	2500	3420	4080	4320	4320
	n [1/min]	17000	15900	15900	13300	11900	9500	8000	6000	4800
Alu Gusslegierungen	v_c [m/min]	160	200	250	250	300	300	300	300	300
	f_z [mm]	0,040	0,050	0,070	0,080	0,100	0,120	0,170	0,240	0,300
	v_f [mm/min]	2040	2390	3340	3190	3570	3420	4080	4320	4320
	n [1/min]	17000	15900	15900	13300	11900	9500	8000	6000	4800
NE-Metalle Cu-Legierungen	v_c [m/min]	160	200	200	200	200	200	200	200	200
	f_z [mm]	0,045	0,055	0,075	0,085	0,110	0,140	0,200	0,260	0,320
	v_f [mm/min]	2300	2620	2860	2700	2640	2690	3180	3120	3070
	n [1/min]	17000	15900	12700	10600	8000	6400	5300	4000	3200

		l3 = kurz/short	l3 = lang/long
	a_p	1 x D	1 x D
	a_e	0,3 x D	0,3 x D
	v_c	x 1	x 0,7
	f_z	x 1	x 0,85
	a_p	1 x D	1 x D
	a_e	1 x D	1 x D
	v_c	x 1	x 0,65
	f_z	x 1	x 0,7

HAM 40-1691

Vollhartmetall-Schruppfräser
solid carbide roughing end mill

VHM Z 4 20°/23° re Werk Norm
 Typ HR DIN 6535 HA
 HPC SHRINK FIT
 DIN 6535 HB

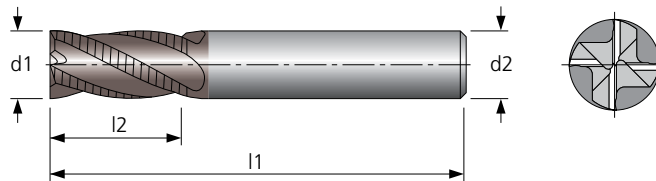

Material	Alu Knet-leg.	Alu Guss-leg.	Stahl < 800 N/mm²	Stahl < 1200 N/mm²	Stahl < 1600 N/mm²	Stahl < 55 HRC	Stahl < 60 HRC	Stahl < 66 HRC	INOX < 800 N/mm²	INOX > 800 N/mm²	GG	GGG	hochw. Legierungen	Titan	NE-Metalle Cu-Leg.	Graphit & Faser-verbund	MMS	max.	ohne	AIR
40-1691			●	●	●				○	○	●	●	○				●	●		

● sehr gut geeignet / very suitable ○ bedingt geeignet / limited suitable

HAM 40-1691

Werkstoffgruppe material group	Ø mm	6	8	10	12	14	16	20	25
Stahl < 800 N/mm²	v _c [m/min]	155	155	155	155	155	155	155	155
	f _z [mm]	0,045	0,060	0,075	0,100	0,120	0,140	0,200	0,280
	v _f [mm/min]	1110	1120	1470	1640	1680	1740	2000	3360
	n [1/min]	8200	6200	4900	4100	3500	3100	2500	2000
Stahl < 1200 N/mm²	v _c [m/min]	130	130	130	130	130	130	130	130
	f _z [mm]	0,040	0,055	0,070	0,090	0,110	0,130	0,180	0,250
	v _f [mm/min]	830	860	1150	1220	1320	1350	1510	2550
	n [1/min]	6900	5200	4100	3400	3000	2600	2100	1700
Stahl < 1600 N/mm²	v _c [m/min]	110	110	110	110	110	110	110	110
	f _z [mm]	0,034	0,047	0,060	0,077	0,094	0,111	0,150	0,200
	v _f [mm/min]	590	620	830	890	940	970	1080	1680
	n [1/min]	5800	4400	3500	2900	2500	2200	1800	1400
INOX < 800 N/mm²	v _c [m/min]	85	85	85	85	85	85	85	85
	f _z [mm]	0,032	0,044	0,056	0,072	0,090	0,100	0,140	0,200
	v _f [mm/min]	430	450	600	660	680	680	780	1320
	n [1/min]	4500	3400	2700	2300	1900	1700	1400	1100
INOX > 800 N/mm²	v _c [m/min]	60	60	60	60	60	60	60	60
	f _z [mm]	0,027	0,037	0,047	0,060	0,075	0,090	0,120	0,170
	v _f [mm/min]	260	270	360	390	420	430	480	820
	n [1/min]	3200	2400	1900	1600	1400	1200	1000	800
GG	v _c [m/min]	160	160	160	160	160	160	160	160
	f _z [mm]	0,045	0,060	0,075	0,100	0,120	0,140	0,200	0,280
	v _f [mm/min]	1150	1150	1530	1680	1730	1790	2000	3360
	n [1/min]	8500	6400	5100	4200	3600	3200	2500	2000
GGG	v _c [m/min]	140	140	140	140	140	140	140	140
	f _z [mm]	0,040	0,055	0,070	0,090	0,110	0,130	0,180	0,250
	v _f [mm/min]	890	920	1260	1330	1410	1460	1580	2700
	n [1/min]	7400	5600	4500	3700	3200	2800	2200	1800
hochwärmfeste Legierungen	v _c [m/min]	50	50	50	50	50	50	50	50
	f _z [mm]	0,026	0,036	0,046	0,059	0,072	0,085	0,120	0,160
	v _f [mm/min]	210	210	290	300	310	340	380	580
	n [1/min]	2700	2000	1600	1300	1100	1000	800	600

	a _p	1,5 x D
	a _e	0,5 x D
	v _c	x 0,9
	f _z	x 0,85
	a _p	1 x D
	a _e	1 x D
	v _c	x 0,85
	f _z	x 0,5

HAM 40-1681

Vollhartmetall-Schruppfräser
solid carbide roughing end mill

VHM Z 3-6 20° rechts Werk Norm
 Typ HR DIN 6535 HA
 HPC SHRINK FIT
 DIN 6535 HB

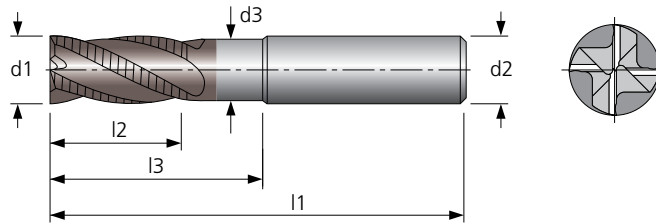

Material	Alu Knet-leg.	Alu Guss-leg.	Stahl < 800 N/mm²	Stahl < 1200 N/mm²	Stahl < 1600 N/mm²	Stahl < 55 HRC	Stahl < 60 HRC	Stahl < 66 HRC	INOX < 800 N/mm²	INOX > 800 N/mm²	GG	GGG	hochw. Legierungen	Titan	NE-Metalle Cu-Leg.	Graphit & Faser-verbund	MMS	max.	ohne	AIR
40-1681			●	●	●				○	○	●	●	○				●	●		

● sehr gut geeignet / very suitable ○ bedingt geeignet / limited suitable

HAM 40-1681

Werkstoffgruppe material group	Ø mm	4	5	6	7	8	9	10	12	14	16	18	20	25
Stahl < 800 N/mm²	V _c [m/min]	140	140	140	140	140	140	140	140	140	140	140	140	140
	f _z [mm]	0,035	0,040	0,045	0,050	0,055	0,060	0,065	0,070	0,080	0,090	0,100	0,110	0,130
	V _f [mm/min]	1170	1070	1000	960	920	900	1170	1040	1020	1010	1000	970	1400
	n [1/min]	11100	8900	7400	6400	5600	5000	4500	3700	3200	2800	2500	2200	1800
Stahl < 1200 N/mm²	V _c [m/min]	120	120	120	120	120	120	120	120	120	120	120	120	120
	f _z [mm]	0,030	0,035	0,040	0,045	0,050	0,055	0,060	0,065	0,070	0,080	0,090	0,100	0,120
	V _f [mm/min]	860	800	770	740	720	690	910	830	760	770	760	760	1080
	n [1/min]	9500	7600	6400	5500	4800	4200	3800	3200	2700	2400	2100	1900	1500
Stahl < 1600 N/mm²	V _c [m/min]	100	100	100	100	100	100	100	100	100	100	100	100	100
	f _z [mm]	0,025	0,030	0,035	0,040	0,045	0,050	0,055	0,060	0,065	0,070	0,080	0,090	0,100
	V _f [mm/min]	600	580	560	540	540	530	700	650	600	560	580	580	780
	n [1/min]	8000	6400	5300	4500	4000	3500	3200	2700	2300	2000	1800	1600	1300
INOX < 800 N/mm²	V _c [m/min]	80	80	80	80	80	80	80	80	80	80	80	80	80
	f _z [mm]	0,020	0,025	0,030	0,035	0,040	0,045	0,050	0,055	0,060	0,065	0,075	0,085	0,095
	V _f [mm/min]	380	380	380	380	380	380	500	460	430	420	420	440	570
	n [1/min]	6400	5100	4200	3600	3200	2800	2500	2100	1800	1600	1400	1300	1000
INOX > 800 N/mm²	V _c [m/min]	55	55	55	55	55	55	55	55	55	55	55	55	55
	f _z [mm]	0,020	0,023	0,027	0,030	0,034	0,037	0,040	0,044	0,047	0,054	0,060	0,067	0,080
	V _f [mm/min]	260	240	230	230	220	210	290	260	240	240	240	240	340
	n [1/min]	4400	3500	2900	2500	2200	1900	1800	1500	1300	1100	1000	900	700
GG	V _c [m/min]	140	140	140	140	140	140	140	140	140	140	140	140	140
	f _z [mm]	0,035	0,040	0,045	0,050	0,055	0,060	0,065	0,070	0,080	0,090	0,100	0,110	0,130
	V _f [mm/min]	1170	1070	1000	960	920	900	1170	1040	1020	1010	1000	970	1400
	n [1/min]	11100	8900	7400	6400	5600	5000	4500	3700	3200	2800	2500	2200	1800
GGG	V _c [m/min]	120	120	120	120	120	120	120	120	120	120	120	120	120
	f _z [mm]	0,030	0,035	0,040	0,045	0,050	0,055	0,060	0,065	0,070	0,080	0,090	0,100	0,120
	V _f [mm/min]	860	800	770	740	720	690	910	830	760	770	760	760	1080
	n [1/min]	9500	7600	6400	5500	4800	4200	3800	3200	2700	2400	2100	1900	1500
hochwärmfeste Legierungen	V _c [m/min]	50	50	50	50	50	50	50	50	50	50	50	50	50
	f _z [mm]	0,020	0,023	0,026	0,029	0,033	0,036	0,039	0,042	0,046	0,052	0,059	0,065	0,078
	V _f [mm/min]	240	220	210	200	200	190	250	220	200	210	210	210	280
	n [1/min]	4000	3200	2700	2300	2000	1800	1600	1300	1100	1000	900	800	600

	a _p	1,5 x D
	a _e	0,25 x D
	v _c	x 1
	f _z	x 1
	a _p	1 x D
	a _e	1 x D
	v _c	x 0,8
	f _z	x 0,6

HAM 40-1600

Vollhartmetall-Konturenfräser (upcut)
solid carbide router (upcut)

VHM Z 8-12 22°-25°re Werk Norm
Typ W HA
G-Point

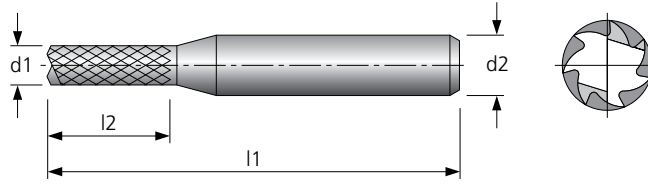

Material	Alu Knet-leg.	Alu Guss-leg.	Stahl < 800 N/mm²	Stahl < 1200 N/mm²	Stahl < 1600 N/mm²	Stahl < 55 HRC	Stahl < 60 HRC	Stahl < 66 HRC	INOX < 800 N/mm²	INOX > 800 N/mm²	GG	GGG	hochw. Legierungen	Titan	NE-Metalle Cu-Leg.	Graphit & Faserverbund	MMS	max.	ohne	AIR
40-1600																●			●	○

● sehr gut geeignet / very suitable ○ bedingt geeignet / limited suitable

HAM 40-1600

Werkstoffgruppe material group	Ø mm	4	5	6	8	10	12	14	16	20
GFK-CFK	v _c [m/min]	200	200	200	200	200	200	200	200	200
	f _z [mm]	0,035	0,035	0,040	0,040	0,045	0,050	0,055	0,060	0,065
	v _f [mm/min]	5570	4450	4240	3200	2880	2650	2480	2400	2080
	n [1/min]	15900	12700	10600	8000	6400	5300	4500	4000	3200
Graphit & Faserverbund	v _c [m/min]	400	400	400	400	400	400	400	400	400
	f _z [mm]	0,035	0,035	0,040	0,040	0,045	0,050	0,055	0,060	0,065
	v _f [mm/min]	11130	8930	8480	6360	5720	5300	5010	4800	4160
	n [1/min]	31800	25500	21200	15900	12700	10600	9100	8000	6400

HAM 40-5400

Vollhartmetall-Torusfräser solid carbide toric end mill

W+F
 VHM
 Z 2
  30° rechts
 Werk Norm

Typ W
  HA

HSF
  Eckradius
 HSC
 SHRINK FIT

HB

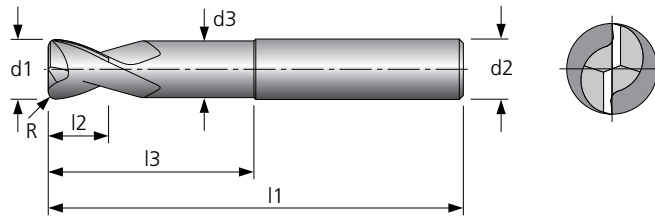



Material	Alu Knet-leg.	Alu Guss-leg.	Stahl < 800 N/mm²	Stahl < 1200 N/mm²	Stahl < 1600 N/mm²	Stahl < 55 HRC	Stahl < 60 HRC	Stahl < 66 HRC	INOX < 800 N/mm²	INOX > 800 N/mm²	GG	GGG	hochw. Legierungen	Titan	NE-Metalle Cu-Leg.	Graphit & Faserverbund	MMS	max.	ohne	AIR
40-5400	●	●													●	○	●	●	○	○

● sehr gut geeignet / very suitable ○ bedingt geeignet / limited suitable





HAM 40-5400

Werkstoffgruppe material group	Ø mm	1	2	3	4	5	6	8	10	12	16
Alu Knetlegierungen	v_c [m/min]	400	400	400	400	400	400	400	400	400	400
	f_z [mm]	0,007	0,010	0,020	0,040	0,050	0,060	0,080	0,120	0,150	0,200
	v_f [mm/min]	700	1000	1700	2540	2550	2540	2540	3050	3180	3200
	n [1/min]	min. 50000	min. 50000	42400	31800	25500	21200	15900	12700	10600	8000
Alu Gusslegierungen	v_c [m/min]	320	320	320	320	320	320	320	320	320	320
	f_z [mm]	0,005	0,008	0,016	0,030	0,040	0,050	0,070	0,100	0,120	0,160
	v_f [mm/min]	500	800	1090	1530	1630	1700	1780	2040	2040	2050
	n [1/min]	min. 50000	min. 50000	34000	25500	20400	17000	12700	10200	8500	6400
NE-Metalle Cu-Legierungen	v_c [m/min]	240	240	240	240	240	240	240	240	240	240
	f_z [mm]	0,010	0,025	0,050	0,060	0,070	0,080	0,100	0,140	0,160	0,220
	v_f [mm/min]	1000	1910	2550	2290	2140	2030	1900	2130	2050	2110
	n [1/min]	min. 50000	38200	25500	19100	15300	12700	9500	7600	6400	4800
Graphit & Faserverbund	v_c [m/min]	260	260	260	260	260	260	260	260	260	260
	f_z [mm]	0,010	0,025	0,050	0,060	0,070	0,080	0,100	0,140	0,160	0,220
	v_f [mm/min]	1000	2070	2760	2480	2320	2210	2060	2320	2210	2290
	n [1/min]	min. 50000	41400	27600	20700	16600	13800	10300	8300	6900	5200

		Alu Knet-leg.	Alu Guss-leg.	NE-Metalle Cu-Leg.	Graphit & Faserverbund
	a_p	0,5 x D	0,5 x D	0,5 x D	0,5 x D
	a_e	1 x D	1 x D	1 x D	1 x D
	a_p	1 x D	1 x D	1 x D	1 x D
	a_e	0,2 x D	0,2 x D	0,2 x D	0,2 x D
	v_c	x 1,5	x 1,5	x 1,5	x 1,5
	f_z	x 1,2	x 1,2	x 1,2	x 1,2

HAM 40-5460

Vollhartmetall-Torusfräser
solid carbide toric end mill

W+F
 VHM
 Z 2
  30° rechts
  Werk Norm
 Typ W
  DIN 6535 HA
 HSF
  Eckradius
 HSC
 SHRINK FIT

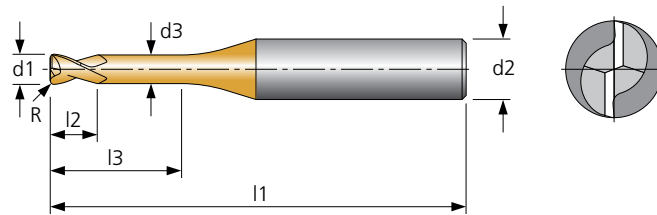



Material	Alu Knetleg.	Alu Gussleg.	Stahl < 800 N/mm²	Stahl < 1200 N/mm²	Stahl < 1600 N/mm²	Stahl < 55 HRC	Stahl < 60 HRC	Stahl < 66 HRC	INOX < 800 N/mm²	INOX > 800 N/mm²	GG	GGG	hochw. Legierungen	Titan	NE-Metalle Cu-Leg.	Graphit & Faserverbund	MMS	max.	ohne	AIR
40-5460	●	●							○	○				○	●	○	●	●	○	○

● sehr gut geeignet / very suitable ○ bedingt geeignet / limited suitable

HAM 40-5460

Werkstoffgruppe material group	Ø mm	0,2	0,5	0,8	1	1,5	2	2,5	3	4	5	6
Alu Knetlegierungen	V _c [m/min]	600	600	600	600	600	600	600	600	600	600	600
	f _z [mm]	0,010	0,020	0,030	0,040	0,050	0,062	0,074	0,087	0,100	0,113	0,130
	V _f [mm/min]	1000	2000	3000	4000	5000	6200	7400	8700	9540	8630	8270
	n [1/min]	min. 50000	min. 50000	min. 50000	min. 50000	min. 50000	min. 50000	min. 50000	min. 50000	min. 50000	47700	38200
Alu Gusslegierungen	V _c [m/min]	480	480	480	480	480	480	480	480	480	480	480
	f _z [mm]	0,009	0,017	0,026	0,034	0,043	0,053	0,063	0,074	0,085	0,096	0,111
	V _f [mm/min]	850	1700	2550	3400	4250	5270	6290	7400	6490	5880	5640
	n [1/min]	min. 50000	min. 50000	min. 50000	min. 50000	min. 50000	min. 50000	min. 50000	min. 50000	min. 50000	38200	30600
INOX < 800 N/mm²	V _c [m/min]	130	130	130	130	130	130	130	130	130	130	130
	f _z [mm]	0,004	0,008	0,012	0,016	0,020	0,025	0,030	0,035	0,040	0,045	0,052
	V _f [mm/min]	400	800	1200	1320	1100	1030	980	960	820	750	720
	n [1/min]	min. 50000	min. 50000	min. 50000	41400	27600	20700	16600	13800	10300	8300	6900
INOX > 800 N/mm²	V _c [m/min]	90	90	90	90	90	90	90	90	90	90	90
	f _z [mm]	0,003	0,007	0,010	0,013	0,017	0,021	0,025	0,029	0,034	0,038	0,044
	V _f [mm/min]	340	670	720	770	640	590	570	550	480	430	420
	n [1/min]	min. 50000	min. 50000	35800	28600	19100	14300	11500	9500	7200	5700	4800
Titan	V _c [m/min]	110	110	110	110	110	110	110	110	110	110	110
	f _z [mm]	0,003	0,007	0,010	0,013	0,017	0,021	0,025	0,029	0,034	0,038	0,044
	V _f [mm/min]	340	670	880	940	780	730	690	680	590	530	510
	n [1/min]	min. 50000	min. 50000	43800	35000	23300	17500	14000	11700	8800	7000	5800
NE-Metalle Cu-Legierungen	V _c [m/min]	360	360	360	360	360	360	360	360	360	360	360
	f _z [mm]	0,010	0,020	0,030	0,040	0,050	0,062	0,074	0,087	0,100	0,113	0,130
	V _f [mm/min]	1000	2000	3000	4000	5000	6200	6780	6650	5720	5180	4970
	n [1/min]	min. 50000	min. 50000	min. 50000	min. 50000	min. 50000	min. 50000	45800	38200	28600	22900	19100
Graphit & Faserverbund	V _c [m/min]	390	390	390	390	390	390	390	390	390	390	390
	f _z [mm]	0,013	0,026	0,039	0,052	0,065	0,081	0,096	0,113	0,130	0,147	0,169
	V _f [mm/min]	1300	2600	3900	5200	6500	8060	9560	9360	8060	7290	7000
	n [1/min]	min. 50000	min. 50000	min. 50000	min. 50000	min. 50000	min. 50000	49700	41400	31000	24800	20700

		< 4 x D	< 8 x D	< 12 x D	> 12 x D
	a _p	1,2 x D	1,2 x D	1,2 x D	1,2 x D
	a _e	0,1 x D	0,1 x D	0,1 x D	0,1 x D
	v _c	x 1	x 0,8	x 0,7	x 0,6
	f _z	x 1	x 0,8	x 0,6	x 0,5

	v _c	x 0,8
	f _z	x 0,8

HAM 40-5480

Vollhartmetall-Torusfräser
solid carbide toric end mill

W+F VHM Z 2 35° rechts Werk Norm
Typ W DIN 6535 HA
Eckradius HSC SHRINK FIT

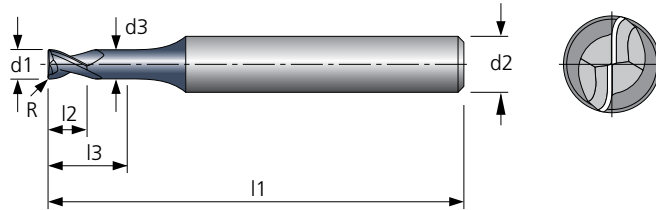

Material	Alu Knet-leg.	Alu Guss-leg.	Stahl < 800 N/mm²	Stahl < 1200 N/mm²	Stahl < 1600 N/mm²	Stahl < 55 HRC	Stahl < 60 HRC	Stahl < 66 HRC	INOX < 800 N/mm²	INOX > 800 N/mm²	GG	GGG	hochw. Legierungen	Titan	NE-Metalle Cu-Leg.	Graphit & Faserverbund	MMS	max.	ohne	AIR
40-5480																●	○			

● sehr gut geeignet / very suitable ○ bedingt geeignet / limited suitable

HAM 40-5480

Werkstoffgruppe material group	Ø mm	0,2			0,3			0,4			0,5		
	l3 mm	0,5	1	1,5	1	2	3	2	3	4	3	5	8
Graphit & Faserverbund	v _c [m/min]	780	625	625	780	625	545	780	625	545	715	585	470
	f _z [mm]	0,008	0,007	0,006	0,011	0,008	0,006	0,017	0,014	0,008	0,022	0,018	0,011
	v _f [mm/min]	840	700	560	1120	840	560	1680	1400	840	2240	1820	1120
	n [1/min]	min. 50000	min. 50000	min. 50000	min. 50000	min. 50000	min. 50000	min. 50000	min. 50000	min. 50000	min. 50000	min. 50000	min. 50000

Werkstoffgruppe material group	Ø mm	0,6			0,8				1				
	l3 mm	3	5	8	4	6	8	10	6	10	14	18	24
Graphit & Faserverbund	v _c [m/min]	780	625	470	780	625	545	470	715	545	495	430	390
	f _z [mm]	0,028	0,024	0,015	0,035	0,031	0,028	0,021	0,042	0,032	0,025	0,018	0,013
	v _f [mm/min]	2800	2380	1540	3500	3080	2800	2100	4200	3220	2520	1820	1260
	n [1/min]	min. 50000	min. 50000	min. 50000	min. 50000	min. 50000	min. 50000	min. 50000	min. 50000	min. 50000	min. 50000	min. 50000	min. 50000

Werkstoffgruppe material group	Ø mm	1,2				1,5					
	l3 mm	6	10	14	18	24	6	10	14	18	24
Graphit & Faserverbund	v _c [m/min]	780	625	545	495	430	780	715	625	545	495
	f _z [mm]	0,049	0,042	0,031	0,025	0,017	0,056	0,042	0,036	0,031	0,025
	v _f [mm/min]	4900	4200	3080	2520	1680	5600	4200	3640	3080	2520
	n [1/min]	min. 50000	min. 50000	min. 50000	min. 50000	min. 50000	min. 50000	min. 50000	min. 50000	min. 50000	min. 50000

Werkstoffgruppe material group	Ø mm	2					2,5			
	l3 mm	6	10	14	18	24	30	10	20	30
Graphit & Faserverbund	v _c [m/min]	780	780	715	625	545	495	780	625	545
	f _z [mm]	0,070	0,063	0,056	0,049	0,039	0,028	0,070	0,056	0,039
	v _f [mm/min]	7000	6300	5600	4900	3920	2800	7000	5600	3920
	n [1/min]	min. 50000	min. 50000	min. 50000	min. 50000	min. 50000	min. 50000	min. 50000	min. 50000	min. 50000

Werkstoffgruppe material group	Ø mm	3					4					
	l3 mm	6	10	14	18	24	30	10	14	18	24	30
Graphit & Faserverbund	v _c [m/min]	780	780	780	715	625	545	780	780	780	715	625
	f _z [mm]	0,084	0,070	0,063	0,056	0,049	0,042	0,084	0,077	0,070	0,063	0,056
	v _f [mm/min]	8400	7000	6300	5600	4900	4200	8400	7700	7000	6300	5570
	n [1/min]	min. 50000	min. 50000	min. 50000	min. 50000	min. 50000	min. 50000	min. 50000	min. 50000	min. 50000	min. 50000	49700

Werkstoffgruppe material group	Ø mm	5				6				
	l3 mm	10	20	30	40	12	20	30	40	50
Graphit & Faserverbund	v _c [m/min]	780	780	715	625	780	780	780	715	624
	f _z [mm]	0,112	0,098	0,077	0,053	0,126	0,115	0,098	0,078	0,056
	v _f [mm/min]	11130	9740	7010	4230	10430	9510	8110	5940	3710
	n [1/min]	49700	49700	45500	39800	41400	41400	41400	37900	33100

		▽	▽▽
	< 4 x D	a _p	0,5 x D
		a _e	0,1 x D
	< 8 x D	a _p	0,5 x D
		a _e	0,1 x D
< 12 x D	a _p	0,4 x D	
	a _e	0,1 x D	
> 12 x D	a _p	0,3 x D	
	a _e	0,1 x D	

HAM 40-6120 / 6130 Vollhartmetall-Torusfräser
solid carbide toric end mill

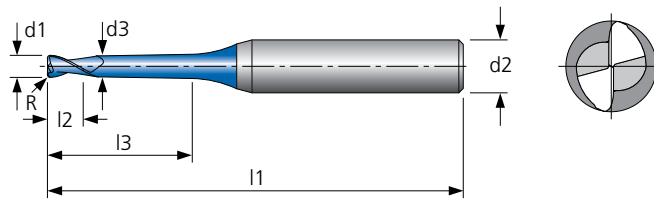
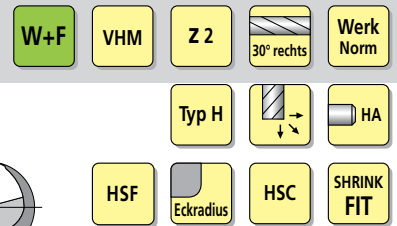

Material	Alu Knet-leg.	Alu Guss-leg.	Stahl < 800 N/mm²	Stahl < 1200 N/mm²	Stahl < 1600 N/mm²	Stahl < 55 HRC	Stahl < 60 HRC	Stahl < 66 HRC	INOX < 800 N/mm²	INOX > 800 N/mm²	GG	GGG	hochw. Legierungen	Titan	NE-Metalle Cu-Leg.	Graphit & Faser-verbund	MMS	max.	ohne	AIR
40-6120 / 40-6130			○	●	●	●	●		○	○	●	●					●		●	●

● sehr gut geeignet / very suitable ○ bedingt geeignet / limited suitable

HAM 40-6120 / 40-6130

Ø	l3	R	Stahl < 800 N/mm²			Stahl < 1200 N/mm²			Stahl < 1600 N/mm²			Stahl < 60 HRC		
			GG			GGG			Stahl < 55 HRC					
			n [1/min]	fz [mm]	ap	n [1/min]	fz [mm]	ap	n [1/min]	fz [mm]	ap	INOX < 800 N/mm²	INOX > 800 N/mm²	n [1/min]
0,2	0,5	0,05	42000	0,013	0,018	42000	0,011	0,016	38000	0,010	0,011	35000	0,010	0,010
0,2	1	0,05	42000	0,013	0,013	42000	0,011	0,011	38000	0,010	0,008	35000	0,010	0,006
0,2	1,5	0,05	42000	0,011	0,007	42000	0,010	0,006	38000	0,008	0,005	32000	0,008	0,004
0,3	1	0,05	42000	0,017	0,017	40000	0,012	0,015	36000	0,011	0,012	33000	0,010	0,010
0,3	2	0,05	38000	0,014	0,011	35500	0,010	0,010	32000	0,008	0,008	30000	0,008	0,006
0,3	3	0,05	34000	0,011	0,005	32000	0,008	0,007	28000	0,006	0,005	26000	0,006	0,005
0,4	2	0,1	35500	0,018	0,021	34000	0,017	0,020	30000	0,014	0,018	28000	0,013	0,016
0,4	3	0,1	32000	0,016	0,012	30000	0,014	0,011	26500	0,013	0,010	25000	0,012	0,008
0,4	4	0,1	32000	0,014	0,008	30000	0,012	0,007	26000	0,009	0,007	24500	0,009	0,006
0,5	2	0,1	37000	0,022	0,026	36000	0,020	0,023	32000	0,016	0,018	30000	0,013	0,017
0,5	4	0,1	32000	0,020	0,018	32000	0,017	0,015	30000	0,014	0,012	28000	0,012	0,010
0,5	6	0,1	32000	0,020	0,015	30000	0,013	0,013	28000	0,011	0,011	28000	0,009	0,009
0,5	8	0,1	32000	0,018	0,013	30000	0,012	0,010	28000	0,010	0,010	28000	0,008	0,008
0,6	2	0,1	36000	0,024	0,030	36000	0,022	0,026	32000	0,020	0,020	29000	0,018	0,018
0,6	4	0,1	34000	0,021	0,020	34000	0,020	0,018	26000	0,019	0,018	24000	0,012	0,014
0,6	6	0,1	32000	0,020	0,012	32000	0,018	0,011	26000	0,016	0,010	24000	0,010	0,008
0,6	8	0,1	30000	0,018	0,010	30000	0,016	0,009	25000	0,013	0,007	22500	0,010	0,007
0,6	10	0,1	30000	0,016	0,007	28000	0,014	0,007	24000	0,012	0,005	21000	0,009	0,005
0,7	2	0,1	36000	0,024	0,030	36000	0,023	0,026	32000	0,020	0,020	29000	0,018	0,018
0,7	4	0,1	34000	0,021	0,020	34000	0,021	0,018	26000	0,019	0,018	24000	0,012	0,014
0,7	6	0,1	32000	0,020	0,012	32000	0,019	0,011	26000	0,016	0,010	24000	0,010	0,008
0,7	8	0,1	30000	0,018	0,010	30000	0,017	0,009	25000	0,013	0,007	22500	0,010	0,007
0,7	10	0,1	30000	0,016	0,007	28000	0,014	0,007	24000	0,012	0,005	21000	0,009	0,005
0,8	2	0,2	36000	0,024	0,060	36000	0,021	0,050	32000	0,019	0,041	29000	0,017	0,038
0,8	4	0,2	34000	0,024	0,050	34000	0,021	0,040	26000	0,019	0,033	24000	0,017	0,030
0,8	6	0,2	32000	0,022	0,025	32000	0,020	0,021	26000	0,017	0,020	22500	0,015	0,018
0,8	8	0,2	30000	0,021	0,018	30000	0,017	0,016	25000	0,014	0,014	21000	0,012	0,011
0,8	10	0,2	30000	0,018	0,012	28000	0,015	0,010	24000	0,010	0,008	21000	0,008	0,008
0,9	6	0,2	32000	0,022	0,025	32000	0,020	0,021	26000	0,017	0,020	22500	0,015	0,018
0,9	8	0,2	30000	0,021	0,018	30000	0,017	0,016	25000	0,014	0,014	21000	0,012	0,011
0,9	10	0,2	30000	0,018	0,012	28000	0,015	0,010	24000	0,010	0,008	21000	0,008	0,008
0,9	15	0,2	35000	0,016	0,010	24000	0,013	0,010	24000	0,080	0,006	21000	0,006	0,008
1	6	0,2	30000	0,030	0,033	28000	0,030	0,030	25000	0,027	0,026	22500	0,025	0,024
1	8	0,2	30000	0,027	0,030	28000	0,025	0,027	25000	0,025	0,026	22500	0,024	0,022
1	10	0,2	29000	0,027	0,026	28000	0,025	0,023	24500	0,023	0,016	22500	0,020	0,015
1	12	0,2	29000	0,025	0,020	25000	0,022	0,018	22000	0,021	0,015	20000	0,020	0,013
1	14	0,2	26000	0,024	0,018	25000	0,020	0,014	22000	0,018	0,013	20000	0,016	0,011
1	16	0,2	26000	0,023	0,013	24500	0,020	0,010	21000	0,017	0,008	20000	0,015	0,006
1,2	6	0,2	30000	0,030	0,033	28000	0,030	0,030	25000	0,027	0,026	22500	0,025	0,024
1,2	8	0,2	30000	0,027	0,030	28000	0,025	0,027	25000	0,025	0,026	22500	0,024	0,022
1,2	10	0,2	29000	0,027	0,026	28000	0,025	0,023	24500	0,023	0,016	22500	0,020	0,015
1,2	12	0,2	29000	0,025	0,020	25000	0,022	0,018	22000	0,021	0,015	20000	0,020	0,013
1,4	6	0,2	25000	0,035	0,062	24000	0,033	0,052	23000	0,031	0,043	20000	0,028	0,038
1,4	8	0,2	24500	0,032	0,061	23500	0,030	0,044	22500	0,028	0,038	18500	0,026	0,034
1,4	10	0,2	24500	0,030	0,053	23500	0,028	0,044	22500	0,026	0,038	18500	0,025	0,031
1,4	12	0,2	24000	0,030	0,053	23000	0,028	0,043	22000	0,026	0,036	17500	0,025	0,031
1,4	14	0,2	23500	0,028	0,036	22500	0,026	0,043	21000	0,024	0,034	17500	0,022	0,028
1,4	16	0,2	23500	0,028	0,032	22500	0,026	0,030	21000	0,024	0,023	16000	0,022	0,022

HAM 40-6120 / 40-6130

Ø	l3	R	Stahl < 800 N/mm²			Stahl < 1200 N/mm²			Stahl < 1600 N/mm²			Stahl < 60 HRC		
			GG			GGG			Stahl < 55 HRC					
			n [1/min]	fz [mm]	ap	n [1/min]	fz [mm]	ap	n [1/min]	fz [mm]	ap	INOX < 800 N/mm²	INOX > 800 N/mm²	n [1/min]
1,5	6	0,2	25000	0,035	0,064	24000	0,033	0,054	23000	0,031	0,045	20000	0,028	0,040
1,5	8	0,2	24500	0,032	0,062	23500	0,030	0,046	22500	0,028	0,040	18500	0,026	0,036
1,5	10	0,2	24500	0,030	0,055	23500	0,028	0,046	22500	0,026	0,040	18500	0,025	0,033
1,5	12	0,2	24000	0,030	0,055	23000	0,028	0,045	22000	0,026	0,038	17500	0,025	0,033
1,5	14	0,2	23500	0,028	0,038	22500	0,026	0,045	21000	0,024	0,036	17500	0,022	0,030
1,5	16	0,2	23500	0,028	0,034	22500	0,026	0,030	21000	0,024	0,025	16000	0,022	0,025
1,5	18	0,2	22000	0,026	0,034	21000	0,024	0,030	20000	0,020	0,023	16000	0,018	0,022
1,5	20	0,2	22000	0,026	0,032	21000	0,024	0,028	19500	0,020	0,020	15500	0,018	0,020
1,6	6	0,2	25000	0,035	0,064	24000	0,033	0,054	23000	0,031	0,045	20000	0,028	0,040
1,6	8	0,2	24500	0,032	0,062	23500	0,030	0,046	22500	0,028	0,040	18500	0,026	0,036
1,6	10	0,2	24500	0,030	0,055	23500	0,028	0,046	22500	0,026	0,040	18500	0,025	0,033
1,6	12	0,2	24000	0,030	0,055	23000	0,028	0,045	22000	0,026	0,038	17500	0,025	0,033
1,6	14	0,2	23500	0,028	0,038	22500	0,026	0,045	21000	0,024	0,036	17500	0,022	0,030
1,6	16	0,2	23500	0,028	0,034	22500	0,026	0,030	21000	0,024	0,025	16000	0,022	0,025
1,6	18	0,2	22000	0,026	0,034	21000	0,024	0,030	20000	0,020	0,023	16000	0,018	0,022
1,6	20	0,2	22000	0,026	0,032	21000	0,024	0,028	19500	0,020	0,020	15500	0,018	0,020
1,8	6	0,2	20000	0,055	0,120	18000	0,050	0,110	16500	0,045	0,090	15500	0,040	0,080
1,8	8	0,2	20000	0,052	0,117	18000	0,047	0,091	16000	0,041	0,065	15000	0,037	0,052
1,8	10	0,2	18000	0,051	0,065	18000	0,045	0,055	16000	0,039	0,052	15000	0,035	0,040
1,8	12	0,2	18000	0,050	0,060	17500	0,044	0,052	16000	0,038	0,040	15000	0,034	0,035
1,8	14	0,2	18000	0,045	0,055	17000	0,400	0,050	15000	0,035	0,036	14000	0,032	0,029
1,8	16	0,2	17500	0,040	0,050	16000	0,035	0,044	14500	0,032	0,032	13000	0,030	0,026
1,8	18	0,2	17000	0,037	0,045	15000	0,032	0,035	14000	0,030	0,029	13000	0,027	0,025
1,8	20	0,2	16000	0,035	0,038	14000	0,029	0,032	14000	0,027	0,026	12000	0,022	0,023
2	6	0,2 / 0,5	20000	0,072	0,185	18000	0,068	0,160	16500	0,060	0,100	15500	0,058	0,090
2	8	0,2 / 0,5	20000	0,068	0,120	18000	0,061	0,111	16000	0,056	0,090	15000	0,054	0,081
2	10	0,2 / 0,5	18000	0,064	0,071	18000	0,060	0,068	16000	0,055	0,060	15000	0,054	0,050
2	12	0,2 / 0,5	18000	0,060	0,064	17500	0,056	0,060	16000	0,050	0,054	15000	0,046	0,047
2	14	0,2 / 0,5	18000	0,058	0,062	17000	0,052	0,058	15000	0,048	0,052	14000	0,046	0,042
2	16	0,2 / 0,5	17500	0,055	0,059	16000	0,050	0,047	14500	0,045	0,042	13000	0,042	0,040
2	18	0,2 / 0,5	17000	0,052	0,050	15000	0,047	0,042	14000	0,042	0,038	13000	0,040	0,038
2	20	0,2 / 0,5	16000	0,050	0,042	14000	0,042	0,038	14000	0,037	0,032	12000	0,035	0,034
2	25	0,2 / 0,5	14000	0,046	0,035	14000	0,038	0,030	12500	0,032	0,026	11500	0,030	0,030
2	30	0,2 / 0,5	13000	0,042	0,028	12000	0,034	0,024	12000	0,028	0,200	11000	0,026	0,023
2,5	8	0,25	22000	0,055	0,175	18000	0,043	0,140	11000	0,040	0,120	11500	0,030	0,100
2,5	10	0,25	18000	0,053	0,170	18000	0,043	0,135	11000	0,038	0,100	11000	0,030	0,085
2,5	12	0,25	18000	0,053	0,162	18000	0,041	0,126	10800	0,036	0,090	10800	0,029	0,072
2,5	14	0,25	18000	0,050	0,140	17500	0,040	0,100	10500	0,036	0,071	10500	0,029	0,060
2,5	16	0,25	17500	0,050	0,120	17500	0,040	0,085	10000	0,035	0,060	10200	0,028	0,050
2,5	18	0,25	17500	0,048	0,105	17500	0,039	0,075	9800	0,033	0,053	9600	0,025	0,043
2,5	20	0,25	17000	0,048	0,090	17000	0,037	0,070	9800	0,031	0,050	9000	0,025	0,040
2,5	25	0,25	17000	0,045	0,075	17000	0,035	0,065	9000	0,029	0,045	8500	0,021	0,035
2,5	30	0,25	17000	0,042	0,065	17000	0,032	0,060	9000	0,027	0,040	8000	0,021	0,030
3	8	0,2 / 0,5	18000	0,058	0,265	16000	0,058	0,240	15000	0,054	0,190	14000	0,050	0,180
3	10	0,2 / 0,5	18000	0,058	0,265	16000	0,058	0,240	15000	0,054	0,190	14000	0,050	0,140
3	12	0,2 / 0,5	18000	0,056	0,180	16000	0,056	0,160	15000	0,054	0,130	14000	0,048	0,112
3	14	0,2 / 0,5	15000	0,056	0,150	14000	0,056	0,130	12000	0,052	0,090	12000	0,048	0,070
3	16	0,2 / 0,5	15000	0,056	0,120	13000	0,056	0,110	12000	0,052	0,080	12000	0,048	0,070
3	18	0,2 / 0,5	14000	0,056	0,110	13000	0,056	0,100	11000	0,052	0,070	10000	0,048	0,060
3	20	0,2 / 0,5	14000	0,054	0,110	12000	0,054	0,090	11000	0,052	0,070	10000	0,048	0,060
3	25	0,2 / 0,5	14000	0,054	0,090	12000	0,054	0,060	10000	0,050	0,050	9000	0,045	0,040
3	30	0,2 / 0,5	12000	0,052	0,070	11000	0,052	0,060	10000	0,050	0,050	9000	0,045	0,040
3	35	0,2 / 0,5	12000	0,052	0,060	11000	0,052	0,045	9000	0,048	0,040	8000	0,040	0,038
3	40	0,2 / 0,5	12000	0,052	0,060	11000	0,052	0,045	9000	0,048	0,040	8000	0,040	0,038
4	12	0,5	11000	0,090	0,280	11000	0,085	0,250	10000	0,080	0,190	9000	0,070	0,170
4	16	0,5	11000	0,090	0,200	11000	0,085	0,190	9000	0,075	0,160	8000	0,070	0,130
4	20	0,5	11000	0,090	0,200	11000	0,085	0,190	9000	0,075	0,160	8000	0,070	0,130
4	25	0,5	10000	0,085	0,140	9000	0,082	0,120	8000	0,070	0,100	7500	0,065	0,090
4	30	0,5	9000	0,085	0,110	7500	0,080	0,100	7000	0,070	0,080	6500	0,065	0,070
4	35	0,5	9000	0,085	0,075	7500	0,078	0,068	7000	0,065	0,055	6000	0,060	0,050
4	40	0,5	8500	0,085	0,075	7000	0,078	0,068	6500	0,060	0,050	6000	0,060	0,050
4	45	0,5	7500	0,080	0,060	7000	0,075	0,055	6000	0,060	0,045	5000	0,055	0,040
4	50	0,5	7500	0,080	0,060	7000	0,075	0,055	6000	0,060	0,045	5000	0,055	0,040
5	16	0,5	8500	0,120	0,310	8000	0,125	0,280	7200	0,100	0,210	7000	0,088	0,210
5	25	0,5	8000	0,110	0,122	7300	0,110	0,108	6500	0,090	0,100	6400	0,078	0,090
5	35	0,5	7500	0,110	0,122	7300	0,110	0,108	6400	0,090	0,088	6400	0,078	0,080
5	43	0,5	7500	0,090	0,900	7000	0,090	0,080	6000	0,080	0,070	6000	0,060	0,070
6	10	0,5	8500	0,130	0,310	8000	0,125	0,280	7200	0,100	0,210	7000	0,088	0,210
6	20	0,5	8000	0,120	0,122	7300	0,110	0,108	6500	0,090	0,100	6400	0,078	0,090
6	30	0,5	7500	0,110	0,122	7300	0,110	0,108	6400	0,090	0,088	6400	0,078	0,080
6	40	0,5	7500	0,090	0,900	7000	0,090	0,080	6000	0,080	0,070	6000	0,060	0,070
6	50	0,5	7500	0,080	0,900	7000	0,090	0,080	6000	0,080	0,070	6000	0,060	0,070

HAM 40-5360

Vollhartmetall-Torusfräser
solid carbide toric end mill

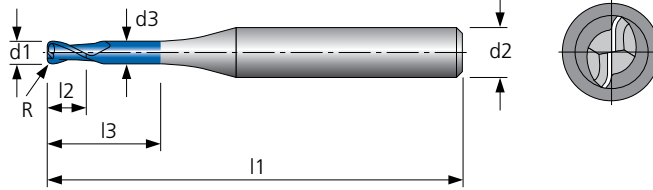
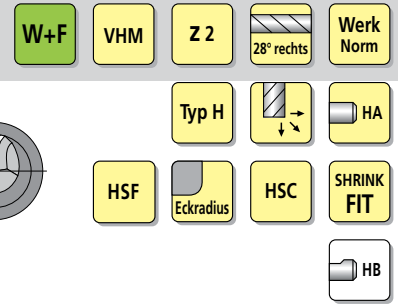

Material	Alu Knet-leg.	Alu Guss-leg.	Stahl < 800 N/mm²	Stahl < 1200 N/mm²	Stahl < 1600 N/mm²	Stahl < 55 HRC	Stahl < 60 HRC	Stahl < 66 HRC	INOX < 800 N/mm²	INOX > 800 N/mm²	GG	GGG	hochw. Legierungen	Titan	NE-Metalle Cu-Leg.	Graphit & Faser-verbund	MMS	max.	ohne	AIR
40-5360			●	●	●	○			○	○	●	●					●		●	●

● sehr gut geeignet / very suitable ○ bedingt geeignet / limited suitable

HAM 40-5360

Werkstoffgruppe material group	Ø mm	0,5	0,6	0,8	1	1,5	2	2,5	3	4	5	6
Stahl < 800 N/mm²	V _c [m/min]	250	250	250	250	250	250	250	250	250	250	250
	f _z [mm]	0,010	0,020	0,020	0,020	0,030	0,030	0,040	0,050	0,070	0,080	0,090
	V _f [mm/min]	1000	2000	2000	2000	3000	2390	2540	2650	2790	2540	2390
	n [1/min]	min. 50000	min. 50000	min. 50000	min. 50000	min. 50000	39800	31800	26500	19900	15900	13300
Stahl < 1200 N/mm²	V _c [m/min]	220	220	220	220	220	220	220	220	220	220	220
	f _z [mm]	0,010	0,010	0,020	0,020	0,020	0,030	0,030	0,040	0,050	0,060	0,080
	V _f [mm/min]	1000	1000	2000	2000	1870	2100	1680	1860	1750	1680	1870
	n [1/min]	min. 50000	min. 50000	min. 50000	min. 50000	46700	35000	28000	23300	17500	14000	11700
Stahl < 1600 N/mm²	V _c [m/min]	200	200	200	200	200	200	200	200	200	200	200
	f _z [mm]	0,010	0,010	0,010	0,010	0,020	0,020	0,030	0,040	0,050	0,060	0,060
	V _f [mm/min]	1000	1000	1000	1000	1700	1270	1530	1700	1590	1520	1270
	n [1/min]	min. 50000	min. 50000	min. 50000	min. 50000	42400	31800	25500	21200	15900	12700	10600
Stahl < 55 HRC	V _c [m/min]	150	150	150	150	150	150	150	150	150	150	150
	f _z [mm]	0,010	0,010	0,010	0,010	0,010	0,020	0,020	0,030	0,040	0,050	0,060
	V _f [mm/min]	1000	1000	1000	950	640	960	760	950	950	950	960
	n [1/min]	min. 50000	min. 50000	min. 50000	47700	31800	23900	19100	15900	11900	9500	8000
INOX < 800 N/mm²	V _c [m/min]	180	180	180	180	180	180	180	180	180	180	180
	f _z [mm]	0,010	0,010	0,010	0,010	0,020	0,020	0,030	0,030	0,040	0,050	0,060
	V _f [mm/min]	1000	1000	1000	1000	1530	1140	1370	1150	1140	1150	1140
	n [1/min]	min. 50000	min. 50000	min. 50000	min. 50000	38200	28600	22900	19100	14300	11500	9500
INOX > 800 N/mm²	V _c [m/min]	100	100	100	100	100	100	100	100	100	100	100
	f _z [mm]	0,010	0,010	0,010	0,010	0,020	0,020	0,030	0,030	0,040	0,050	0,060
	V _f [mm/min]	1000	1000	800	640	850	640	760	640	640	640	640
	n [1/min]	min. 50000	min. 50000	39800	31800	21200	15900	12700	10600	8000	6400	5300
GG	V _c [m/min]	200	200	200	200	200	200	200	200	200	200	200
	f _z [mm]	0,010	0,010	0,020	0,020	0,020	0,030	0,030	0,040	0,050	0,060	0,080
	V _f [mm/min]	1000	1000	2000	2000	1700	1910	1530	1700	1590	1520	1700
	n [1/min]	min. 50000	min. 50000	min. 50000	min. 50000	42400	31800	25500	21200	15900	12700	10600
GGG	V _c [m/min]	150	150	150	150	150	150	150	150	150	150	150
	f _z [mm]	0,010	0,010	0,010	0,010	0,020	0,020	0,030	0,030	0,040	0,050	0,060
	V _f [mm/min]	1000	1000	1000	950	1270	960	1150	950	950	950	960
	n [1/min]	min. 50000	min. 50000	min. 50000	47700	31800	23900	19100	15900	11900	9500	8000

Auskräglänge projection length		Stahl < 800 N/mm²	Stahl < 1200 N/mm²	Stahl < 1600 N/mm²	Stahl < 55 HRC	INOX < 800 N/mm²	INOX > 800 N/mm²	GG	GGG
< 4 x D	a _p	0,1 x D	0,08 x D	0,07 x D	0,05 x D	0,07 x D	0,05 x D	0,08 x D	0,05 x D
	a _e	0,5 x D	0,5 x D	0,4 x D	0,35 x D	0,5 x D	0,4 x D	0,5 x D	0,4 x D
	V _c	x 1	x 1	x 1	x 1	x 1	x 1	x 1	x 1
	f _z	x 1	x 1	x 1	x 1	x 1	x 1	x 1	x 1
< 6 x D	a _p	0,08 x D	0,08 x D	0,07 x D	0,05 x D	0,07 x D	0,05 x D	0,08 x D	0,05 x D
	a _e	0,45 x D	0,45 x D	0,35 x D	0,3 x D	0,4 x D	0,35 x D	0,4 x D	0,35 x D
	V _c	x 0,95	x 0,95	x 0,95	x 0,95	x 0,95	x 0,95	x 0,95	x 0,95
	f _z	x 0,9	x 0,9	x 0,9	x 0,9	x 0,9	x 0,9	x 0,9	x 0,9
< 8 x D	a _p	0,1 x D	0,08 x D	0,07 x D	0,05 x D	0,07 x D	0,05 x D	0,08 x D	0,05 x D
	a _e	0,4 x D	0,4 x D	0,35 x D	0,3 x D	0,4 x D	0,35 x D	0,4 x D	0,35 x D
	V _c	x 0,9	x 0,9	x 0,9	x 0,9	x 0,9	x 0,9	x 0,9	x 0,9
	f _z	x 0,8	x 0,8	x 0,8	x 0,8	x 0,8	x 0,8	x 0,8	x 0,8
> 8 x D	a _p	0,08 x D	0,08 x D	0,07 x D	0,05 x D	0,07 x D	0,05 x D	0,08 x D	0,05 x D
	a _e	0,4 x D	0,4 x D	0,35 x D	0,3 x D	0,4 x D	0,35 x D	0,4 x D	0,35 x D
	V _c	x 0,8	x 0,8	x 0,8	x 0,8	x 0,8	x 0,8	x 0,8	x 0,8
	f _z	x 0,6	x 0,6	x 0,6	x 0,6	x 0,6	x 0,6	x 0,6	x 0,6

HAM 40-5600

Vollhartmetall-Torusfräser
solid carbide toric end mill

W+F VHM Z 4 35° rechts Werk Norm
Typ W DIN 6535 HA
Eckradius HSC SHRINK FIT

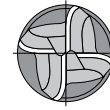
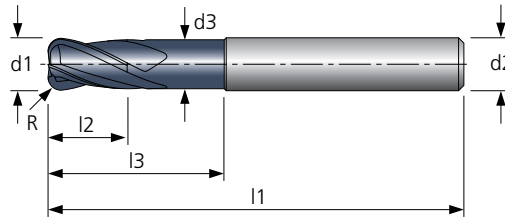

Material	Alu Knet-leg.	Alu Guss-leg.	Stahl < 800 N/mm²	Stahl < 1200 N/mm²	Stahl < 1600 N/mm²	Stahl < 55 HRC	Stahl < 60 HRC	Stahl < 66 HRC	INOX < 800 N/mm²	INOX > 800 N/mm²	GG	GGG	hochw. Legierungen	Titan	NE-Metalle Cu-Leg.	Graphit & Faserverbund	MMS	max.	ohne	AIR
40-5600																●	○			

● sehr gut geeignet / very suitable ○ bedingt geeignet / limited suitable

HAM 40-5600

▽								
Werkstoffgruppe material group	Ø mm	2	3	4	6	8	10	12
Graphit & Faserverbund	v _c [m/min]	600	600	600	600	600	600	600
	f _z [mm]	0,030	0,040	0,050	0,080	0,100	0,120	0,150
	v _f [mm/min]	6000	8000	9540	10180	9560	9170	9540
	n [1/min]	min. 50000	min. 50000	47700	31800	23900	19100	15900

▽▽								
Werkstoffgruppe material group	Ø mm	2	3	4	6	8	10	12
Graphit & Faserverbund	v _c [m/min]	800	800	800	800	800	800	800
	f _z [mm]	0,020	0,030	0,040	0,060	0,080	0,100	0,120
	v _f [mm/min]	4000	6000	8000	10180	10180	10200	10170
	n [1/min]	min. 50000	min. 50000	min. 50000	42400	31800	25500	21200

		▽	▽▽
	a _p	0,04 x D	0,04 x D
	a _e	0,05 x D	0,04 x D

HAM 40-5500

Vollhartmetall-Torusfräser
solid carbide toric end mill

W+F VHM Z 3-4 0° Nut Werk Norm

Typ H HA

HSF Eckradius HSC SHRINK FIT

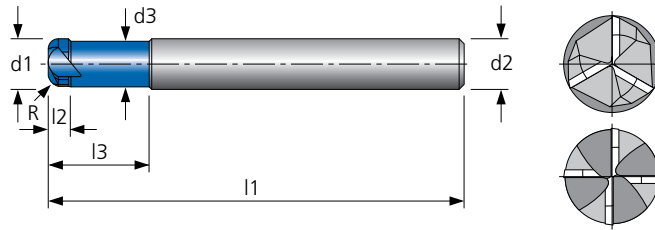

Material	Alu Knet-leg.	Alu Guss-leg.	Stahl < 800 N/mm²	Stahl < 1200 N/mm²	Stahl < 1600 N/mm²	Stahl < 55 HRC	Stahl < 60 HRC	Stahl < 66 HRC	INOX < 800 N/mm²	INOX > 800 N/mm²	GG	GGG	hochw. Legierungen	Titan	NE-Metalle Cu-Leg.	Graphit & Faser-verbund	MMS	max.	ohne	AIR
40-5500			○	●	●	●	●	●			●	●					●		○	●

● sehr gut geeignet / very suitable ○ bedingt geeignet / limited suitable

HAM 40-5500 Standard-Bearbeitung / standard machining

Ø	l3	R	Stahl < 800 N/mm²		Stahl < 1200 N/mm²		Stahl < 1600 N/mm²		Stahl < 60 HRC		Stahl < 66 HRC	
			GG	GGG	GGG	GGG	Stahl < 55 HRC	n [1/min]	fz [mm]	n [1/min]	fz [mm]	n [1/min]
mm	mm	mm	n [1/min]	fz [mm]	n [1/min]	fz [mm]	n [1/min]	fz [mm]	n [1/min]	fz [mm]	n [1/min]	fz [mm]
2	5	0,5	16000	0,10	16000	0,09	12500	0,09	11000	0,08	8000	0,07
3	7,5	0,75	10500	0,15	10500	0,13	8500	0,13	7450	0,12	5300	0,10
4	10	1	8000	0,20	8000	0,18	6400	0,18	5600	0,17	4000	0,13
5	12,5	1,2	6400	0,27	6400	0,24	5100	0,24	4500	0,23	3200	0,17
6	24	1,5	5300	0,33	5300	0,29	4300	0,29	3700	0,28	2650	0,23
7	—	1,5	4550	0,35	4550	0,30	3640	0,30	3180	0,29	2270	0,23
8	32	2	4000	0,43	4000	0,39	3200	0,39	2800	0,38	2000	0,30
9	—	2	3540	0,45	3540	0,40	2830	0,40	2470	0,39	1770	0,31
10	40	2	3200	0,50	3200	0,50	2550	0,50	2250	0,47	1600	0,40
11	—	2	2890	0,50	2890	0,50	2320	0,50	2020	0,47	1450	0,40
12	48	3	2650	0,60	2650	0,60	2100	0,60	1850	0,57	1350	0,47
13	—	3	2450	0,64	2450	0,64	2000	0,64	1700	0,58	1200	0,50
16	28	4	1990	0,80	1990	0,80	1590	0,80	1390	0,75	990	0,70

HAM 40-5500 HSC-Bearbeitung / HSC machining

Ø	l3	R	Stahl < 800 N/mm²		Stahl < 1200 N/mm²		Stahl < 1600 N/mm²		Stahl < 60 HRC		Stahl < 66 HRC	
			GG	GGG	GGG	GGG	Stahl < 55 HRC	n [1/min]	fz [mm]	n [1/min]	fz [mm]	n [1/min]
mm	mm	mm	n [1/min]	fz [mm]	n [1/min]	fz [mm]	n [1/min]	fz [mm]	n [1/min]	fz [mm]	n [1/min]	fz [mm]
2	5	0,5	30000	0,10	26000	0,09	22000	0,07	18000	0,06	16000	0,05
3	7,5	0,75	20200	0,14	17000	0,13	14900	0,12	12800	0,10	10500	0,90
4	10	1	15200	0,19	12800	0,18	11200	0,15	9600	0,13	8000	0,11
5	12,5	1,2	12100	0,25	10200	0,23	8900	0,20	7700	0,17	6400	0,15
6	24	1,5	10100	0,33	8500	0,32	7500	0,30	6400	0,28	5300	0,25
7	—	1,5	8645	0,34	7280	0,33	6370	0,31	5460	0,29	4550	0,26
8	32	2	7600	0,44	6400	0,42	5600	0,41	4800	0,36	4000	0,31
9	—	2	6720	0,45	5660	0,43	4950	0,42	4250	0,37	3540	0,31
10	40	2	6050	0,55	5100	0,53	4500	0,50	3800	0,47	3200	0,40
11	—	2	5500	0,55	4630	0,54	4050	0,51	3470	0,48	2890	0,40
12	48	3	5050	0,65	4250	0,64	3700	0,59	3200	0,54	2650	0,50
13	—	3	4700	0,65	4000	0,65	3450	0,63	3000	0,58	2450	0,51
16	28	4	3780	0,80	3180	0,80	2790	0,80	2380	0,75	1990	0,70

	Stahl < 800 N/mm²	Stahl < 1200 N/mm²	Stahl < 1600 N/mm²	Stahl < 55 HRC	Stahl < 60 HRC	Stahl < 66 HRC	GG	GGG
ap max.	0,15 x R	0,12 x R	0,1 x R	0,1 x R	0,08 x R	0,05 x R	0,15 x R	0,12 x R
ae max.	0,25 x D	0,25 x D	0,25 x D	0,25 x D	0,25 x D	0,25 x D	0,25 x D	0,25 x D

Ausraglänge projection length	< 3 x D	< 5 x D	< 8 x D	< 10 x D
vc	100 %	100 %	90 %	80 %
vf	100 %	100 %	90 %	80 %
ap	100 %	80 %	50 %	25 %

Eintauchwinkel (Rampenwinkel)

für Werkstoffe < 48 HRC 1°
für Werkstoffe > 48 HRC 0,5°
bei Werkstoffen ab 48 HRC bitte den Vorschub um 50 % reduzieren

Plunging angle (ramp angle)

for material < 48 HRC 1°
for material > 48 HRC 0,5°
for material as from 48 HRC please reduce feed 50 %

HAM 40-5520 / 5560 Vollhartmetall-Torusfräser
solid carbide toric end mill

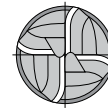
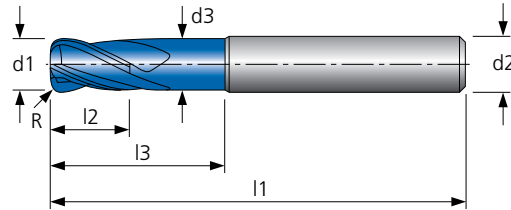
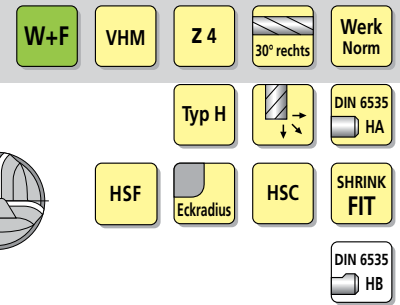

Material	Alu Knet-leg.	Alu Guss-leg.	Stahl < 800 N/mm²	Stahl < 1200 N/mm²	Stahl < 1600 N/mm²	Stahl < 55 HRC	Stahl < 60 HRC	Stahl < 66 HRC	INOX < 800 N/mm²	INOX > 800 N/mm²	GG	GGG	hochw. Legierungen	Titan	NE-Metalle Cu-Leg.	Graphit & Faser-verbund	MMS	max.	ohne	AIR
40-5520 / 40-5560			●	●	●	○			○	○	●	●					●	○	●	●

● sehr gut geeignet / very suitable ○ bedingt geeignet / limited suitable

HAM 40-5520 / 40-5560

Werkstoffgruppe material group	Ø mm	2	3	4	5	6	8	10	12	16
Stahl < 800 N/mm²	v _c [m/min]	200	200	200	200	200	200	200	200	200
	f _z [mm]	0,020	0,030	0,040	0,050	0,060	0,090	0,110	0,132	0,154
	v _f [mm/min]	2540	2540	2540	2540	2540	2880	2820	2800	2460
	n [1/min]	31800	21200	15900	12700	10600	8000	6400	5300	4000
Stahl < 1200 N/mm²	v _c [m/min]	180	180	180	180	180	180	180	180	180
	f _z [mm]	0,020	0,030	0,040	0,050	0,060	0,080	0,100	0,120	0,140
	v _f [mm/min]	2290	2290	2290	2300	2280	2300	2280	2300	2020
	n [1/min]	28600	19100	14300	11500	9500	7200	5700	4800	3600
Stahl < 1600 N/mm²	v _c [m/min]	155	155	155	155	155	155	155	155	155
	f _z [mm]	0,017	0,026	0,034	0,043	0,051	0,077	0,094	0,112	0,131
	v _f [mm/min]	1680	1670	1670	1680	1670	1900	1830	1840	1620
	n [1/min]	24700	16400	12300	9900	8200	6200	4900	4100	3100
Stahl < 55 HRC	v _c [m/min]	108	108	108	108	108	108	108	108	108
	f _z [mm]	0,013	0,020	0,027	0,034	0,040	0,054	0,067	0,080	0,094
	v _f [mm/min]	920	920	920	920	920	920	910	930	790
	n [1/min]	17200	11500	8600	6900	5700	4300	3400	2900	2100
INOX < 800 N/mm²	v _c [m/min]	100	100	100	100	100	100	100	100	100
	f _z [mm]	0,016	0,024	0,032	0,040	0,048	0,064	0,080	0,096	0,115
	v _f [mm/min]	1020	1020	1020	1020	1020	1020	1020	1040	920
	n [1/min]	15900	10600	8000	6400	5300	4000	3200	2700	2000
INOX > 800 N/mm²	v _c [m/min]	70	70	70	70	70	70	70	70	70
	f _z [mm]	0,013	0,020	0,027	0,034	0,040	0,054	0,067	0,080	0,094
	v _f [mm/min]	590	590	600	600	590	600	590	610	530
	n [1/min]	11100	7400	5600	4500	3700	2800	2200	1900	1400
GG	v _c [m/min]	175	175	175	175	175	175	175	175	175
	f _z [mm]	0,022	0,033	0,044	0,055	0,066	0,088	0,110	0,132	0,154
	v _f [mm/min]	2460	2460	2450	2440	2460	2460	2460	2430	2160
	n [1/min]	27900	18600	13900	11100	9300	7000	5600	4600	3500
GGG	v _c [m/min]	155	155	155	155	155	155	155	155	155
	f _z [mm]	0,020	0,030	0,040	0,050	0,060	0,080	0,100	0,120	0,140
	v _f [mm/min]	1900	2000	2000	1960	1960	2000	1960	1980	2000
	n [1/min]	24600	16500	12300	9800	8200	6200	4900	4100	3100

		Stahl < 800 N/mm²	Stahl < 1200 N/mm²	Stahl < 1600 N/mm²	Stahl < 55 HRC	INOX < 800 N/mm²	INOX > 800 N/mm²	GG	GGG
	< 3 x D	a _p	0,15 x D	0,15 x D	0,1 x D	0,07 x D	0,15 x D	0,1 x D	0,15 x D
		a _e	0,25 x D	0,5 x D	0,4 x D	0,35 x D	0,5 x D	0,5 x D	0,4 x D
	> 3 x D	a _p	0,1 x D	0,07 x D	0,05 x D	0,1 x D	0,07 x D	0,1 x D	0,07 x D
		a _e	0,1 x D	0,5 x D	0,4 x D	0,35 x D	0,5 x D	0,5 x D	0,4 x D

HAM 40-5860

Vollhartmetall-Radiusfräser
solid carbide ball nose end mill

W+F VHM Z 2 30° rechts Werk Norm

Typ W 30° links HA

HSF HSC SHRINK FIT

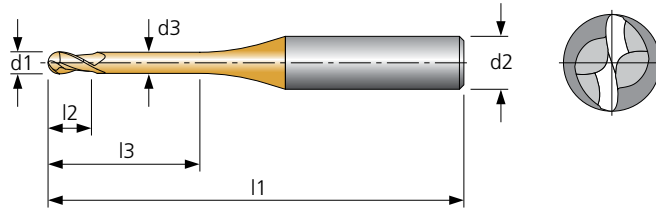

Material	Alu Knet-leg.	Alu Guss-leg.	Stahl < 800 N/mm²	Stahl < 1200 N/mm²	Stahl < 1600 N/mm²	Stahl < 55 HRC	Stahl < 60 HRC	Stahl < 66 HRC	INOX < 800 N/mm²	INOX > 800 N/mm²	GG	GGG	hochw. Legierungen	Titan	NE-Metalle Cu-Leg.	Graphit & Faserverbund	MMS	max.	ohne	AIR	
40-5860	●	●							○	○				○	○	○	○	○	○	○	○

● sehr gut geeignet / very suitable ○ bedingt geeignet / limited suitable

HAM 40-5860

Werkstoffgruppe material group	Ø mm	0,2	0,5	0,8	1	1,5	2	2,5	3	4	5	6
Alu Knetlegierungen	V _c [m/min]	540	540	540	540	540	540	540	540	540	540	540
	f _z [mm]	0,007	0,015	0,023	0,031	0,040	0,048	0,057	0,067	0,077	0,087	0,100
	v _f [mm/min]	700	1500	2300	3100	4000	4800	5700	6700	6620	5990	5720
	n [1/min]	min. 50000	min. 50000	min. 50000	min. 50000	min. 50000	min. 50000	min. 50000	min. 50000	min. 50000	43000	34400
Alu Gusslegierungen	V _c [m/min]	430	430	430	430	430	430	430	430	430	430	430
	f _z [mm]	0,006	0,013	0,020	0,026	0,034	0,041	0,048	0,057	0,065	0,074	0,085
	v _f [mm/min]	600	1280	1960	2640	3400	4080	4850	5190	4480	4050	3880
	n [1/min]	min. 50000	min. 50000	min. 50000	min. 50000	min. 50000	min. 50000	min. 50000	min. 50000	45600	34200	27400
INOX < 800 N/mm²	V _c [m/min]	115	115	115	115	115	115	115	115	115	115	115
	f _z [mm]	0,004	0,008	0,012	0,017	0,021	0,026	0,030	0,036	0,041	0,046	0,053
	v _f [mm/min]	370	800	1120	1210	1040	940	890	870	760	680	650
	n [1/min]	min. 50000	min. 50000	45800	36600	24400	18300	14600	12200	9200	7300	6100
INOX > 800 N/mm²	V _c [m/min]	80	80	80	80	80	80	80	80	80	80	80
	f _z [mm]	0,003	0,007	0,010	0,014	0,018	0,021	0,025	0,030	0,034	0,039	0,045
	v _f [mm/min]	310	670	650	710	610	540	520	510	440	400	380
	n [1/min]	min. 50000	min. 50000	31800	25500	17000	12700	10200	8500	6400	5100	4200
Titan	V _c [m/min]	100	100	100	100	100	100	100	100	100	100	100
	f _z [mm]	0,003	0,007	0,010	0,014	0,018	0,021	0,025	0,030	0,034	0,039	0,045
	v _f [mm/min]	310	670	820	880	760	680	650	630	550	500	470
	n [1/min]	min. 50000	min. 50000	39800	31800	21200	15900	12700	10600	8000	6400	5300
NE-Metalle Cu-Legierungen	V _c [m/min]	325	325	325	325	325	325	325	325	325	325	325
	f _z [mm]	0,007	0,015	0,023	0,031	0,040	0,048	0,057	0,067	0,077	0,087	0,100
	v _f [mm/min]	700	1500	2300	3100	4000	4800	4720	4620	3990	3600	3440
	n [1/min]	min. 50000	min. 50000	min. 50000	min. 50000	min. 50000	min. 50000	41400	34500	25900	20700	17200
Graphit & Faserverbund	V _c [m/min]	350	350	350	350	350	350	350	350	350	350	350
	f _z [mm]	0,009	0,020	0,030	0,040	0,052	0,062	0,074	0,087	0,100	0,113	0,130
	v _f [mm/min]	910	1950	2990	4030	5200	6240	6610	6460	5590	5040	4840
	n [1/min]	min. 50000	min. 50000	min. 50000	min. 50000	min. 50000	min. 50000	44600	37100	27900	22300	18600

		< 4 x D	< 8 x D	< 12 x D	> 12 x D
	a _p	1,2 x D	1,2 x D	1,2 x D	1,2 x D
	a _e	0,1 x D	0,1 x D	0,1 x D	0,1 x D
	v _c	x 1,1	x 0,9	x 0,8	x 0,65
	f _z	x 1,2	x 1	x 0,8	x 0,6
	a _p	0,2 x D	0,2 x D	0,2 x D	0,2 x D
	a _e	1 x D	1 x D	1 x D	1 x D
	v _c	x 1	x 0,8	x 0,7	x 0,6
	f _z	x 1	x 0,8	x 0,65	x 0,5
	a _p	0,1 x D	0,1 x D	0,1 x D	0,1 x D
	a _e	0,1 x D	0,1 x D	0,1 x D	0,1 x D
	v _c	x 1,2	x 1	x 0,85	x 0,7
	f _z	x 1,5	x 1,2	x 1	x 0,75

HAM 40-5880

Vollhartmetall-Radiusfräser
solid carbide ball nose end mill

W+F VHM Z 2 35° rechts Werk Norm
Typ W DIN 6535 HA
HSC SHRINK FIT

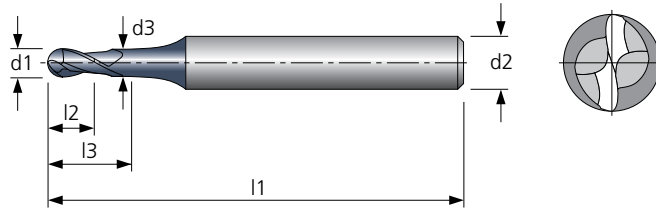

Material	Alu Knet-leg.	Alu Guss-leg.	Stahl < 800 N/mm²	Stahl < 1200 N/mm²	Stahl < 1600 N/mm²	Stahl < 55 HRC	Stahl < 60 HRC	Stahl < 66 HRC	INOX < 800 N/mm²	INOX > 800 N/mm²	GG	GGG	hochw. Legierungen	Titan	NE-Metalle Cu-Leg.	Graphit & Faserverbund	MMS	max.	ohne	AIR
40-5880																●	○		●	

● sehr gut geeignet / very suitable ○ bedingt geeignet / limited suitable

HAM 40-5880

Werkstoffgruppe material group	Ø mm	0,2			0,3			0,4			0,5		
	l3 mm	0,5	1	1,5	1	2	3	2	3	4	3	5	8
Graphit & Faserverbund	v _c [m/min]	780	625	625	780	625	545	780	625	545	715	585	470
	f _z [mm]	0,008	0,007	0,006	0,011	0,008	0,006	0,017	0,014	0,008	0,022	0,018	0,011
	v _f [mm/min]	840	700	560	1120	840	560	1680	1400	840	2240	1820	1120
	n [1/min]	min. 50000	min. 50000	min. 50000	min. 50000	min. 50000	min. 50000	min. 50000	min. 50000	min. 50000	min. 50000	min. 50000	min. 50000

Werkstoffgruppe material group	Ø mm	0,6			0,8				1				
	l3 mm	3	5	8	4	6	8	10	6	10	14	18	24
Graphit & Faserverbund	v _c [m/min]	780	625	470	780	625	545	470	715	545	495	430	390
	f _z [mm]	0,028	0,024	0,015	0,035	0,031	0,028	0,021	0,042	0,032	0,025	0,018	0,013
	v _f [mm/min]	2800	2380	1540	3500	3080	2800	2100	4200	3220	2520	1820	1260
	n [1/min]	min. 50000	min. 50000	min. 50000	min. 50000	min. 50000	min. 50000	min. 50000	min. 50000	min. 50000	min. 50000	min. 50000	min. 50000

Werkstoffgruppe material group	Ø mm	1,2					1,5				
	l3 mm	6	10	14	18	24	6	10	14	18	24
Graphit & Faserverbund	v _c [m/min]	780	625	545	495	430	780	715	625	545	495
	f _z [mm]	0,049	0,042	0,031	0,025	0,017	0,056	0,042	0,036	0,031	0,025
	v _f [mm/min]	4900	4200	3080	2520	1680	5600	4200	3640	3080	2520
	n [1/min]	min. 50000	min. 50000	min. 50000	min. 50000	min. 50000	min. 50000	min. 50000	min. 50000	min. 50000	min. 50000

Werkstoffgruppe material group	Ø mm	2					2,5			
	l3 mm	6	10	14	18	24	30	10	20	30
Graphit & Faserverbund	v _c [m/min]	780	780	715	625	545	495	780	625	545
	f _z [mm]	0,070	0,063	0,056	0,049	0,039	0,028	0,070	0,056	0,039
	v _f [mm/min]	7000	6300	5600	4900	3920	2800	7000	5600	3920
	n [1/min]	min. 50000	min. 50000	min. 50000	min. 50000	min. 50000	min. 50000	min. 50000	min. 50000	min. 50000

Werkstoffgruppe material group	Ø mm	3						4				
	l3 mm	6	10	14	18	24	30	10	14	18	24	30
Graphit & Faserverbund	v _c [m/min]	780	780	780	715	625	545	780	780	780	715	625
	f _z [mm]	0,084	0,070	0,063	0,056	0,049	0,042	0,084	0,077	0,070	0,063	0,056
	v _f [mm/min]	8400	7000	6300	5600	4900	4200	8400	7700	7000	6300	5570
	n [1/min]	min. 50000	min. 50000	min. 50000	min. 50000	min. 50000	min. 50000	min. 50000	min. 50000	min. 50000	min. 50000	min. 50000

Werkstoffgruppe material group	Ø mm	5				6				
	l3 mm	10	20	30	40	12	20	30	40	50
Graphit & Faserverbund	v _c [m/min]	780	780	715	625	780	780	780	715	624
	f _z [mm]	0,112	0,098	0,077	0,053	0,126	0,115	0,098	0,078	0,056
	v _f [mm/min]	11130	9740	7010	4230	10430	9510	8110	5940	3710
	n [1/min]	49700	49700	45500	39800	41400	41400	41400	37900	33100

		▽	▽▽	
	< 4 x D	a _p	0,5 x D	0,5 x D
		a _e	0,1 x D	0,05 x D
	< 8 x D	a _p	0,5 x D	0,5 x D
		a _e	0,1 x D	0,05 x D
	< 12 x D	a _p	0,4 x D	0,4 x D
		a _e	0,1 x D	0,05 x D
> 12 x D	a _p	0,3 x D	0,3 x D	
	a _e	0,1 x D	0,05 x D	

HAM 40-6080 / 6090

Vollhartmetall-Radiusfräser
solid carbide ball nose end mill

W+F VHM Z 2 30° rechts Werk Norm
Typ H HA
HSF HSC SHRINK FIT

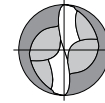
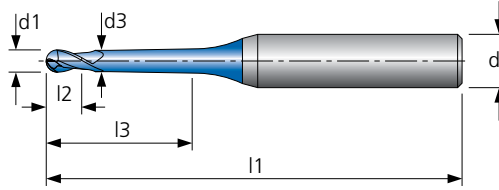

Material	Alu Knet-leg.	Alu Guss-leg.	Stahl < 800 N/mm²	Stahl < 1200 N/mm²	Stahl < 1600 N/mm²	Stahl < 55 HRC	Stahl < 60 HRC	Stahl < 66 HRC	INOX < 800 N/mm²	INOX > 800 N/mm²	GG	GGG	hochw. Legierungen	Titan	NE-Metalle Cu-Leg.	Graphit & Faserverbund	MMS	max.	ohne	AIR
40-6080 / 40-6090			●	●	●	●	●	●	○	○	●	●					●		●	●

● sehr gut geeignet / very suitable ○ bedingt geeignet / limited suitable

HAM 40-6080 / 40-6090

Ø	l3	R	Stahl < 800 N/mm²				Stahl < 1200 N/mm²				Stahl < 1600 N/mm²				Stahl < 60 HRC			
			GG				GGG				Stahl < 55 HRC							
			n [1/min]	fz [mm]	ap	ae	n [1/min]	fz [mm]	ap	ae	n [1/min]	fz [mm]	ap	ae	n [1/min]	fz [mm]	ap	ae
0,2	0,5	0,1	42000	0,022	0,020	0,052	42000	0,022	0,016	0,050	42000	0,020	0,012	0,038	40000	0,016	0,012	0,036
0,2	1	0,1	42000	0,020	0,018	0,047	42000	0,020	0,012	0,047	40000	0,020	0,011	0,030	40000	0,016	0,010	0,025
0,2	1,5	0,1	40000	0,020	0,015	0,044	40000	0,020	0,010	0,042	38000	0,018	0,008	0,025	38000	0,015	0,006	0,020
0,3	1	0,15	42000	0,023	0,019	0,057	42000	0,020	0,017	0,050	42000	0,018	0,013	0,038	42000	0,016	0,013	0,038
0,3	1,5	0,15	42000	0,023	0,015	0,044	40000	0,020	0,013	0,038	40000	0,018	0,012	0,030	38000	0,016	0,011	0,032
0,3	2	0,15	40000	0,020	0,012	0,033	36000	0,018	0,010	0,029	36000	0,018	0,011	0,022	35000	0,015	0,008	0,026
0,4	1	0,2	42000	0,030	0,038	0,092	40000	0,028	0,032	0,100	40000	0,022	0,025	0,075	36000	0,022	0,019	0,060
0,4	1,5	0,2	42000	0,027	0,030	0,089	38000	0,027	0,027	0,080	38000	0,022	0,018	0,062	36000	0,020	0,017	0,047
0,4	2	0,2	40000	0,027	0,030	0,084	38000	0,026	0,020	0,068	38000	0,022	0,014	0,050	36000	0,020	0,012	0,035
0,4	2,5	0,2	40000	0,024	0,018	0,066	35000	0,026	0,016	0,050	35000	0,022	0,010	0,040	34000	0,019	0,010	0,027
0,4	3	0,2	40000	0,024	0,016	0,047	35000	0,025	0,012	0,038	35000	0,022	0,008	0,030	34000	0,019	0,008	0,023
0,5	2	0,25	42000	0,030	0,033	0,100	36000	0,030	0,031	0,095	34000	0,023	0,021	0,076	32000	0,022	0,019	0,072
0,5	3	0,25	40000	0,027	0,028	0,088	32000	0,026	0,026	0,082	30000	0,021	0,018	0,068	28000	0,020	0,017	0,065
0,5	4	0,25	40000	0,025	0,020	0,060	32000	0,023	0,018	0,058	28000	0,021	0,015	0,050	26000	0,020	0,013	0,047
0,5	5	0,25	35000	0,025	0,015	0,055	30000	0,023	0,012	0,050	28000	0,021	0,010	0,040	26000	0,020	0,009	0,038
0,5	6	0,25	35000	0,024	0,010	0,034	28000	0,020	0,010	0,030	25000	0,020	0,008	0,024	24000	0,018	0,008	0,022
0,5	8	0,25	32000	0,022	0,007	0,030	28000	0,017	0,007	0,028	22000	0,016	0,006	0,020	22000	0,015	0,005	0,017
0,6	2	0,3	42000	0,036	0,037	0,086	40000	0,034	0,030	0,080	38000	0,030	0,025	0,075	36000	0,028	0,023	0,072
0,6	3	0,3	40000	0,036	0,030	0,077	38000	0,034	0,030	0,072	36000	0,030	0,025	0,068	34000	0,028	0,023	0,065
0,6	4	0,3	40000	0,030	0,024	0,066	38000	0,028	0,022	0,063	36000	0,025	0,018	0,060	34000	0,023	0,016	0,058
0,6	5	0,3	38000	0,030	0,018	0,058	36000	0,028	0,015	0,055	34000	0,025	0,012	0,052	32000	0,023	0,010	0,050
0,6	6	0,3	35000	0,026	0,014	0,048	34000	0,024	0,011	0,045	32000	0,020	0,009	0,043	30000	0,018	0,007	0,040
0,6	8	0,3	30000	0,026	0,010	0,037	28000	0,024	0,008	0,034	26000	0,020	0,006	0,030	26000	0,018	0,005	0,027
0,8	2	0,4	42000	0,038	0,070	0,200	40000	0,034	0,065	0,190	38000	0,030	0,055	0,150	36000	0,028	0,030	0,090
0,8	4	0,4	42000	0,038	0,060	0,160	40000	0,034	0,050	0,150	38000	0,030	0,045	0,140	36000	0,028	0,022	0,050
0,8	5	0,4	40000	0,032	0,050	0,130	38000	0,029	0,045	0,120	36000	0,027	0,040	0,110	34000	0,025	0,020	0,040
0,8	6	0,4	38000	0,032	0,040	0,100	36000	0,029	0,030	0,090	34000	0,027	0,022	0,086	32000	0,025	0,018	0,032
0,8	7	0,4	36000	0,032	0,026	0,080	34000	0,029	0,026	0,070	32000	0,027	0,022	0,067	30000	0,025	0,012	0,028
0,8	8	0,4	34000	0,032	0,018	0,060	32000	0,029	0,016	0,050	30000	0,027	0,011	0,038	28000	0,025	0,010	0,022
0,8	10	0,4	32000	0,027	0,018	0,060	30000	0,025	0,016	0,050	28000	0,021	0,011	0,038	26000	0,020	0,007	0,018
1	3	0,5	42000	0,045	0,090	0,270	40000	0,042	0,075	0,250	38000	0,035	0,060	0,240	36000	0,034	0,058	0,200
1	4	0,5	40000	0,045	0,060	0,170	38000	0,042	0,060	0,150	36000	0,035	0,055	0,14	34000	0,034	0,052	0,130
1	5	0,5	40000	0,045	0,040	0,150	38000	0,042	0,040	0,120	36000	0,035	0,038	0,111	34000	0,034	0,036	0,100
1	6	0,5	38000	0,040	0,038	0,100	36000	0,037	0,038	0,100	34000	0,032	0,034	0,090	32000	0,030	0,031	0,080
1	7	0,5	38000	0,040	0,038	0,090	36000	0,037	0,038	0,090	34000	0,032	0,034	0,080	32000	0,030	0,031	0,070
1	8	0,5	38000	0,040	0,036	0,090	36000	0,037	0,036	0,090	34000	0,032	0,032	0,080	32000	0,030	0,031	0,070
1	9	0,5	36000	0,040	0,034	0,080	34000	0,037	0,034	0,080	32000	0,032	0,030	0,070	30000	0,030	0,031	0,060
1	10	0,5	36000	0,039	0,023	0,068	34000	0,035	0,023	0,068	32000	0,028	0,022	0,060	30000	0,028	0,020	0,050
1	12	0,5	34000	0,039	0,021	0,068	32000	0,035	0,021	0,068	30000	0,028	0,020	0,060	28000	0,028	0,018	0,050
1	14	0,5	34000	0,039	0,018	0,056	32000	0,035	0,018	0,056	30000	0,028	0,016	0,050	28000	0,028	0,013	0,040
1	16	0,5	30000	0,037	0,014	0,040	28000	0,032	0,014	0,040	26000	0,028	0,012	0,043	24000	0,025	0,010	0,040
1	20	0,5	28000	0,037	0,008	0,025	26000	0,029	0,008	0,025	24000	0,026	0,006	0,019	22000	0,025	0,005	0,017
1,2	6	0,6	32000	0,038	0,040	0,100	30000	0,034	0,035	0,100	28000	0,032	0,031	0,094	26000	0,030	0,029	0,090
1,2	8	0,6	30000	0,038	0,037	0,104	28000	0,034	0,032	0,095	26000	0,032	0,029	0,090	24000	0,030	0,026	0,083
1,2	10	0,6	30000	0,038	0,032	0,090	28000	0,034	0,029	0,090	26000	0,032	0,024	0,086	24000	0,030	0,021	0,080
1,2	12	0,6	28000	0,038	0,030	0,086	26000	0,034	0,025	0,080	24000	0,030	0,021	0,077	24000	0,028	0,018	0,070
1,4	8	0,7	30000	0,038	0,037	0,104	28000	0,034	0,032	0,095	26000	0,032	0,029	0,090	24000	0,030	0,026	0,083
1,4	12	0,7	30000	0,038	0,032	0,090	28000	0,034	0,029	0,090	26000	0,032	0,024	0,086	24000	0,030	0,021	0,080
1,4	16	0,7	30000	0,038	0,029	0,080	28000	0,032	0,026	0,070	26000	0,030	0,020	0,082	24000	0,028	0,017	0,060

HAM 40-6080 / 40-6090

Ø	l3	R	Stahl < 800 N/mm ²				Stahl < 1200 N/mm ²				Stahl < 1600 N/mm ²				Stahl < 60 HRC			
			GG				GGG				Stahl < 55 HRC							
			n [1/min]	fz [mm]	ap	ae	n [1/min]	fz [mm]	ap	ae	n [1/min]	fz [mm]	ap	ae	INOX < 800 N/mm ²	INOX > 800 N/mm ²	n [1/min]	fz [mm]
1,5	8	0,75	26000	0,043	0,040	0,130	24000	0,040	0,037	0,120	20000	0,037	0,034	0,110	20000	0,035	0,030	0,100
1,5	12	0,75	26000	0,040	0,040	0,130	24000	0,038	0,037	0,120	20000	0,034	0,034	0,110	20000	0,032	0,030	0,100
1,5	16	0,75	24000	0,035	0,031	0,100	22000	0,032	0,030	0,090	20000	0,031	0,027	0,085	18000	0,029	0,022	0,080
1,5	20	0,75	22000	0,032	0,027	0,100	20000	0,030	0,024	0,090	18000	0,029	0,022	0,085	16000	0,027	0,019	0,080
1,6	8	0,8	28000	0,050	0,100	0,200	26000	0,048	0,096	0,180	26000	0,040	0,070	0,180	25000	0,037	0,066	0,170
1,6	12	0,8	26000	0,045	0,060	0,180	24000	0,042	0,055	0,160	24000	0,038	0,040	0,160	24000	0,035	0,036	0,150
1,6	16	0,8	24000	0,040	0,040	0,140	22000	0,037	0,036	0,120	22000	0,034	0,027	0,120	22000	0,031	0,024	0,110
1,6	20	0,8	22000	0,040	0,040	0,120	20000	0,035	0,035	0,100	20000	0,032	0,023	0,100	20000	0,029	0,022	0,090
1,8	8	0,8	28000	0,050	0,100	0,200	26000	0,048	0,096	0,180	26000	0,040	0,070	0,180	25000	0,037	0,066	0,170
1,8	12	0,8	26000	0,045	0,060	0,180	24000	0,042	0,055	0,160	24000	0,038	0,040	0,160	24000	0,035	0,036	0,150
1,8	16	0,8	24000	0,040	0,040	0,140	22000	0,037	0,036	0,120	22000	0,034	0,027	0,120	22000	0,031	0,024	0,110
1,8	20	0,8	22000	0,040	0,040	0,120	20000	0,035	0,035	0,100	20000	0,032	0,023	0,100	20000	0,029	0,022	0,090
2	6	1	26000	0,072	0,200	0,400	24000	0,070	0,160	0,350	21000	0,060	0,120	0,300	18000	0,055	0,110	0,250
2	8	1	26000	0,072	0,140	0,300	24000	0,070	0,100	0,250	21000	0,060	0,080	0,200	18000	0,055	0,075	0,170
2	10	1	24000	0,072	0,140	0,300	22000	0,070	0,100	0,250	18000	0,060	0,080	0,200	16000	0,055	0,075	0,170
2	12	1	24000	0,066	0,080	0,200	22000	0,064	0,070	0,170	18000	0,058	0,050	0,120	16000	0,052	0,048	0,100
2	14	1	22000	0,066	0,080	0,200	20000	0,064	0,070	0,170	18000	0,058	0,050	0,120	16000	0,052	0,048	0,100
2	16	1	22000	0,066	0,080	0,200	20000	0,064	0,070	0,170	16000	0,058	0,050	0,120	14000	0,052	0,048	0,100
2	18	1	20000	0,066	0,050	0,200	18000	0,064	0,040	0,170	16000	0,058	0,030	0,120	14000	0,052	0,028	0,100
2	20	1	20000	0,066	0,050	0,150	18000	0,064	0,040	0,120	14000	0,058	0,030	0,100	12000	0,052	0,028	0,080
2	22	1	18000	0,060	0,050	0,150	16000	0,058	0,040	0,120	14000	0,052	0,030	0,100	12000	0,045	0,028	0,080
2	25	1	18000	0,060	0,050	0,100	16000	0,058	0,040	0,090	12000	0,052	0,030	0,080	10000	0,045	0,028	0,070
2	30	1	16000	0,060	0,030	0,100	14000	0,058	0,025	0,090	12000	0,052	0,020	0,080	10000	0,045	0,018	0,070
3	8	1,5	18000	0,087	0,180	0,300	15000	0,075	0,160	0,300	14000	0,070	0,130	0,300	12000	0,060	0,110	0,250
3	10	1,5	18000	0,087	0,180	0,300	15000	0,075	0,160	0,300	14000	0,070	0,130	0,300	12000	0,060	0,110	0,250
3	16	1,5	16000	0,077	0,120	0,250	13000	0,070	0,090	0,250	10000	0,065	0,110	0,250	8000	0,055	0,090	0,220
3	20	1,5	16000	0,077	0,080	0,200	12000	0,070	0,090	0,200	10000	0,065	0,060	0,200	8000	0,055	0,055	0,170
3	25	1,5	16000	0,077	0,080	0,200	12000	0,060	0,066	0,150	8000	0,055	0,060	0,150	6000	0,045	0,055	0,120
3	30	1,5	14000	0,067	0,080	0,200	10000	0,060	0,066	0,150	8000	0,055	0,050	0,150	6000	0,045	0,046	0,120
3	35	1,5	14000	0,067	0,080	0,200	10000	0,051	0,055	0,150	8000	0,045	0,050	0,150	6000	0,036	0,046	0,120
4	10	2	13000	0,100	0,350	0,300	12000	0,090	0,300	0,300	11000	0,080	0,250	0,300	10000	0,075	0,220	0,300
4	16	2	13000	0,100	0,250	0,250	11000	0,090	0,200	0,250	10000	0,080	0,170	0,250	9000	0,075	0,150	0,250
4	20	2	11000	0,090	0,200	0,250	11000	0,080	0,150	0,250	10000	0,070	0,120	0,250	9000	0,066	0,110	0,250
4	25	2	11000	0,090	0,140	0,250	10000	0,080	0,100	0,250	9000	0,070	0,090	0,250	8000	0,066	0,080	0,250
4	30	2	11000	0,090	0,090	0,200	10000	0,080	0,080	0,200	9000	0,070	0,070	0,200	8000	0,066	0,060	0,200
4	35	2	11000	0,090	0,090	0,200	10000	0,080	0,080	0,200	9000	0,070	0,070	0,200	8000	0,066	0,060	0,200
4	40	2	10000	0,080	0,080	0,200	9000	0,070	0,070	0,200	8000	0,065	0,065	0,200	7000	0,060	0,058	0,200
4	45	2	10000	0,080	0,080	0,200	9000	0,070	0,070	0,200	8000	0,065	0,065	0,200	7000	0,060	0,058	0,200
4	50	2	10000	0,080	0,080	0,200	9000	0,070	0,070	0,200	8000	0,065	0,065	0,200	7000	0,060	0,058	0,200
5	20	2,5	11000	0,110	0,300	0,300	10000	0,110	0,260	0,300	9000	0,100	0,220	0,300	8000	0,090	0,200	0,300
5	25	2,5	11000	0,110	0,300	0,300	10000	0,110	0,260	0,300	9000	0,100	0,220	0,300	8000	0,090	0,200	0,300
5	30	2,5	11000	0,110	0,250	0,300	10000	0,110	0,200	0,300	9000	0,100	0,160	0,300	8000	0,090	0,140	0,300
5	35	2,5	9000	0,110	0,200	0,250	8000	0,100	0,160	0,250	7000	0,090	0,140	0,250	6000	0,090	0,130	0,250
6	30	3	10000	0,120	0,350	0,350	9000	0,110	0,310	0,350	8000	0,100	0,260	0,350	7000	0,090	0,220	0,350
6	50	3	9000	0,110	0,120	0,300	8000	0,100	0,110	0,300	7000	0,090	0,090	0,300	6000	0,090	0,080	0,300

HAM 40-5670 / 5710

Vollhartmetall-Radiusfräser
solid carbide ball nose end mill

W+F VHM Z 2 30° rechts Werk Norm
Typ N DIN 6535 HA
SHRINK FIT DIN 6535 HB

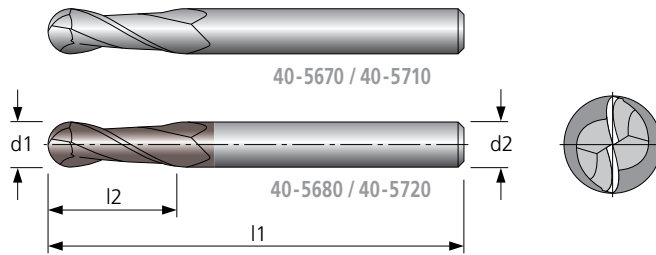

Material	Alu Knet-leg.	Alu Guss-leg.	Stahl < 800 N/mm²	Stahl < 1200 N/mm²	Stahl < 1600 N/mm²	Stahl < 55 HRC	Stahl < 60 HRC	Stahl < 66 HRC	INOX < 800 N/mm²	INOX > 800 N/mm²	GG	GGG	hochw. Legierungen	Titan	NE-Metalle Cu-Leg.	Graphit & Faser-verbund	MMS	max.	ohne	AIR
40-5670 / 40-5710	○	○	●	○	○	○			○	○	●	○			○		●	○	○	●
40-5680 / 40-5720			●	●	●	○			○	○	●	●					●	○	○	●

● sehr gut geeignet / very suitable ○ bedingt geeignet / limited suitable

HAM 40-5670* / 40-5680 / 40-5710* / 40-5720

* unbeschichtete Werkzeuge HAM 40-5670 / 40-5710: $v_c \times 0,5$ (ca.)
* uncoated tools HAM 40-5670 / 40-5710: $v_c \times 0,5$ (ca.)

Werkstoffgruppe material group	Ø mm	0,5	1	2	4	6	8	10	12	14	16	18	20
Alu Knetlegierungen	v_c [m/min]	500	500	500	500	500	500	500	500	500	500	500	500
	f_z [mm]	0,015	0,030	0,050	0,080	0,100	0,150	0,200	0,230	0,250	0,280	0,300	0,350
	v_f [mm/min]	1500	3000	5000	6370	5300	5970	6360	6120	5700	5540	5280	5600
	n [1/min]	min. 50000	min. 50000	min. 50000	39800	26500	19900	15900	13300	11400	9900	8800	8000
Alu Gusslegierungen	v_c [m/min]	400	400	400	400	400	400	400	400	400	400	400	400
	f_z [mm]	0,015	0,030	0,050	0,080	0,100	0,150	0,200	0,230	0,250	0,280	0,300	0,350
	v_f [mm/min]	1500	3000	5000	5090	4240	4770	5080	4880	4550	4480	4260	4480
	n [1/min]	min. 50000	min. 50000	min. 50000	31800	21200	15900	12700	10600	9100	8000	7100	6400
Stahl < 800 N/mm²	v_c [m/min]	300	300	300	300	300	300	300	300	300	300	300	300
	f_z [mm]	0,010	0,014	0,022	0,057	0,100	0,120	0,130	0,150	0,180	0,210	0,260	0,260
	v_f [mm/min]	1000	1400	2100	2720	3180	2860	2470	2400	2450	2520	2760	2500
	n [1/min]	min. 50000	min. 50000	47700	23900	15900	11900	9500	8000	6800	6000	5300	4800
Stahl < 1200 N/mm²	v_c [m/min]	250	250	250	250	250	250	250	250	250	250	250	250
	f_z [mm]	0,010	0,015	0,020	0,050	0,100	0,110	0,120	0,140	0,160	0,190	0,240	0,240
	v_f [mm/min]	1000	1500	1590	1990	2660	2180	1920	1850	1820	1900	2110	1920
	n [1/min]	min. 50000	min. 50000	39800	19900	13300	9900	8000	6600	5700	5000	4400	4000
Stahl < 1600 N/mm²	v_c [m/min]	210	210	210	210	210	210	210	210	210	210	210	210
	f_z [mm]	0,010	0,010	0,020	0,040	0,080	0,100	0,100	0,120	0,140	0,160	0,200	0,200
	v_f [mm/min]	1000	1000	1340	1340	1780	1680	1340	1340	1340	1340	1480	1320
	n [1/min]	min. 50000	min. 50000	33400	16700	11100	8400	6700	5600	4800	4200	3700	3300
Stahl < 55 HRC	v_c [m/min]	150	150	150	150	150	150	150	150	150	150	150	150
	f_z [mm]	0,006	0,010	0,015	0,035	0,060	0,075	0,080	0,095	0,110	0,130	0,160	0,160
	v_f [mm/min]	600	950	720	830	960	900	770	760	750	780	860	770
	n [1/min]	min. 50000	47700	23900	11900	8000	6000	4800	4000	3400	3000	2700	2400
INOX < 800 N/mm²	v_c [m/min]	115	115	115	115	115	115	115	115	115	115	115	115
	f_z [mm]	0,007	0,010	0,015	0,040	0,070	0,090	0,095	0,110	0,130	0,150	0,190	0,190
	v_f [mm/min]	700	730	550	740	850	830	700	680	680	690	760	680
	n [1/min]	min. 50000	36600	18300	9200	6100	4600	3700	3100	2600	2300	2000	1800
INOX > 800 N/mm²	v_c [m/min]	80	80	80	80	80	80	80	80	80	80	80	80
	f_z [mm]	0,005	0,010	0,015	0,035	0,060	0,075	0,080	0,095	0,110	0,130	0,160	0,160
	v_f [mm/min]	500	510	380	450	500	480	400	400	400	420	450	420
	n [1/min]	min. 50000	25500	12700	6400	4200	3200	2500	2100	1800	1600	1400	1300
GG	v_c [m/min]	290	290	290	290	290	290	290	290	290	290	290	290
	f_z [mm]	0,010	0,015	0,020	0,060	0,100	0,120	0,130	0,150	0,180	0,210	0,260	0,260
	v_f [mm/min]	1000	1500	1850	2770	3080	2760	2390	2310	2380	2440	2650	2390
	n [1/min]	min. 50000	min. 50000	46200	23100	15400	11500	9200	7700	6600	5800	5100	4600
GGG	v_c [m/min]	250	250	250	250	250	250	250	250	250	250	250	250
	f_z [mm]	0,010	0,015	0,020	0,050	0,090	0,110	0,120	0,140	0,160	0,190	0,240	0,240
	v_f [mm/min]	1000	1500	1590	1990	2390	2180	1920	1850	1820	1900	2110	1920
	n [1/min]	min. 50000	min. 50000	39800	19900	13300	9900	8000	6600	5700	5000	4400	4000
NE-Metalle Cu-Legierungen	v_c [m/min]	320	320	320	320	320	320	320	320	320	320	320	320
	f_z [mm]	0,015	0,030	0,050	0,080	0,100	0,150	0,200	0,230	0,250	0,280	0,300	0,350
	v_f [mm/min]	1500	3000	5000	4080	3400	3810	4080	3910	3650	3580	3420	3570
	n [1/min]	min. 50000	min. 50000	min. 50000	25500	17000	12700	10200	8500	7300	6400	5700	5100

	Alu Knet-leg.	Alu Guss-leg.	Stahl < 800 N/mm²	Stahl < 1200 N/mm²	Stahl < 1600 N/mm²	Stahl < 55 HRC	INOX < 800 N/mm²	INOX > 800 N/mm²	GG	GGG	NE-Metalle Cu-Leg.
a_p	0,1 x D	0,1 x D	0,07 x D	0,05 x D	0,05 x D	0,05 x D	0,05 x D	0,05 x D	0,05 x D	0,05 x D	0,1 x D
a_e	0,1 x D	0,1 x D	0,05 x D	0,05 x D	0,05 x D	0,05 x D	0,05 x D	0,05 x D	0,05 x D	0,05 x D	0,1 x D

HAM 40-5760

Vollhartmetall-Radiusfräser solid carbide ball nose end mill

W+F VHM Z 2 30° rechts Werk Norm
Typ H DIN 6535 HA
HSC SHRINK FIT
DIN 6535 HB

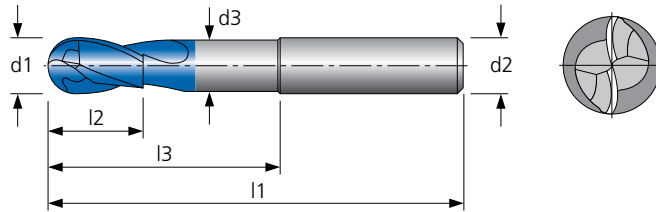

Material	Alu Knet-leg.	Alu Guss-leg.	Stahl < 800 N/mm²	Stahl < 1200 N/mm²	Stahl < 1600 N/mm²	Stahl < 55 HRC	Stahl < 60 HRC	Stahl < 66 HRC	INOX < 800 N/mm²	INOX > 800 N/mm²	GG	GGG	hochw. Legierungen	Titan	NE-Metalle Cu-Leg.	Graphit & Faser-verbund	MMS	max.	ohne	AIR	
40-5760			○	●	●	●	●	○	○	○	○	●	●	○	○			●	○	●	●

● sehr gut geeignet / very suitable ○ bedingt geeignet / limited suitable

HAM 40-5760

Werkstoffgruppe material group	Ø mm	0,5	0,8	1	2	3	4	5	6	8	10	12	16
Stahl < 800 N/mm²	V _c [m/min]	140	140	140	140	140	140	140	140	140	140	140	140
	f _z [mm]	0,003	0,005	0,006	0,012	0,020	0,025	0,025	0,030	0,040	0,060	0,070	0,085
	V _f [mm/min]	300	500	540	540	600	560	450	440	450	540	520	480
	n [1/min]	min. 50000	min. 50000	44600	22300	14900	11100	8900	7400	5600	4500	3700	2800
Stahl < 1200 N/mm²	V _c [m/min]	110	110	110	110	110	110	110	110	110	110	110	110
	f _z [mm]	0,003	0,005	0,006	0,012	0,020	0,025	0,025	0,030	0,040	0,060	0,070	0,085
	V _f [mm/min]	300	440	420	420	470	440	350	350	350	420	410	370
	n [1/min]	min. 50000	43800	35000	17500	11700	8800	7000	5800	4400	3500	2900	2200
Stahl < 1600 N/mm²	V _c [m/min]	90	90	90	90	90	90	90	90	90	90	90	90
	f _z [mm]	0,002	0,003	0,004	0,008	0,015	0,020	0,022	0,025	0,035	0,042	0,050	0,060
	V _f [mm/min]	200	210	230	230	290	290	250	240	250	240	240	220
	n [1/min]	min. 50000	35800	28600	14300	9500	7200	5700	4800	3600	2900	2400	1800
Stahl < 55 HRC	V _c [m/min]	80	80	80	80	80	80	80	80	80	80	80	80
	f _z [mm]	0,002	0,002	0,003	0,006	0,013	0,017	0,020	0,025	0,030	0,045	0,050	0,060
	V _f [mm/min]	200	130	150	150	220	220	200	210	190	230	210	190
	n [1/min]	min. 50000	31800	25500	12700	8500	6400	5100	4200	3200	2500	2100	1600
Stahl < 60 HRC	V _c [m/min]	60	60	60	60	60	60	60	60	60	60	60	60
	f _z [mm]	0,001	0,002	0,003	0,006	0,012	0,015	0,018	0,020	0,025	0,035	0,045	0,055
	V _f [mm/min]	80	100	110	110	150	140	140	130	120	130	140	130
	n [1/min]	38200	23900	19100	9500	6400	4800	3800	3200	2400	1900	1600	1200
Stahl < 66 HRC	V _c [m/min]	40	40	40	40	40	40	40	40	40	40	40	40
	f _z [mm]	0,001	0,002	0,003	0,006	0,010	0,012	0,015	0,018	0,025	0,035	0,040	0,050
	V _f [mm/min]	50	60	80	80	80	80	80	80	80	90	90	80
	n [1/min]	25500	15900	12700	6400	4200	3200	2500	2100	1600	1300	1100	800
INOX < 800 N/mm²	V _c [m/min]	80	80	80	80	80	80	80	80	80	80	80	80
	f _z [mm]	0,002	0,004	0,005	0,010	0,015	0,020	0,022	0,025	0,035	0,042	0,050	0,060
	V _f [mm/min]	200	250	260	250	260	260	220	210	220	210	210	190
	n [1/min]	min. 50000	31800	25500	12700	8500	6400	5100	4200	3200	2500	2100	1600
INOX > 800 N/mm²	V _c [m/min]	50	50	50	50	50	50	50	50	50	50	50	50
	f _z [mm]	0,002	0,003	0,004	0,008	0,012	0,018	0,020	0,022	0,028	0,040	0,048	0,058
	V _f [mm/min]	130	130	130	130	130	140	130	120	110	130	120	120
	n [1/min]	31800	19900	15900	8000	5300	4000	3200	2700	2000	1600	1300	1000
GG	V _c [m/min]	140	140	140	140	140	140	140	140	140	140	140	140
	f _z [mm]	0,004	0,005	0,006	0,010	0,018	0,020	0,025	0,028	0,040	0,055	0,060	0,080
	V _f [mm/min]	400	500	540	450	540	440	450	410	450	500	440	450
	n [1/min]	min. 50000	min. 50000	44600	22300	14900	11100	8900	7400	5600	4500	3700	2800
GGG	V _c [m/min]	110	110	110	110	110	110	110	110	110	110	110	110
	f _z [mm]	0,003	0,004	0,005	0,008	0,015	0,018	0,020	0,025	0,035	0,050	0,060	0,075
	V _f [mm/min]	300	350	350	280	350	320	280	290	310	350	350	330
	n [1/min]	min. 50000	43800	35000	17500	11700	8800	7000	5800	4400	3500	2900	2200
hochwärmfeste Legierungen	V _c [m/min]	35	35	35	35	35	35	35	35	35	35	35	35
	f _z [mm]	0,003	0,005	0,005	0,010	0,015	0,020	0,025	0,030	0,040	0,050	0,060	0,080
	V _f [mm/min]	130	140	110	110	110	110	110	110	110	110	110	110
	n [1/min]	22300	13900	11100	5600	3700	2800	2200	1900	1400	1100	900	700
Titan	V _c [m/min]	60	60	60	60	60	60	60	60	60	60	60	60
	f _z [mm]	0,003	0,005	0,005	0,010	0,015	0,020	0,025	0,030	0,040	0,050	0,060	0,080
	V _f [mm/min]	230	240	190	190	190	190	190	190	190	190	190	190
	n [1/min]	38200	23900	19100	9500	6400	4800	3800	3200	2400	1900	1600	1200

Auskraglänge projection length		Stahl < 800 N/mm ²	Stahl < 1200 N/mm ²	Stahl < 1600 N/mm ²	Stahl < 55 HRC	Stahl < 60 HRC	Stahl < 66 HRC
< 4 x D	a _p	0,08 x D	0,08 x D	0,05 x D	0,05 x D	0,03 x D	0,03 x D
	a _e	1 x D	1 x D	1 x D	1 x D	1 x D	1 x D
	v _c	x 1	x 1	x 1	x 1	x 1	x 1
	f _z	x 1	x 1	x 1	x 1	x 1	x 1
< 8 x D	a _p	0,08 x D	0,08 x D	0,05 x D	0,05 x D	0,03 x D	0,03 x D
	a _e	1 x D	1 x D	1 x D	1 x D	1 x D	1 x D
	v _c	x 0,9	x 0,9	x 0,9	x 0,9	x 0,9	x 0,9
	f _z	x 0,8	x 0,8	x 0,8	x 0,8	x 0,8	x 0,8
> 8 x D	a _p	0,08 x D	0,08 x D	0,05 x D	0,05 x D	0,03 x D	0,03 x D
	a _e	1 x D	1 x D	1 x D	1 x D	1 x D	1 x D
	v _c	x 0,8	x 0,8	x 0,8	x 0,8	x 0,8	x 0,8
	f _z	x 0,6	x 0,6	x 0,6	x 0,6	x 0,6	x 0,6

Auskraglänge projection length		INOX < 800 N/mm ²	INOX > 800 N/mm ²	GG	GGG	hochw. Legie- rungen	Titan
< 4 x D	a _p	0,08 x D	0,05 x D	0,08 x D	0,05 x D	0,05 x D	0,05 x D
	a _e	1 x D	1 x D	1 x D	1 x D	1 x D	1 x D
	v _c	x 1	x 1	x 1	x 1	x 1	x 1
	f _z	x 1	x 1	x 1	x 1	x 1	x 1
< 8 x D	a _p	0,08 x D	0,05 x D	0,08 x D	0,05 x D	0,05 x D	0,05 x D
	a _e	1 x D	1 x D	1 x D	1 x D	1 x D	1 x D
	v _c	x 0,9	x 0,9	x 0,9	x 0,9	x 0,9	x 0,9
	f _z	x 0,8	x 0,8	x 0,8	x 0,8	x 0,8	x 0,8
> 8 x D	a _p	0,08 x D	0,05 x D	0,08 x D	0,05 x D	0,05 x D	0,05 x D
	a _e	1 x D	1 x D	1 x D	1 x D	1 x D	1 x D
	v _c	x 0,8	x 0,8	x 0,8	x 0,8	x 0,8	x 0,8
	f _z	x 0,6	x 0,6	x 0,6	x 0,6	x 0,6	x 0,6

HAM 40-5920

Vollhartmetall-Radiuskopierfräser solid carbide ball nose end mill

W+F VHM Z 3 30° rechts Werk Norm
Typ H HA
SHRINK FIT
HB

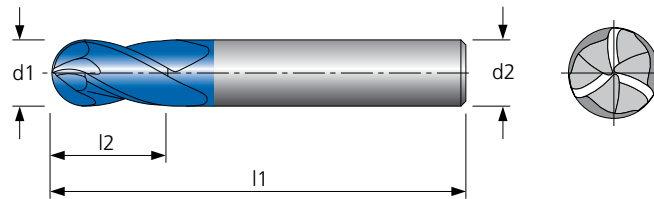

Material	Alu Knet-leg.	Alu Guss-leg.	Stahl < 800 N/mm²	Stahl < 1200 N/mm²	Stahl < 1600 N/mm²	Stahl < 55 HRC	Stahl < 60 HRC	Stahl < 66 HRC	INOX < 800 N/mm²	INOX > 800 N/mm²	GG	GGG	hochw. Legierungen	Titan	NE-Metalle Cu-Leg.	Graphit & Faser-verbund	MMS	max.	ohne	AIR
40-5920					○	●	●	●			●	●					●	○	●	●

● sehr gut geeignet / very suitable ○ bedingt geeignet / limited suitable

HAM 40-5920

Werkstoffgruppe material group	Ø mm	2	3	4	5	6	8	10	12	16	20
Stahl < 1600 N/mm²	v _c [m/min]	300	300	300	300	300	300	300	300	300	300
	f _z [mm]	0,040	0,050	0,065	0,080	0,095	0,110	0,130	0,140	0,150	0,160
	v _f [mm/min]	5720	4770	4660	4580	4530	3930	3710	3360	2700	2300
	n [1/min]	47700	31800	23900	19100	15900	11900	9500	8000	6000	4800
Stahl < 55 HRC	v _c [m/min]	210	210	210	210	210	210	210	210	210	210
	f _z [mm]	0,032	0,039	0,051	0,063	0,075	0,087	0,102	0,110	0,118	0,126
	v _f [mm/min]	3160	2640	2570	2530	2490	2180	2060	1850	1490	1250
	n [1/min]	33400	22300	16700	13400	11100	8400	6700	5600	4200	3300
Stahl < 60 HRC	v _c [m/min]	175	175	175	175	175	175	175	175	175	175
	f _z [mm]	0,029	0,036	0,047	0,058	0,069	0,080	0,095	0,102	0,109	0,117
	v _f [mm/min]	2440	2040	1980	1940	1930	1680	1590	1410	1150	980
	n [1/min]	27900	18600	13900	11100	9300	7000	5600	4600	3500	2800
Stahl < 66 HRC	v _c [m/min]	140	140	140	140	140	140	140	140	140	140
	f _z [mm]	0,026	0,032	0,042	0,052	0,061	0,071	0,084	0,091	0,097	0,104
	v _f [mm/min]	1730	1450	1400	1380	1360	1200	1140	1010	820	680
	n [1/min]	22300	14900	11100	8900	7400	5600	4500	3700	2800	2200
GG	v _c [m/min]	385	385	385	385	385	385	385	385	385	385
	f _z [mm]	0,052	0,065	0,084	0,104	0,123	0,142	0,168	0,181	0,194	0,207
	v _f [mm/min]	7760	7920	7720	7610	7520	6530	6210	5540	4480	3790
	n [1/min]	min. 50000	40800	30600	24500	20400	15300	12300	10200	7700	6100
GGG	v _c [m/min]	350	350	350	350	350	350	350	350	350	350
	f _z [mm]	0,047	0,059	0,076	0,094	0,112	0,129	0,153	0,165	0,176	0,188
	v _f [mm/min]	7060	6550	6400	6300	6240	5400	5090	4600	3710	3160
	n [1/min]	min. 50000	37100	27900	22300	18600	13900	11100	9300	7000	5600

Auskräglänge projection length		Stahl < 1600 N/mm²	Stahl < 55 HRC	Stahl < 60 HRC	Stahl < 66 HRC	GG	GGG
< 4 x D	a _p	0,02 x D	0,02 x D	0,02 x D	0,02 x D	0,02 x D	0,02 x D
	ä _e	0,05 x D	0,05 x D	0,05 x D	0,05 x D	0,05 x D	0,05 x D
	v _c	x 1	x 1	x 1	x 1	x 1	x 1
	f _z	x 1	x 1	x 1	x 1	x 1	x 1
< 8 x D	a _p	0,02 x D	0,02 x D	0,02 x D	0,02 x D	0,02 x D	0,02 x D
	ä _e	0,05 x D	0,05 x D	0,05 x D	0,05 x D	0,05 x D	0,05 x D
	v _c	x 0,85	x 0,85	x 0,85	x 0,85	x 0,85	x 0,85
	f _z	x 0,8	x 0,8	x 0,8	x 0,8	x 0,8	x 0,8
< 10 x D	a _p	0,02 x D	0,02 x D	0,02 x D	0,02 x D	0,02 x D	0,02 x D
	ä _e	0,05 x D	0,05 x D	0,05 x D	0,05 x D	0,05 x D	0,05 x D
	v _c	x 0,8	x 0,8	x 0,8	x 0,8	x 0,8	x 0,8
	f _z	x 0,7	x 0,7	x 0,7	x 0,7	x 0,7	x 0,7
> 10 x D	a _p	0,02 x D	0,02 x D	0,02 x D	0,02 x D	0,02 x D	0,02 x D
	ä _e	0,05 x D	0,05 x D	0,05 x D	0,05 x D	0,05 x D	0,05 x D
	v _c	x 0,7	x 0,7	x 0,7	x 0,7	x 0,7	x 0,7
	f _z	x 0,6	x 0,6	x 0,6	x 0,6	x 0,6	x 0,6

HAM 40-5981

Vollhartmetall-Radiuskopierfräser
solid carbide ball nose end mill

W+F VHM Z 4 30° rechts Werk Norm
Typ H DIN 6535 HA
HSC SHRINK FIT
DIN 6535 HB

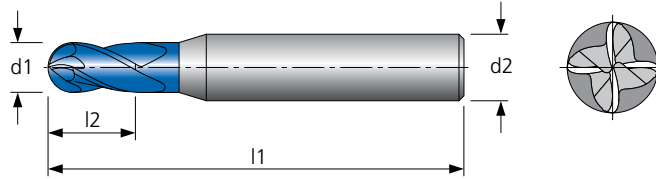

Material	Alu Knet-leg.	Alu Guss-leg.	Stahl < 800 N/mm²	Stahl < 1200 N/mm²	Stahl < 1600 N/mm²	Stahl < 55 HRC	Stahl < 60 HRC	Stahl < 66 HRC	INOX < 800 N/mm²	INOX > 800 N/mm²	GG	GGG	hochw. Legierungen	Titan	NE-Metalle Cu-Leg.	Graphit & Faser-verbund	MMS	max.	ohne	AIR
40-5981			●	●	●	●	○		○	○	●	●					●	○	●	●

● sehr gut geeignet / very suitable ○ bedingt geeignet / limited suitable

HAM 40-5981

Werkstoffgruppe material group	Ø mm	3	4	5	6	8	10	12	14	16	20
Stahl < 800 N/mm²	v_c [m/min]	335	335	335	335	335	335	335	335	335	335
	f_z [mm]	0,050	0,061	0,077	0,094	0,110	0,132	0,165	0,165	0,187	0,187
	v_f [mm/min]	7030	6460	6560	6660	5850	5650	5870	5020	5010	3960
	n [1/min]	35500	26700	21300	17800	13300	10700	8900	7600	6700	5300
Stahl < 1200 N/mm²	v_c [m/min]	280	280	280	280	280	280	280	280	280	280
	f_z [mm]	0,045	0,055	0,070	0,085	0,100	0,120	0,150	0,150	0,170	0,170
	v_f [mm/min]	5350	4910	4980	5070	4440	4270	4440	3840	3810	3060
	n [1/min]	29700	22300	17800	14900	11100	8900	7400	6400	5600	4500
Stahl < 1600 N/mm²	v_c [m/min]	240	240	240	240	240	240	240	240	240	240
	f_z [mm]	0,038	0,047	0,060	0,072	0,085	0,102	0,128	0,128	0,145	0,145
	v_f [mm/min]	3900	3570	3640	3670	3230	3100	3260	2810	2770	2200
	n [1/min]	25500	19100	15300	12700	9500	7600	6400	5500	4800	3800
Stahl < 55 HRC	v_c [m/min]	170	170	170	170	170	170	170	170	170	170
	f_z [mm]	0,030	0,040	0,050	0,060	0,070	0,080	0,100	0,100	0,120	0,130
	v_f [mm/min]	2170	2160	2160	2160	1900	1740	1800	1560	1630	1400
	n [1/min]	18000	13500	10800	9000	6800	5400	4500	3900	3400	2700
Stahl < 60 HRC	v_c [m/min]	130	130	130	130	130	130	130	130	130	130
	f_z [mm]	0,025	0,030	0,040	0,050	0,060	0,070	0,085	0,090	0,095	0,100
	v_f [mm/min]	1380	1240	1320	1380	1250	1150	1160	1080	990	840
	n [1/min]	13800	10300	8300	6900	5200	4100	3400	3000	2600	2100
INOX < 800 N/mm²	v_c [m/min]	180	180	180	180	180	180	180	180	180	180
	f_z [mm]	0,036	0,044	0,056	0,068	0,080	0,096	0,120	0,120	0,136	0,136
	v_f [mm/min]	2750	2520	2580	2580	2300	2190	2300	1970	1960	1580
	n [1/min]	19100	14300	11500	9500	7200	5700	4800	4100	3600	2900
INOX > 800 N/mm²	v_c [m/min]	125	125	125	125	125	125	125	125	125	125
	f_z [mm]	0,030	0,037	0,047	0,057	0,067	0,080	0,101	0,101	0,114	0,114
	v_f [mm/min]	1600	1460	1500	1500	1340	1290	1330	1130	1140	910
	n [1/min]	13300	9900	8000	6600	5000	4000	3300	2800	2500	2000
GG	v_c [m/min]	320	320	320	320	320	320	320	320	320	320
	f_z [mm]	0,050	0,061	0,077	0,094	0,110	0,132	0,165	0,165	0,187	0,187
	v_f [mm/min]	6730	6170	6280	6360	5590	5390	5610	4820	4790	3810
	n [1/min]	34000	25500	20400	17000	12700	10200	8500	7300	6400	5100
GGG	v_c [m/min]	280	280	280	280	280	280	280	280	280	280
	f_z [mm]	0,045	0,055	0,070	0,085	0,100	0,120	0,150	0,150	0,170	0,170
	v_f [mm/min]	5350	4910	4980	5070	4440	4270	4440	3840	3810	3060
	n [1/min]	29700	22300	17800	14900	11100	8900	7400	6400	5600	4500

Ausraglänge projection length		Stahl < 800 N/mm²	Stahl < 1200 N/mm²	Stahl < 1600 N/mm²	Stahl < 55 HRC	Stahl < 60 HRC	INOX < 800 N/mm²	INOX > 800 N/mm²	GG	GGG
< 3 x D	a_p	1 x D	1 x D	0,8 x D	0,7 x D	0,7 x D	0,8 x D	0,8 x D	1 x D	1 x D
	a_e	0,3 x D	0,3 x D	0,3 x D	0,3 x D	0,3 x D	0,3 x D	0,3 x D	0,3 x D	0,3 x D
	v_c	x 1	x 1	x 1	x 1	x 1	x 1	x 1	x 1	x 1
	f_z	x 1	x 1	x 1	x 1	x 1	x 1	x 1	x 1	x 1
> 3 x D	a_p	1 x D	1 x D	0,8 x D	0,7 x D	0,7 x D	0,8 x D	0,8 x D	1 x D	1 x D
	a_e	0,3 x D	0,3 x D	0,3 x D	0,3 x D	0,3 x D	0,3 x D	0,3 x D	0,3 x D	0,3 x D
	v_c	x 0,8	x 0,8	x 0,8	x 0,8	x 0,8	x 0,8	x 0,8	x 0,8	x 0,8
	f_z	x 0,8	x 0,8	x 0,8	x 0,8	x 0,8	x 0,8	x 0,8	x 0,8	x 0,8

HAM 40-5800

Vollhartmetall-Radiusfräser solid carbide ball nose end mill

W+F VHM Z 2 15° rechts Werk Norm
Typ H HA
HSF HSC SHRINK FIT
HB

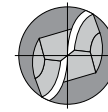
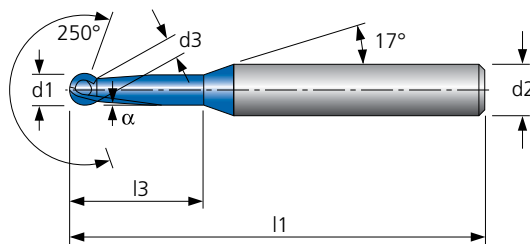

Material	Alu Knet-leg.	Alu Guss-leg.	Stahl < 800 N/mm²	Stahl < 1200 N/mm²	Stahl < 1600 N/mm²	Stahl < 55 HRC	Stahl < 60 HRC	Stahl < 66 HRC	INOX < 800 N/mm²	INOX > 800 N/mm²	GG	GGG	hochw. Legierungen	Titan	NE-Metalle Cu-Leg.	Graphit & Faser-verbund	MMS	max.	ohne	AIR	
40-5800			○	●	●	●	○		○	○	●	●						●		●	●

● sehr gut geeignet / very suitable ○ bedingt geeignet / limited suitable

HAM 40-5800

Werkstoffgruppe material group	Ø mm	1	2	3	4	5	6	8	10
Stahl < 800 N/mm²	v_c [m/min]	230	230	230	230	230	230	230	230
	f_z [mm]	0,008	0,010	0,020	0,030	0,045	0,060	0,080	0,100
	v_f [mm/min]	770	730	980	1100	1310	1460	1470	1460
	n [1/min]	min. 50000	36600	24400	18300	14600	12200	9200	7300
Stahl < 1200 N/mm²	v_c [m/min]	190	210	210	230	230	250	280	280
	f_z [mm]	0,007	0,010	0,020	0,030	0,040	0,055	0,070	0,090
	v_f [mm/min]	700	670	890	1100	1170	1460	1550	1600
	n [1/min]	min. 50000	33400	22300	18300	14600	13300	11100	8900
Stahl < 1600 N/mm²	v_c [m/min]	160	160	160	160	160	160	160	160
	f_z [mm]	0,006	0,010	0,020	0,030	0,035	0,050	0,060	0,080
	v_f [mm/min]	600	510	680	760	710	850	760	820
	n [1/min]	min. 50000	25500	17000	12700	10200	8500	6400	5100
Stahl < 55 HRC	v_c [m/min]	115	115	115	115	115	115	115	115
	f_z [mm]	0,005	0,007	0,013	0,020	0,027	0,037	0,047	0,060
	v_f [mm/min]	340	250	330	370	390	450	430	450
	n [1/min]	36600	18300	12200	9200	7300	6100	4600	3700
Stahl < 60 HRC	v_c [m/min]	95	95	95	95	95	95	95	95
	f_z [mm]	0,004	0,006	0,012	0,020	0,025	0,034	0,040	0,060
	v_f [mm/min]	260	190	250	300	300	340	300	360
	n [1/min]	30200	15100	10100	7600	6000	5000	3800	3000
INOX < 800 N/mm²	v_c [m/min]	125	125	125	125	125	125	125	125
	f_z [mm]	0,005	0,010	0,020	0,025	0,030	0,045	0,060	0,070
	v_f [mm/min]	400	400	530	500	480	590	600	560
	n [1/min]	39800	19900	13300	9900	8000	6600	5000	4000
INOX > 800 N/mm²	v_c [m/min]	85	85	85	85	85	85	85	85
	f_z [mm]	0,005	0,007	0,013	0,020	0,027	0,037	0,047	0,060
	v_f [mm/min]	250	180	240	270	290	330	320	330
	n [1/min]	27100	13500	9000	6800	5400	4500	3400	2700
GG	v_c [m/min]	220	220	220	220	220	220	220	220
	f_z [mm]	0,008	0,010	0,020	0,030	0,045	0,060	0,080	0,100
	v_f [mm/min]	770	700	930	1050	1260	1400	1410	140
	n [1/min]	min. 50000	35000	23300	17500	14000	11700	8800	7000
GGG	v_c [m/min]	190	190	190	190	190	190	190	190
	f_z [mm]	0,007	0,010	0,020	0,030	0,040	0,055	0,070	0,090
	v_f [mm/min]	700	600	810	910	970	1110	1060	1080
	n [1/min]	min. 50000	30200	20200	15100	12100	10100	7600	6000

	Stahl < 800 N/mm²	Stahl < 1200 N/mm²	Stahl < 1600 N/mm²	Stahl < 55 HRC	Stahl < 60 HRC	INOX < 800 N/mm²	INOX > 800 N/mm²	GG	GGG
a_p	0,02 x D	0,02 x D	0,02 x D	0,02 x D	0,02 x D	0,02 x D	0,02 x D	0,02 x D	0,02 x D
a_e	0,05 x D	0,05 x D	0,05 x D	0,05 x D	0,05 x D	0,05 x D	0,05 x D	0,05 x D	0,05 x D

HAM 40-1880

Vollhartmetall-Gravierstichel
solid carbide engraving bits

VHM Z 1 0° Nut Werk Norm
Typ N HA
SHRINK FIT

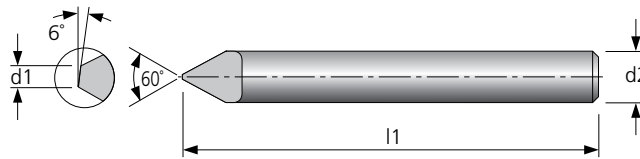

Material	Alu Knet-leg.	Alu Guss-leg.	Stahl < 800 N/mm²	Stahl < 1200 N/mm²	Stahl < 1600 N/mm²	Stahl < 55 HRC	Stahl < 60 HRC	Stahl < 66 HRC	INOX < 800 N/mm²	INOX > 800 N/mm²	GG	GGG	hochw. Legierungen	Titan	NE-Metalle Cu-Leg.	Graphit & Faserverbund	MMS	max.	ohne	AIR
40-1880	●	●	●	●	●						●	●			●	○	●	○	●	●

● sehr gut geeignet / very suitable ○ bedingt geeignet / limited suitable

HAM 40-1880			
Werkstoffgruppe material group	Ø mm	0,2	0,25
Alu Knetlegierungen	v _c [m/min]	200	200
	f _z [mm]	0,020	0,025
	v _f [mm/min]	4000	5000
	n [1/min]	min. 50000	min. 50000
Alu Gusslegierungen	v _c [m/min]	150	150
	f _z [mm]	0,020	0,025
	v _f [mm/min]	4000	5000
	n [1/min]	min. 50000	min. 50000
Stahl < 800 N/mm²	v _c [m/min]	100	100
	f _z [mm]	0,015	0,020
	v _f [mm/min]	3000	4000
	n [1/min]	min. 50000	min. 50000
Stahl < 1200 N/mm²	v _c [m/min]	80	80
	f _z [mm]	0,015	0,020
	v _f [mm/min]	3000	4000
	n [1/min]	min. 50000	min. 50000
Stahl < 1600 N/mm²	v _c [m/min]	50	50
	f _z [mm]	0,015	0,020
	v _f [mm/min]	3000	4000
	n [1/min]	min. 50000	min. 50000
GG	v _c [m/min]	100	100
	f _z [mm]	0,015	0,020
	v _f [mm/min]	3000	4000
	n [1/min]	min. 50000	min. 50000
GGG	v _c [m/min]	80	80
	f _z [mm]	0,015	0,020
	v _f [mm/min]	3000	4000
	n [1/min]	min. 50000	min. 50000
NE-Metalle Cu-Legierungen	v _c [m/min]	120	120
	f _z [mm]	0,020	0,025
	v _f [mm/min]	4000	5000
	n [1/min]	min. 50000	min. 50000
Graphit & Faserverbund	v _c [m/min]	80	80
	f _z [mm]	0,015	0,020
	v _f [mm/min]	3000	4000
	n [1/min]	min. 50000	min. 50000

HAM 40-1921

Vollhartmetall-Entgrat- und Fasfräser
solid carbide deburring and chamfering mill

VHM Z 4 8° rechts Werk Norm
Typ N DIN 6535 HA
90° SHRINK FIT
DIN 6535 HB

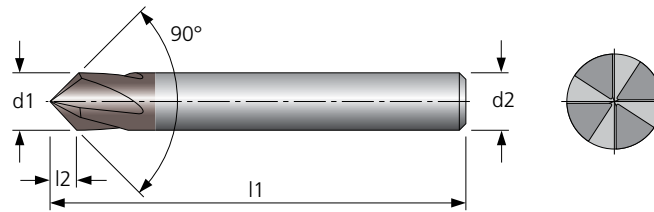

Material	Alu Knet-leg.	Alu Guss-leg.	Stahl < 800 N/mm²	Stahl < 1200 N/mm²	Stahl < 1600 N/mm²	Stahl < 55 HRC	Stahl < 60 HRC	Stahl < 66 HRC	INOX < 800 N/mm²	INOX > 800 N/mm²	GG	GGG	hochw. Legierungen	Titan	NE-Metalle Cu-Leg.	Graphit & Faserverbund	MMS	max.	ohne	AIR
40-1921	●	●	●	●	●	○			●	●	●	●	○	○	●	○	●	●	●	●

● sehr gut geeignet / very suitable ○ bedingt geeignet / limited suitable

HAM 40-1921

Werkstoffgruppe material group	Ø mm	4	6	8	10	12	16	20
Alu Knetlegierungen	v _c [m/min]	300	300	300	300	300	300	300
	f _z [mm]	0,060	0,070	0,080	0,100	0,120	0,130	0,150
	v _f [mm/min]	5740	4450	3810	3800	3100	2860	2860
	n [1/min]	23900	15900	11900	9500	8000	5970	4780
Alu Gusslegierungen	v _c [m/min]	250	250	250	250	250	250	250
	f _z [mm]	0,048	0,056	0,065	0,080	0,100	0,110	0,130
	v _f [mm/min]	3820	2980	2570	2560	2640	2200	2070
	n [1/min]	19900	13300	9900	8000	6600	4980	4000
Stahl < 800 N/mm²	v _c [m/min]	180	180	180	180	180	180	180
	f _z [mm]	0,050	0,060	0,070	0,080	0,080	0,090	0,120
	v _f [mm/min]	2860	2280	2020	1820	1540	1300	1375
	n [1/min]	14300	9500	7200	5700	4800	3600	2900
Stahl < 1200 N/mm²	v _c [m/min]	150	150	150	150	150	150	150
	f _z [mm]	0,030	0,040	0,050	0,060	0,060	0,070	0,090
	v _f [mm/min]	1430	1280	1200	1150	960	835	860
	n [1/min]	11900	8000	6000	4800	4000	3000	2400
Stahl < 1600 N/mm²	v _c [m/min]	125	125	125	125	125	125	125
	f _z [mm]	0,025	0,030	0,040	0,050	0,050	0,060	0,080
	v _f [mm/min]	990	790	800	800	660	600	640
	n [1/min]	9900	6600	5000	4000	3300	2500	2000
Stahl < 55 HRC	v _c [m/min]	90	90	90	90	90	90	90
	f _z [mm]	0,020	0,026	0,033	0,040	0,040	0,050	0,060
	v _f [mm/min]	570	500	470	460	380	360	340
	n [1/min]	7160	4770	3580	2860	2380	1800	1400
INOX < 800 N/mm²	v _c [m/min]	100	100	100	100	100	100	100
	f _z [mm]	0,020	0,025	0,030	0,040	0,050	0,060	0,080
	v _f [mm/min]	640	530	480	510	540	480	510
	n [1/min]	8000	5300	4000	3200	2700	2000	1600
INOX > 800 N/mm²	v _c [m/min]	70	70	70	70	70	70	70
	f _z [mm]	0,015	0,020	0,025	0,030	0,040	0,050	0,070
	v _f [mm/min]	340	300	280	260	300	280	310
	n [1/min]	5600	3700	2800	2200	1900	1400	1100
GG	v _c [m/min]	170	170	170	170	170	170	170
	f _z [mm]	0,040	0,050	0,060	0,070	0,080	0,090	0,110
	v _f [mm/min]	2160	1800	1630	1510	1440	1200	1200
	n [1/min]	13500	9000	6800	5400	4500	3400	2700
GGG	v _c [m/min]	150	150	150	150	150	150	150
	f _z [mm]	0,030	0,040	0,050	0,060	0,060	0,070	0,070
	v _f [mm/min]	1430	1280	1200	1150	960	840	670
	n [1/min]	11900	8000	6000	4800	4000	3000	2400
hochwarmfeste Legierungen	v _c [m/min]	60	60	60	60	60	60	60
	f _z [mm]	0,015	0,020	0,025	0,030	0,040	0,050	0,060
	v _f [mm/min]	290	260	240	230	260	240	230
	n [1/min]	4800	3200	2400	1900	1600	1200	960
Titan	v _c [m/min]	85	85	85	85	85	85	85
	f _z [mm]	0,015	0,020	0,025	0,030	0,040	0,050	0,060
	v _f [mm/min]	400	360	340	330	260	340	320
	n [1/min]	6800	4500	3400	2700	2250	1700	1350
NE-Metalle Cu-Legierungen	v _c [m/min]	200	200	200	200	200	200	200
	f _z [mm]	0,036	0,042	0,048	0,060	0,075	0,090	0,130
	v _f [mm/min]	2290	1780	1540	1540	1590	1430	1650
	n [1/min]	15900	10600	8000	6400	5300	4000	3200
Graphit & Faserverbund	v _c [m/min]	200	200	200	200	200	200	200
	f _z [mm]	0,060	0,070	0,080	0,100	0,120	0,140	0,160
	v _f [mm/min]	3820	2970	2560	2560	2540	2200	2000
	n [1/min]	15900	10600	8000	6400	5300	4000	3200

HAM 40-1961

Vollhartmetall-Entgrat- und Fasfräser
solid carbide deburring and chamfering mill

VHM
Z 4
8° rechts
Werk Norm

Typ N
DIN 6535 HA

60°
SHRINK FIT

DIN 6535 HB

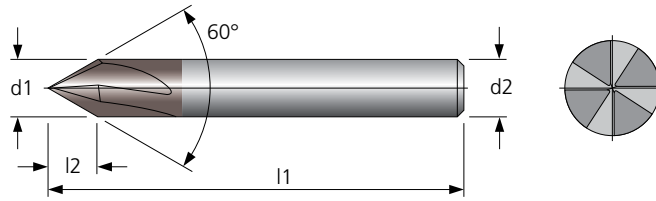

Material	Alu Knet-leg.	Alu Guss-leg.	Stahl < 800 N/mm²	Stahl < 1200 N/mm²	Stahl < 1600 N/mm²	Stahl < 55 HRC	Stahl < 60 HRC	Stahl < 66 HRC	INOX < 800 N/mm²	INOX > 800 N/mm²	GG	GGG	hochw. Legierungen	Titan	NE-Metalle Cu-Leg.	Graphit & Faser-verbund	MMS	max.	ohne	AIR
40-1961	●	●	●	●	●	○			●	●	●	●	○	○	●	○	●	●	●	●

● sehr gut geeignet / very suitable ○ bedingt geeignet / limited suitable

HAM 40-1961

Werkstoffgruppe material group	Ø mm	4	6	8	10	12
Alu Knetlegierungen	v _c [m/min]	300	300	300	300	300
	f _z [mm]	0,060	0,070	0,080	0,100	0,120
	v _f [mm/min]	5740	4450	3810	3800	3840
	n [1/min]	23900	15900	11900	9500	8000
Alu Gusslegierungen	v _c [m/min]	250	250	250	250	250
	f _z [mm]	0,048	0,056	0,065	0,080	0,100
	v _f [mm/min]	3820	2980	2570	2560	2640
	n [1/min]	19900	13300	9900	8000	6600
Stahl < 800 N/mm²	v _c [m/min]	180	180	180	180	180
	f _z [mm]	0,050	0,060	0,070	0,080	0,080
	v _f [mm/min]	2860	2280	2020	1820	1540
	n [1/min]	14300	9500	7200	5700	4800
Stahl < 1200 N/mm²	v _c [m/min]	150	150	150	150	150
	f _z [mm]	0,030	0,040	0,050	0,060	0,060
	v _f [mm/min]	1430	1280	1200	1150	960
	n [1/min]	11900	8000	6000	4800	4000
Stahl < 1600 N/mm²	v _c [m/min]	125	125	125	125	125
	f _z [mm]	0,025	0,030	0,040	0,050	0,050
	v _f [mm/min]	990	790	800	800	660
	n [1/min]	9900	6600	5000	4000	3300
Stahl < 55 HRC	v _c [m/min]	90	90	90	90	90
	f _z [mm]	0,020	0,026	0,033	0,040	0,040
	v _f [mm/min]	570	500	470	460	380
	n [1/min]	7160	4770	3580	2860	2380
INOX < 800 N/mm²	v _c [m/min]	100	100	100	100	100
	f _z [mm]	0,020	0,025	0,030	0,040	0,050
	v _f [mm/min]	640	530	480	510	540
	n [1/min]	8000	5300	4000	3200	2700
INOX > 800 N/mm²	v _c [m/min]	70	70	70	70	70
	f _z [mm]	0,015	0,020	0,025	0,030	0,040
	v _f [mm/min]	340	300	280	260	300
	n [1/min]	5600	3700	2800	2200	1900
GG	v _c [m/min]	170	170	170	170	170
	f _z [mm]	0,040	0,050	0,060	0,070	0,080
	v _f [mm/min]	2160	1800	1630	1510	1440
	n [1/min]	13500	9000	6800	5400	4500
GGG	v _c [m/min]	150	150	150	150	150
	f _z [mm]	0,030	0,040	0,050	0,060	0,060
	v _f [mm/min]	1430	1280	1200	1150	960
	n [1/min]	11900	8000	6000	4800	4000
hochwarmfeste Legierungen	v _c [m/min]	60	60	60	60	60
	f _z [mm]	0,015	0,020	0,025	0,030	0,040
	v _f [mm/min]	290	260	240	230	260
	n [1/min]	4800	3200	2400	1900	1600
Titan	v _c [m/min]	85	85	85	85	85
	f _z [mm]	0,015	0,020	0,025	0,030	0,040
	v _f [mm/min]	400	360	340	330	260
	n [1/min]	6800	4500	3400	2700	2250
NE-Metalle Cu-Legierungen	v _c [m/min]	200	200	200	200	200
	f _z [mm]	0,036	0,042	0,048	0,060	0,075
	v _f [mm/min]	2290	1780	1540	1540	1590
	n [1/min]	15900	10600	8000	6400	5300
Graphit & Faserverbund	v _c [m/min]	200	200	200	200	200
	f _z [mm]	0,060	0,070	0,080	0,100	0,120
	v _f [mm/min]	3820	2970	2560	2560	2540
	n [1/min]	15900	10600	8000	6400	5300

HAM 40-2001

Vollhartmetall-Viertelkreisfräser konkav
solid carbide corner-rounding concave cutter

VHM Z 4 0° Nut Werk Norm
Typ N HA
SHRINK FIT
HB

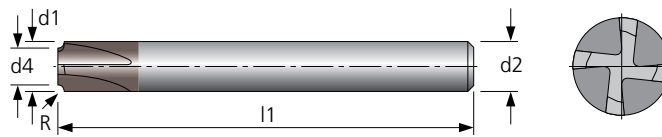

Material	Alu Knetleg.	Alu Gussleg.	Stahl < 800 N/mm²	Stahl < 1200 N/mm²	Stahl < 1600 N/mm²	Stahl < 55 HRC	Stahl < 60 HRC	Stahl < 66 HRC	INOX < 800 N/mm²	INOX > 800 N/mm²	GG	GGG	hochw. Legierungen	Titan	NE-Metalle Cu-Leg.	Graphit & Faserverbund	MMS	max.	ohne	AIR
40-2001	●	●	●	●	●	○			●	●	●	●	○	○	●	○	●	●	●	●

● sehr gut geeignet / very suitable ○ bedingt geeignet / limited suitable

HAM 40-2001

Werkstoffgruppe material group	Ø mm	6	8	10	12	16	20
Alu Knetlegierungen	v _c [m/min]	200	200	200	200	200	200
	f _z [mm]	0,020	0,025	0,030	0,035	0,040	0,045
	v _f [mm/min]	850	800	770	740	640	580
	n [1/min]	10600	8000	6400	5300	4000	3200
Alu Gusslegierungen	v _c [m/min]	150	150	150	150	150	150
	f _z [mm]	0,020	0,025	0,030	0,035	0,040	0,045
	v _f [mm/min]	640	600	580	560	480	430
	n [1/min]	8000	6000	4800	4000	3000	2400
Stahl < 800 N/mm²	v _c [m/min]	100	100	100	100	100	100
	f _z [mm]	0,015	0,020	0,025	0,030	0,035	0,040
	v _f [mm/min]	320	320	320	320	280	260
	n [1/min]	5300	4000	3200	2700	2000	1600
Stahl < 1200 N/mm²	v _c [m/min]	80	80	80	80	80	80
	f _z [mm]	0,015	0,020	0,025	0,030	0,035	0,040
	v _f [mm/min]	250	260	250	250	220	210
	n [1/min]	4200	3200	2500	2100	1600	1300
Stahl < 1600 N/mm²	v _c [m/min]	50	50	50	50	50	50
	f _z [mm]	0,015	0,020	0,025	0,030	0,035	0,040
	v _f [mm/min]	160	160	160	160	140	130
	n [1/min]	2700	2000	1600	1300	1000	800
Stahl < 55 HRC	v _c [m/min]	20	20	20	20	20	20
	f _z [mm]	0,010	0,013	0,017	0,020	0,023	0,027
	v _f [mm/min]	40	40	40	40	40	30
	n [1/min]	1100	800	600	500	400	300
INOX < 800 N/mm²	v _c [m/min]	40	40	40	40	40	40
	f _z [mm]	0,015	0,020	0,025	0,030	0,035	0,040
	v _f [mm/min]	130	130	130	130	110	100
	n [1/min]	2100	1600	1300	1100	800	600
INOX > 800 N/mm²	v _c [m/min]	30	30	30	30	30	30
	f _z [mm]	0,015	0,020	0,025	0,030	0,035	0,040
	v _f [mm/min]	100	100	100	100	80	80
	n [1/min]	1600	1200	1000	800	600	500
GG	v _c [m/min]	100	100	100	100	100	100
	f _z [mm]	0,015	0,020	0,025	0,030	0,035	0,040
	v _f [mm/min]	320	320	320	320	280	260
	n [1/min]	5300	4000	3200	2700	2000	1600
GGG	v _c [m/min]	80	80	80	80	80	80
	f _z [mm]	0,015	0,020	0,025	0,030	0,035	0,040
	v _f [mm/min]	250	260	250	250	220	210
	n [1/min]	4200	3200	2500	2100	1600	1300
hochwarmfeste Legierungen	v _c [m/min]	70	70	70	70	70	70
	f _z [mm]	0,010	0,013	0,016	0,020	0,023	0,026
	v _f [mm/min]	140	150	140	150	130	110
	n [1/min]	3700	2800	2200	1900	1400	1100
Titan	v _c [m/min]	30	30	30	30	30	30
	f _z [mm]	0,010	0,013	0,017	0,020	0,023	0,027
	v _f [mm/min]	60	60	70	60	60	50
	n [1/min]	1600	1200	1000	800	600	500
NE-Metalle Cu-Legierungen	v _c [m/min]	120	120	120	120	120	120
	f _z [mm]	0,020	0,025	0,030	0,035	0,040	0,045
	v _f [mm/min]	510	480	460	450	380	340
	n [1/min]	6400	4800	3800	3200	2400	1900
Graphit & Faserverbund	v _c [m/min]	80	80	80	80	80	80
	f _z [mm]	0,015	0,020	0,025	0,030	0,035	0,040
	v _f [mm/min]	250	260	250	250	220	210
	n [1/min]	4200	3200	2500	2100	1600	1300

HAM 40-2041

Vollhartmetall-Entgrat- und Fasrfräser
solid carbide deburring and chamfering mill

VHM Z 4 0° Nut Werk Norm
Typ N HA
SHRINK FIT
HB

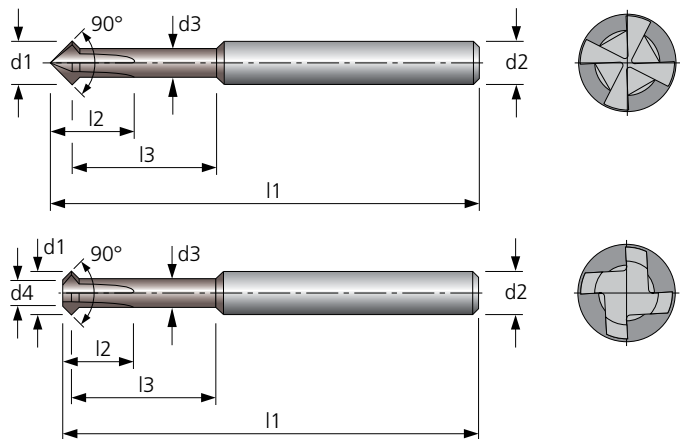

Material	Alu Knet-leg.	Alu Guss-leg.	Stahl < 800 N/mm²	Stahl < 1200 N/mm²	Stahl < 1600 N/mm²	Stahl < 55 HRC	Stahl < 60 HRC	Stahl < 66 HRC	INOX < 800 N/mm²	INOX > 800 N/mm²	GG	GGG	hochw. Legierungen	Titan	NE-Metalle Cu-Leg.	Graphit & Faser-verbund	MMS	max.	ohne	AIR
40-2041	●	●	●	●	●	○	○	○	●	●	●	●	○	○	●	○	●	○	○	●

● sehr gut geeignet / very suitable ○ bedingt geeignet / limited suitable

HAM 40-2041

Werkstoffgruppe material group	Ø mm	2,8	3,8	4,8	5,8	7,8	9,8
Alu Knetlegierungen	v _c [m/min]	200	200	200	200	200	200
	f _z [mm]	0,020	0,025	0,030	0,035	0,040	0,045
	v _f [mm/min]	1820	1680	1600	1540	1310	1170
	n [1/min]	22700	16800	13300	11000	8200	6500
Alu Gusslegierungen	v _c [m/min]	150	150	150	150	150	150
	f _z [mm]	0,020	0,025	0,030	0,035	0,040	0,045
	v _f [mm/min]	1370	1260	1190	1150	980	880
	n [1/min]	17100	12600	9900	8200	6100	4900
Stahl < 800 N/mm²	v _c [m/min]	100	100	100	100	100	100
	f _z [mm]	0,015	0,020	0,025	0,030	0,035	0,040
	v _f [mm/min]	680	670	660	660	570	510
	n [1/min]	11400	8400	6600	5500	4100	3200
Stahl < 1200 N/mm²	v _c [m/min]	80	80	80	80	80	80
	f _z [mm]	0,015	0,020	0,025	0,030	0,035	0,040
	v _f [mm/min]	550	540	530	530	460	420
	n [1/min]	9100	6700	5300	4400	3300	2600
Stahl < 1600 N/mm²	v _c [m/min]	50	50	50	50	50	50
	f _z [mm]	0,015	0,020	0,025	0,030	0,035	0,040
	v _f [mm/min]	340	340	330	320	280	260
	n [1/min]	5700	4200	3300	2700	2000	1600
Stahl < 55 HRC	v _c [m/min]	20	20	20	20	20	20
	f _z [mm]	0,010	0,013	0,017	0,020	0,023	0,027
	v _f [mm/min]	90	90	90	90	80	60
	n [1/min]	2300	1700	1300	1100	800	600
INOX < 800 N/mm²	v _c [m/min]	40	40	40	40	40	40
	f _z [mm]	0,015	0,020	0,025	0,030	0,035	0,040
	v _f [mm/min]	270	270	270	260	220	210
	n [1/min]	4500	3400	2700	2200	1600	1300
INOX > 800 N/mm²	v _c [m/min]	30	30	30	30	30	30
	f _z [mm]	0,015	0,020	0,025	0,030	0,035	0,040
	v _f [mm/min]	200	200	200	190	170	160
	n [1/min]	3400	2500	2000	1600	1200	1000
GG	v _c [m/min]	100	100	100	100	100	100
	f _z [mm]	0,015	0,020	0,025	0,030	0,035	0,040
	v _f [mm/min]	680	670	660	660	570	510
	n [1/min]	11400	8400	6600	5500	4100	3200
GGG	v _c [m/min]	80	80	80	80	80	80
	f _z [mm]	0,015	0,020	0,025	0,030	0,035	0,040
	v _f [mm/min]	550	540	530	530	460	420
	n [1/min]	9100	6700	5300	4400	3300	2600

HAM 40-2041							
Werkstoffgruppe material group	Ø mm	2,8	3,8	4,8	5,8	7,8	9,8
hochwarmfeste Legierungen	v _c [m/min]	70	70	70	70	70	70
	f _z [mm]	0,010	0,013	0,016	0,020	0,023	0,026
	v _f [mm/min]	310	310	300	300	260	240
	n [1/min]	8000	5900	4600	3800	2900	2300
Titan	v _c [m/min]	30	30	30	30	30	30
	f _z [mm]	0,010	0,013	0,017	0,020	0,023	0,027
	v _f [mm/min]	140	130	130	130	110	110
	n [1/min]	3400	2500	2000	1600	1200	1000
NE-Metalle Cu-Legierungen	v _c [m/min]	120	120	120	120	120	120
	f _z [mm]	0,020	0,025	0,030	0,035	0,040	0,045
	v _f [mm/min]	1090	1010	960	920	780	700
	n [1/min]	13600	10100	8000	6600	4900	3900
Graphit & Faserverbund	v _c [m/min]	80	80	80	80	80	80
	f _z [mm]	0,015	0,020	0,025	0,030	0,035	0,040
	v _f [mm/min]	550	540	530	530	460	420
	n [1/min]	9100	6700	5300	4400	3300	2600

HAM Produkt- und Dienstleistungen

Wir bieten seit Jahren unseren Kunden eine gute und optimale Beratung.

Diese Dienstleistung unseres Unternehmens kostet viel Zeit und Geld. Für diese immer wichtigere Aufgabe wollen wir noch mehr qualifizierte Mitarbeiter einsetzen. Die anfallenden Kosten für solche entsprechenden Leistungen sollten jedoch nicht in die Werkzeugkalkulation eingehen, da bei Kostenvergleichen Wettbewerbsverzerrungen entstehen.

Wenn Sie bereit sind, bei mittleren und großen Projekten, die mit entsprechenden Beratungs- und Konstruktionskosten verbunden sind, unseren Aufwand zu vergüten, wie jede entsprechende Dienstleistung Ihres Hauses, können wir unsere Beratungsangebote weiter intensivieren und ausbauen.

Übliche Kurzberatungen werden natürlich weiterhin für unsere Kunden und Interessenten nicht berechnet.

- | | |
|---|---|
| 1) Beratung in Zerspanungsfragen und Werkzeugauslegung Bohren – Fräsen – Reiben | ▶ auf Anforderung des Kunden Berechnung nach Zeit und Aufwand |
| 2) Projekt-Bearbeitung und umfangreiche Beschreibung bei Angeboten | ▶ auf Anforderung des Kunden Berechnung nach Zeit und Aufwand |
| 3) Preis-Angebote und Kurzbeschreibungen | ▶ kostenlos |
| 4) Detailkonstruktion von Spezialwerkzeugen für Kunden mit CAD | ▶ auf Bestellung des Kunden Berechnung nach Zeit und Aufwand |
| 5) Lieferung von Spezialwerkzeugen aus Vollhartmetall, Cermet, Schneidkeramik, polykristallinem Diamant und anderen Produkten | ▶ auf Bestellung des Kunden entsprechend Angebot |
| 6) Prüfung mit Messprotokoll auf Messmaschine für komplizierte Werkzeuge | ▶ auf Bestellung des Kunden Berechnung nach Zeit und Aufwand |
| 7) Nachschleif-Service Bohrer, Fräser, Reibahlen | ▶ auf Bestellung des Kunden Berechnung nach Zeit und Aufwand |

Nachstehend unsere derzeit gültigen Verrechnungssätze:

- Als Reisekosten werden bei Benutzung öffentlicher Verkehrsmittel die tatsächlichen Ausgaben in Rechnung gestellt.
- Bei Benutzung eines firmeneigenen PKWs berechnen wir Euro 0,50 je km.
- Muss ein Mietwagen in Anspruch genommen werden, so werden die Ausgaben gemäß Rechnung berechnet.
- Die Auslösung je Kalendertag beträgt 26,00 Euro.
- Bei Übernachtung sind die anfallenden Hotelkosten zu erstatten.
- Arbeitsstunden, Wartestunden und Reisestunden für Servicetechniker und Monteure 50,00 Euro je Stunde, für Ingenieure 75,00 Euro je Stunde.
- Stundensätze
Preise für Beratung, Projekt-Bearbeitung, Beschreibung und Konstruktion:
Techniker 125,00 – 150,00 Euro je Stunde.
- Bei Überstunden- sowie Sonn- und Feiertagszuschlägen gelten die für uns gesetzlich gültigen Zuschläge.
- Für die Prozessfunktion und für eventuell direkte oder indirekte Schäden aufgrund unserer Beratung kann keine Haftung übernommen werden. Bei Nichtfunktion haften wir nur in der Weise, dass wir eine weitere kostenlose Beratung anbieten. Weitere Ansprüche können von uns nicht berücksichtigt werden.

Für Montagefehler und die hieraus resultierenden direkten oder indirekten Schäden haften wir nur in der Weise, indem wir lediglich die Montage erneut kostenlos vornehmen. Ansprüche darüber hinaus können von uns nicht berücksichtigt werden.

Wir behalten uns vor, die aufgeführten Sätze zu erhöhen, falls sich die tariflichen Löhne und Gehälter ändern.

HAM Product- and customer service

We have been offering best and optimal advise to our customers already for many years.

This service of our company is very time and cost expensive. We would like to employ much more qualified staff for this very important task. However, the costs arised for this service should not effect the calculation of the tools, as cost comparisons will cause difficulties with the competition.

If you are willing to honour our costs for advise and design for medium and large projects, we can intensify and improve our consultation.

Other short consultion is naturally furtheron of no charge for our customers.

- | | |
|---|---|
| 1) Advise on cutting parameters and drilling-milling-reaming | ▶ on customer's request charges acc. to time and work |
| 2) Project handling and full advise for quotation | ▶ on customer's request charges acc. to time and work |
| 3) Quotations and short explanations | ▶ free of charge |
| 4) Detailed design of special tools for customers with CAD | ▶ on customer's order charges acc. to time and work |
| 5) Delivery of special tools in solid carbide, cermet, cutting cermet, polycrystalline diamond and other products | ▶ on customer's order acc. to quotation |
| 6) Inspection with data sheet for difficult tools on measuring machine | ▶ on customer's order charges acc. to time and work |
| 7) Regrinding service drills, end mills, reamers | ▶ on customer's order charges acc. to time and work |

Our service charges valid at the present time are as follows:

- The actual costs are invoiced as travelling allowance when using public transportation means.
- When using a company car we charge 0,50 Euro per km.
- If a rental car has to be used, the costs are charged acc. to invoice.
- The allowance chargeable per day is 26,00 Euro.
- When staying overnight the hotel costs have to be paid.
- Working hours, waiting hours and travelling hours for our service technicians and assembly persons are charged at a rate of 50,00 Euro per hour, for engineers at 75,00 Euro per hour.
- Daily rates
Prices for consultation, project revision, explanation and design:
Technician 125,00 – 150,00 Euro per hour.
- The legal extra charges are valid for overtime, as well as for sundays and public holidays.
- We cannot be held liable for the process function, nor for possible direct or indirect damages caused as the result of our advise. In case of non-function, we can only offer some additional advise free of charge. Further claims cannot be accepted by us.

For assembly errors and for direct or indirect damages resulting thereof, we are only liable by doing the assembly again free of charge. Additional claims cannot be accepted by us.

We reserve the right to increase the above charges, if the tariff wages and salaries change.

Zuschläge für Zwischenabmessungen Extra charges for intermediate sizes

Mehrpreis für Vollhartmetall-Bohrer in Zwischenabmessungen Die Zuschläge werden auf die Nettopreise der nächstgrößeren Abmessungen berechnet. Der Mindestbestellwert für eine Zwischenabmessung beträgt für Bohrer 60,00 Euro pro Bestellposition.	Stück quantity	bis / up to 8,0 mm Euro/Stück / pcs	bis / up to 12,0 mm Euro/Stück / pcs	bis / up to 20,0 mm Euro/Stück / pcs	
Extra charge for solid carbide drills in intermediate sizes The extra charges are added to the next higher size. The minimum order value for drills is 60,00 Euro per order item.	1	–	–	–	
	2	–	–	31,60	
	3	15,90	21,10	26,40	
	4 – 6	9,50	12,70	15,90	
	7 – 11	5,40	6,40	9,50	
	12 – 15	4,00	5,40	7,40	
	16 – 20	3,50	4,50	5,90	
	21 – 30	3,00	4,00	5,10	
	31 – 40	2,70	3,70	4,70	
	41 – 49	2,20	3,20	4,20	
	50 – größere Mengen sind aufpreisfrei 50 – for larger quantities there is no extra charge				

























Zuschläge für Zwischenabmessungen und andere Passungen als H7 bei Vollhartmetall-Reibahlen 1. Lagermäßig führen wir unsere Reibahlen in der Passung H7. Gewünschte Passung bitte angeben. 2. Werden bei Bestellungen keine Passungsangaben gemacht, wird die Lagerpassung H7 geliefert. 3. Bei Zwischenabmessungen wird der Zuschlag auf den nächsthöheren Grundpreis berechnet. 4. Die Zuschläge werden netto pro Stück berechnet. 5. Der Mindestbestellwert für eine Zwischenabmessung beträgt für Reibahlen 60,00 Euro pro Bestellposition.	Stück quantity	Euro/Stück / pcs
Extra charges for intermediate sizes and other fits than H7 for solid carbide reamers 1. Our reamers are available ex stock in H7. Please advise the required fit. 2. If the required fit is not specified in the order, the available fit H7 is delivered. 3. For intermediate sizes the extra charge ist added to the next higher standard price. 4. Extra charges are invoiced net per piece. 5. The minimum order value for reamers is 60,00 Euro per order item.	1	–
	2	21,10
	3	14,10
	4	10,60
	5	6,40
	6 – 8	5,40
	9 – 10	4,20
	11 – 15	2,70
	16 – 20	2,20
	21 – 29	1,70
30 – größere Mengen sind aufpreisfrei 30 – for larger quantities there is no extra charge		

Verschleißschutz für Nichteisenwerkstoffe Wear protection for non-ferrous materials

HAM CVOC² spezielle Oberflächenbehandlung zum Verschleißschutz für Nichteisenwerkstoffe	Preis auf Anfrage price on request
HAM CVOC² special surface treatment for wear protection for non-ferrous materials	



Mindestabnahmemengen für HAM CVOC² Minimum order quantities for HAM CVOC ²	Ø / dia.	Stück / pcs.
	0,25 – 2,50	200
	2,60 – 4,50	100
	4,60 – 5,90	50
	6,00 – 9,90	30
	10,00 – 14,90	20
	15,00 – 20,00	10

Piktogramm-Übersicht Bohren – Senken – Reiben Overview of pictograms drilling – countersinking – reaming





Schneidstoff <i>cutting material</i>	VHM	Feinstkorn Vollhartmetall <i>solid carbide ultra micro grain</i>	PKD	PKD-Schneide <i>PCD cutting edge</i>						
Typ <i>type</i>	Typ N	normal <i>normal</i>	Typ W	für weiche Werkstoffe <i>for soft materials</i>	Typ Werk	Werknorm <i>HAM standard</i>				
Zähnezahl <i>number of teeth</i>	Z 2	Z 3	Z 4	Z 3-4	Z 4-8					
Norm <i>standard</i>	Werk Norm	Werknorm <i>HAM standard</i>	DIN 333 A							
Schneidlänge <i>cutting length</i>		5 x Durchmesser <i>5 x diameter</i>		20 x Durchmesser <i>20 x diameter</i>		40 x Durchmesser <i>40 x diameter</i>				
Schaft <i>shank</i>		Zylinderschaft nach DIN <i>cylindrical shank acc. DIN</i>		Spannfläche Weldon <i>clamping fixture weldon</i>		Spannfläche Whistle Notch <i>clamping fixture whistle notch</i>		Zylinderschaft <i>cylindrical shank</i>		
		Schaft HA mit IK <i>shank HA with IC</i>		Schaft HB mit IK <i>shank HB with IC</i>		Schaft HE mit IK <i>shank HE with IC</i>		für Schrumpffutter geeignet <i>shrink fit</i>		
Spiralwinkel <i>helix angle</i>										
Spitzenwinkel <i>point angle</i>										
techn. Ausführung <i>technical design</i>		Ausspitzung <i>web thinning</i>		Innenkühlung <i>interior coolant</i>		liquid boost <i>liquid boost</i>		Stufenbohrer <i>step drill</i>		Eckenfase <i>corner chamfer</i>
	H 7	Toleranz <i>tolerance</i>	HSF	Spezial-Poliervverfahren <i>special-polishing process</i>						
Anwendung <i>application</i>	HPC	<i>High Performance Cutting</i>								

Piktogramm-Übersicht Fräsen Overview of pictograms milling





Schneidstoff cutting material

 Feinstkorn Vollhartmetall solid carbide ultra micro grain	 PKD-Schneide PCD cutting edge
--	--



Typ type

 normal normal	 für weiche Werkstoffe for soft materials	 für harte Werkstoffe for hard materials	 für harte Werkstoffe mit Schruppverzahnung for hard materials with roughing serration
--	---	--	--









Zähnezahl number of teeth

 Z 2	 Z 3	 Z 4	 Z 3-4	 Z 4-8
---	---	---	---	---

Norm standard

 Werknorm HAM standard	 DIN 6527
--	--

Schaft shank

 Zylinderschaft nach DIN cylindrical shank acc. DIN	 Spannfläche Weldon clamping fixture weldon	 Spannfläche Whistle Notch clamping fixture whistle notch	 Zylinderschaft cylindrical shank
 Schaft HA mit IK shank HA with IC	 Schaft HB mit IK shank HB with IC	 Schaft HE mit IK shank HE with IC	 für Schrumpffutter geeignet shrink fit















Spiralwinkel helix angle

 0° Nut	 30° rechts	 45° rechts	 35°/38° re	 22°-25° re
--	--	--	--	--

techn. Ausführung technical design

 Eckenradius corner radius	 Spezial-Polierverfahren special-polishing process
--	--

Anwendung application

 Werkzeug- und Formenbau tool design and mould and die production				
 Umfangfräsen periphery milling	 Nutfräsen slot milling	 Rippenfräsen rib milling	 Fasfräsen chamfer milling	 Kopierfräsen copy milling
 Umfangfräsen periphery milling	 Nutfräsen slot milling	 Gravieren engraving	 Fasfräsen chamfer milling	 Vor- / Rückwärtsbearbeitung forward / backward chamfering
 Umfangfräsen periphery milling	 Bearbeitungsrichtung machining direction	 High Speed Cutting	 High Performance Cutting	

Anfrageformular für Sonderwerkzeuge Bohren Inquiry form for special tools drilling

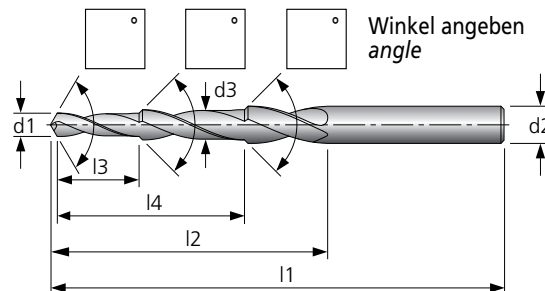
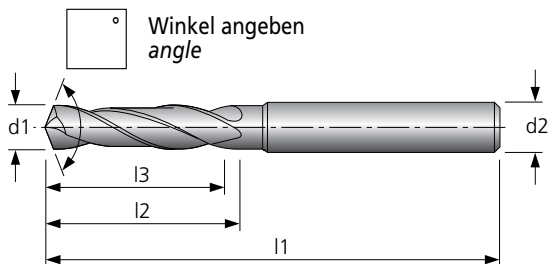

Stückzahl
pieces

d1 Schneidendurchmesser
cutting diameter

d2 Schaftdurchmesser
shank diameter

d3 Stufendurchmesser
step diameter

l1 Gesamtlänge
over all length

l2 Nutlänge
flute length

l3 Schneidlänge (Stufenlänge 1)
cutting length (step length 1)

l4 Stufenlänge 2
step length 2

zu bearbeitender Werkstoff
workpiece material

Beschichtungen/coatings

Ja
yes

Nein
no

Gewünschter Liefertermin
delivery

Bohrer
drill

Stufenbohrer
step drill

Innenkühlung
interior coolant

Zähnezahl
teeth

Drallwinkel
helix angle

rechtsspiralig
right hand fluted

linksspiralig
left hand fluted

rechtsschneidend
right hand cutting

linksschneidend
left hand cutting

Schaftform HA
shank HA

Schaftform HB (Weldon)
shank HB

Schaftform HE (Whistle Notch)
shank HE

Zylinderschaft
cylindrical shank

Bitte alle Punkte beantworten. Ohne diese Details ist eine Angebotsabgabe nicht möglich.
We need all information for a detailed quotation.

Absender
Dealer

Anfrageformular für Sonderwerkzeuge Fräsen Inquiry form for special tools milling

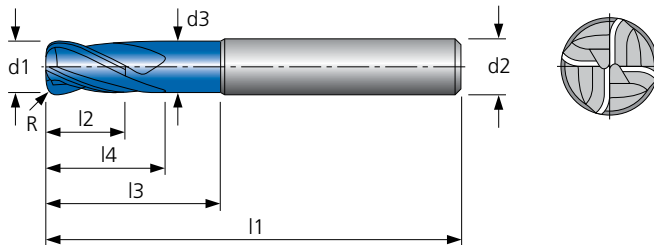

Stückzahl <i>pieces</i>	Gewünschter Liefertermin <i>delivery</i>
d1 Schneidendurchmesser <i>cutting diameter</i>	<input type="checkbox"/> R Eckenradius <i>R chamfer radius</i>
d2 Schaftdurchmesser <i>shank diameter</i>	<input type="checkbox"/> Vollradius <i>radius</i>
d3 Halsdurchmesser <i>neck diameter</i>	<input type="checkbox"/> stirnschneidend <i>centre cutting</i>
l1 Gesamtlänge <i>over all length</i>	<input type="checkbox"/> Innenkühlung <i>interior coolant</i>
l2 Schneidlänge <i>cutting length</i>	Zähnezahl <i>teeth</i>
l3 Halslänge <i>neck length</i>	Drallwinkel <i>helix angle</i>
l4 Nutlänge <i>flute length</i>	<input type="checkbox"/> rechtsspiralig <i>right fluted</i> <input type="checkbox"/> linksspiralig <i>left fluted</i>
zu bearbeitender Werkstoff <i>workpiece material</i>	<input type="checkbox"/> rechtsschneidend <i>right hand cutting</i> <input type="checkbox"/> linksschneidend <i>left hand cutting</i>
Beschichtungen/ <i>coatings</i>	<input type="checkbox"/> Schaftform HA <i>shank HA</i>
<input type="checkbox"/> Ja <i>yes</i>	<input type="checkbox"/> Schaftform HB (Weldon) <i>shank HB</i>
<input type="checkbox"/> Nein <i>no</i>	<input type="checkbox"/> Schaftform HE (Whistle Notch) <i>shank HE</i>

Bitte alle Punkte beantworten. Ohne diese Details ist eine Angebotsabgabe nicht möglich.
We need all information for a detailed quotation.

Absender
Dealer



HAM entwickelt und produziert Werkzeuge und Werkzeug-Systeme für den weltweiten Markt.

HAM – Ihr kompetenter Partner in der Präzisionswerkzeug-Technologie

- Vollhartmetall-, Cermet-, Keramik-Werkzeuge zum Bohren, Senken, Fräsen und Reiben
- Hartmetall-, Diamant- und CBN-Werkzeuge mit allen modularen Schnittstellen als Monoblockwerkzeuge, Wendeplatten- und Kassettenwerkzeuge (grob und fein einstellbar) zum Bohren und Senken, zum Fräsen und für die Vor- und Feinstbearbeitung
- Projektplanung und Projektengineering
- Weltweiter TCM-Partner für Tool Management Systeme in der Automobil- und Flugzeug-industrie und ihren Zulieferbetrieben
- Vollhartmetall-Bohr- und Fräswerkzeuge für die Leiterplattenindustrie

HAM ist zertifiziert nach DIN EN ISO 9001, VDA 6.4 und DIN EN ISO 13485.



HAM develops and manufactures tools and tooling-systems for the worldwide market.

HAM – Your competent partner in the precision tool technology

- *solid carbide-, cermet-, ceramic-tools for drilling, countersinking, milling and reaming*
- *carbide-, diamond- and CBN-tools with all modular interfaces as monoblock tools, indexable inserts- and cartridge-tools (adjustable rough and precisely) for drilling and countersinking, for milling and for pre- and precise machining*
- *Project Planning and Project Engineering*
- *worldwide TCM-partner for Tool Management Systems in automotive and aerospace industry and their suppliers*
- *solid carbide drilling- and routing tools for PCB industry*

HAM is certified acc. to DIN EN ISO 9001, VDA 6.4 and DIN EN ISO 13485.

sicher verpackt
safely packed



Die hochwertige Einzelverpackung bietet optimalen Schutz für hochempfindliche Werkzeuge in allen Abmessungen.

The high quality single package offers optimal protection for the sensitive tools in all measurements.

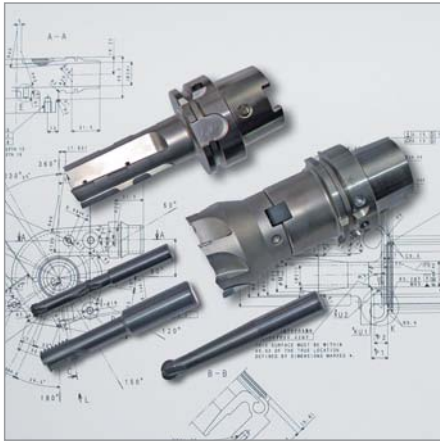

HAM Projektengineering
Partnerschaft vom Projektengineering
bis zum Toolmanagement

HAM Project Engineering
partnership from Project Engineering
to Toolmanagement



HAM Superdrill
Vollhartmetall-Hochleistungsbohrwerkzeuge
für höchste Ansprüche

HAM Superdrill
solid carbide high performance drilling tools
for the highest demands



HAM Nirodrill
Vollhartmetall-Hochleistungsbohrer
für rostfreie Stähle

HAM Nirodrill
solid carbide high performance drills
for stainless steel

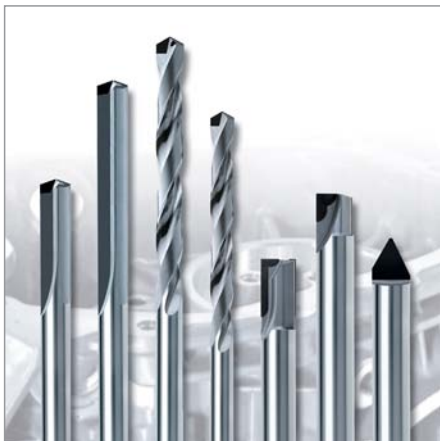

HAM Diamantwerkzeuge
in Sonderausführungen zum Bohren,
Fräsen, Senken und für die Vor- und
Feinstbearbeitung

HAM Diamond Tools
special designs for drilling, milling,
countersinking and for pre- and
precise machining



HAM Moderne Werkstoffe
Standard- und Sonderwerkzeuge
zum Bearbeiten moderner Werkstoffe

HAM Advanced Materials
standard and special tools for
machining of advanced materials



HAM Technologiezentrum
Optimierung von Schnittdaten und
Schneidengeometrie mit Versuchen
an allen Schneidstoffen

HAM Technology Center
optimization of cutting data and
cutting geometry with tests on all
cutting materials



HAM Vollhartmetallfräser
in Feinstkornqualität für Fräsoperationen
in allen Werkstoffen

HAM Solid Carbide End Mills
*in ultra micro grain for milling operations
in all materials*



HAM Diamant-Fräskopf-Systeme
1D- und 2D-Fräskopf-Systeme zum Fräsen
und für die Vor- und Feinstbearbeitung

HAM Diamond Milling Cutter Systems
*1D- and 2D-Milling Cutter Systems for
milling and for pre- and precise machining*



HAM Alu-Cut
Vollhartmetallfräser für Aluminium-
und Kunststoffbearbeitung

HAM Alu-Cut
*solid carbide end mills for machining of
aluminium and plastics*



HAM Micro-Werkzeuge
Vollhartmetall-Spezialbohrer und -fräser
für die Leiterplattenindustrie

HAM Micro Tools
*solid carbide special drills and -routers
for PCB industry*



HAM Spezial-Poliervverfahren
HSF TECHNOLOGY
Poliervverfahren für Werkzeuge mit
spiegelglatten Oberflächen

HAM Special-Polishing Process
HSF TECHNOLOGY
*polishing process for tools with
hyper smooth surfaces*



HAM Kristalltechnologie
Laser- und Präzisionsoptik

HAM Crystal Technology
laser- and high-precision optics

Distributor | Agent | Address



**Hartmetallwerkzeugfabrik
Andreas Maier GmbH**
Stegwiesen 2
D-88477 Schwendi-Hörenhausen
Telefon +49 73 47 / 61-0
Telefax +49 73 47 / 61-142
Bestellungen an /orders to: order@ham-tools.com
www.ham-tools.com



Reg. Nr. 2949 QM



Technische Änderungen unserer Produkte und Änderungen des Lieferprogrammes im Zuge der Weiterentwicklung behalten wir uns vor.
Es gelten unsere Allgemeinen Geschäftsbedingungen unter www.ham-tools.com

*All modifications concerning technical and delivery issues are subject to the course of further development.
Our General Terms and Conditions apply to any product or service, available at www.ham-tools.com*

