

Page 2-11

Rotary Tooling

Page 11-17

Collets

Page 18-27

**Cutting Tools, APKT
Cutters, Parting Tools,
Hole Saws, Carbide Burrs**

Page 28-29

**Grattec
Deburring**

Page 30

Workholding & Jaws

Page 31-32

**Toolholder
Bushings**



BRT-TOOLS

brttools.com





ER/TG COLLET CHUCKS • CAT 40 • 20,000 RPM

PRECISION TOOLS

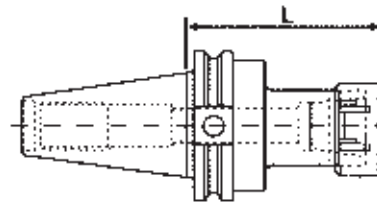
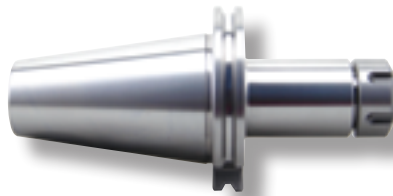

PART NO.	TAPER	DESCRIPTION	COLLET SIZE	GAGE -L	PRICE
BRT-01031125	CAT 40	Collet Chuck	ER11	2.5"	\$61.67
BRT-01031140	CAT 40	Collet Chuck	ER11	4"	66.02
BRT-01031160	CAT 40	Collet Chuck	ER11	6"	82.73
BRT-01031625	CAT 40	Collet Chuck	ER16	2.5"	61.67
BRT-01031640	CAT 40	Collet Chuck	ER16	4"	66.02
BRT-01031660	CAT 40	Collet Chuck	ER16	6"	82.73
BRT-01032025	CAT 40	Collet Chuck	ER20	2.5"	61.67
BRT-01032040	CAT 40	Collet Chuck	ER20	4"	66.02
BRT-01032060	CAT 40	Collet Chuck	ER20	6"	82.73
BRT-01032525	CAT 40	Collet Chuck	ER25	2.5"	61.67
BRT-01032540	CAT 40	Collet Chuck	ER25	4"	66.02
BRT-01032560	CAT 40	Collet Chuck	ER25	6"	82.73
BRT-01033230	CAT 40	Collet Chuck	ER32	3"	61.67
BRT-01033250	CAT 40	Collet Chuck	ER32	5"	74.38
BRT-01033280	CAT 40	Collet Chuck	ER32	8"	82.73
BRT-01034030	CAT 40	Collet Chuck	ER40	3"	61.67
BRT-01034050	CAT 40	Collet Chuck	ER40	5"	74.38
BRT-01TG1003	CAT 40	Collet Chuck	TG100	3.25"	74.38
BRT-01TG1004	CAT 40	Collet Chuck	TG100	4.50"	82.73



See page 7 for Stopscrews with coolant holes. See page 10 for wrenches & nuts. See pages 11-17 for ER Collets.



END MILL HOLDER • CAT 40 • 20,000 RPM

PRECISION TOOLS

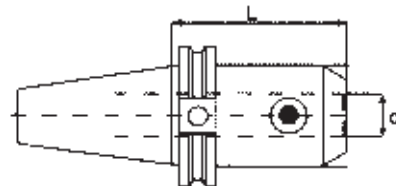

PART NO.	TAPER	DESCRIPTION	HOLE DIA. -D	GAGE -L	PRICE
BRT-01010251	CAT 40	End Mill Holder	1/4"	1.38"	\$66.02
BRT-01010254	CAT 40	End Mill Holder	1/4"	4"	66.02
BRT-01010311	CAT 40	End Mill Holder	5/16"	1.38"	66.02
BRT-01010314	CAT 40	End Mill Holder	5/16"	4"	66.02
BRT-01010371	CAT 40	End Mill Holder	3/8"	1.38"	66.02
BRT-01010374	CAT 40	End Mill Holder	3/8"	4"	66.02
BRT-01010432	CAT 40	End Mill Holder	7/16"	2.5"	66.02
BRT-01010501	CAT 40	End Mill Holder	1/2"	1.75"	66.02
BRT-01010504	CAT 40	End Mill Holder	1/2"	4"	66.02
BRT-01010506	CAT 40	End Mill Holder	1/2"	6"	66.02
BRT-01010621	CAT 40	End Mill Holder	5/8"	1.75"	66.02
BRT-01010623	CAT 40	End Mill Holder	5/8"	3"	66.02
BRT-01010625	CAT 40	End Mill Holder	5/8"	5"	74.38
BRT-01010751	CAT 40	End Mill Holder	3/4"	1.75"	66.02
BRT-01010753	CAT 40	End Mill Holder	3/4"	3"	74.38
BRT-01010873	CAT 40	End Mill Holder	7/8"	3.5"	66.02
BRT-01011002	CAT 40	End Mill Holder	1"	2"	66.02
BRT-01011004	CAT 40	End Mill Holder	1"	4"	66.02
BRT-01011006	CAT 40	End Mill Holder	1"	6"	66.02
BRT-01011252	CAT 40	End Mill Holder	1-1/4"	2"	66.02
BRT-01011254	CAT 40	End Mill Holder	1-1/4"	4"	66.02
BRT-01011256	CAT 40	End Mill Holder	1-1/4"	6"	82.73
BRT-01011504	CAT 40	End Mill Holder	1-1/2"	4.5"	66.02



FACE MILL HOLDER • CAT 40

PRECISION TOOLS

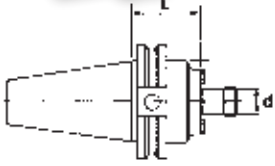

PART NO.	TAPER	DESCRIPTION	HOLE DIA. -D	GAGE -L	PRICE
BRT-01020501	CAT 40	Shell Mill Adapter	1/2"	1.75"	\$57.67
BRT-01020751	CAT 40	Shell Mill Adapter	3/4"	1.75"	57.67
BRT-01020754	CAT 40	Shell Mill Adapter	3/4"	4"	66.02
BRT-01021001	CAT 40	Shell Mill Adapter	1"	1.75"	57.67
BRT-01021004	CAT 40	Shell Mill Adapter	1"	4"	66.02
BRT-01021252	CAT 40	Shell Mill Adapter	1-1/4"	2"	57.67
BRT-01021254	CAT 40	Shell Mill Adapter	1-1/4"	4"	66.02
BRT-01021502	CAT 40	Shell Mill Adapter	1-1/2"	2"	57.67
BRT-01021504	CAT 40	Shell Mill Adapter	1-1/2"	4"	66.02



MORSE TAPER ADAPTER • CAT 40

PRECISION TOOLS

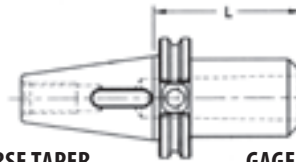

PART NO.	TAPER	DESCRIPTION	MORSE TAPER	GAGE -L	PRICE
BRT-01050202	CAT 40	Morse Taper Adapter	MT 2	2"	\$57.67
BRT-01050303	CAT 40	Morse Taper Adapter	MT 3	3"	57.67
BRT-01050404	CAT 40	Morse Taper Adapter	MT 4	4"	57.67



JACOBS TAPER ADAPTER • CAT 40

PRECISION TOOLS

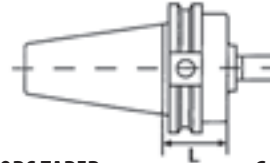

PART NO.	TAPER	DESCRIPTION	JACOBS TAPER	GAGE -L	PRICE
BRT-01040202	CAT 40	Jacobs Adapter	JT #2	2"	\$57.67
BRT-01040302	CAT 40	Jacobs Adapter	JT #3	2"	57.67
BRT-01040402	CAT 40	Jacobs Adapter	JT #4	2"	57.67
BRT-01040602	CAT 40	Jacobs Adapter	JT #6	2"	57.67
BRT-01043302	CAT 40	Jacobs Adapter	JT #33	2"	57.67



HSK 63A COLLET CHUCKS

PRECISION TOOLS

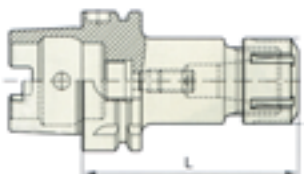

PART NO.	DESCRIPTION	COLLET SIZE	GAGE LENGTH (L)	PRICE
BRT-8881175	HSK63A-ER11-75 Collet Chuck	ER11	75mm (2.95")	\$162.63
BRT-8881100	HSK63A-ER11-100 Collet Chuck	ER11	100mm (3.94")	182.13
BRT-8881675	HSK63A-ER16-75 Collet Chuck	ER16	75mm (2.95")	146.17
BRT-88816160	HSK63A-ER16-160 Collet Chuck	ER16	160mm (6.30")	182.13
BRT-8882075	HSK63A-ER20-75 Collet Chuck	ER20	75mm (2.95")	146.17
BRT-88820160	HSK63A-ER20-160 Collet Chuck	ER20	160mm (6.30")	182.13
BRT-8882575	HSK63A-ER25-75 Collet Chuck	ER25	75mm (2.95")	146.17
BRT-88825160	HSK63A-ER25-160 Collet Chuck	ER25	160mm (6.30")	182.13
BRT-8883275	HSK63A-ER32-75 Collet Chuck	ER32	75mm (2.95")	146.17
BRT-88832160	HSK63A-ER32-160 Collet Chuck	ER32	160mm (6.30")	182.13
BRT-8884090	HSK63A-ER40-90 Collet Chuck	ER40	90mm (3.54")	162.63
BRT-88840160	HSK63A-ER40-160 Collet Chuck	ER40	160mm (6.30")	182.13



ER/TG COLLET CHUCKS • CAT 50 • 15,000 RPM

PRECISION TOOLS

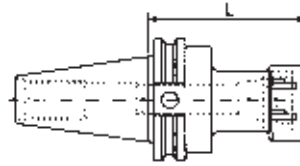
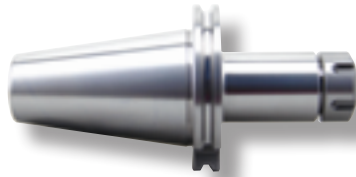

PART NO.	TAPER	DESCRIPTION	COLLET SIZE	GAGE -L	PRICE
BRT-02031640	CAT 50	Collet Chuck	ER16	4"	\$91.10
BRT-02031660	CAT 50	Collet Chuck	ER16	6"	107.80
BRT-02032025	CAT 50	Collet Chuck	ER20	2.5"	91.10
BRT-02032060	CAT 50	Collet Chuck	ER20	6"	107.80
BRT-02032525	CAT 50	Collet Chuck	ER25	2.5"	91.10
BRT-02032540	CAT 50	Collet Chuck	ER25	4"	91.10
BRT-02032560	CAT 50	Collet Chuck	ER25	6"	107.80
BRT-02032580	CAT 50	Collet Chuck	ER25	8"	146.25
BRT-02033240	CAT 50	Collet Chuck	ER32	4"	91.10
BRT-02033260	CAT 50	Collet Chuck	ER32	6"	99.45
BRT-02033280	CAT 50	Collet Chuck	ER32	8"	146.25
BRT-02034040	CAT 50	Collet Chuck	ER40	4"	91.10
BRT-02034060	CAT 50	Collet Chuck	ER40	6"	99.45
BRT-02034080	CAT 50	Collet Chuck	ER40	8"	146.25
BRT-02TG1003	CAT 50	Collet Chuck	TG100	3.25"	116.17
BRT-02TG1005	CAT 50	Collet Chuck	TG100	5.50"	141.23

See pages 11-17 for Collets.



MORSE TAPER ADAPTER • CAT 50

PRECISION TOOLS

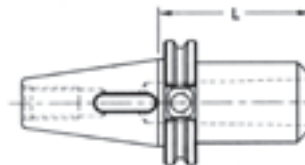

PART NO.	TAPER	DESCRIPTION	MORSE TAPER	GAGE -L	PRICE
BRT-02050202	CAT 50	Morse Taper Adapter	MT 2	2"	\$82.73
BRT-02050302	CAT 50	Morse Taper Adapter	MT 3	2"	82.73
BRT-02050403	CAT 50	Morse Taper Adapter	MT 4	3"	82.73
BRT-02050504	CAT 50	Morse Taper Adapter	MT 5	4"	99.45



JACOBS TAPER ADAPTER • CAT 50

PRECISION TOOLS

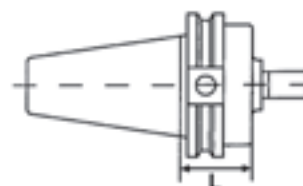

PART NO.	TAPER	DESCRIPTION	HOLE DIA. -D	GAGE -L	PRICE
BRT-02040202	CAT 50	Jacobs Adapter	JT #2	2"	\$78.55
BRT-02040302	CAT 50	Jacobs Adapter	JT #3	2"	78.55
BRT-02040402	CAT 50	Jacobs Adapter	JT #4	2"	78.55
BRT-02040602	CAT 50	Jacobs Adapter	JT #6	2"	78.55
BRT-02043302	CAT 50	Jacobs Adapter	JT #33	2"	78.55



END MILL HOLDER • CAT 50 • 15,000 RPM

PRECISION TOOLS

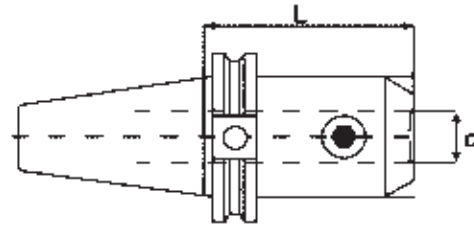
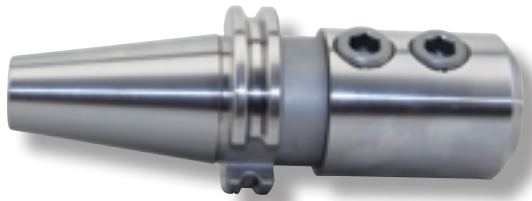

PART NO.	TAPER	DESCRIPTION	HOLE DIA. -D	GAGE -L	PRICE
BRT-02010251	CAT 50	End Mill Holder	1/4"	1.38"	\$99.45
BRT-02010254	CAT 50	End Mill Holder	1/4"	4"	82.73
BRT-02010256	CAT 50	End Mill Holder	1/4"	6"	99.45
BRT-02010312	CAT 50	End Mill Holder	5/16"	2.5"	82.73
BRT-02010314	CAT 50	End Mill Holder	5/16"	4"	82.73
BRT-02010371	CAT 50	End Mill Holder	3/8"	1.38"	99.45
BRT-02010374	CAT 50	End Mill Holder	3/8"	4"	82.73
BRT-02010376	CAT 50	End Mill Holder	3/8"	6"	99.45
BRT-02010432	CAT 50	End Mill Holder	7/16"	2.5"	82.73
BRT-02010501	CAT 50	End Mill Holder	1/2"	1.75"	82.73
BRT-02010504	CAT 50	End Mill Holder	1/2"	4"	82.73
BRT-02010506	CAT 50	End Mill Holder	1/2"	6"	99.45
BRT-02010621	CAT 50	End Mill Holder	5/8"	1.75"	82.73
BRT-02010624	CAT 50	End Mill Holder	5/8"	4"	82.73
BRT-02010626	CAT 50	End Mill Holder	5/8"	6"	99.45
BRT-02010751	CAT 50	End Mill Holder	3/4"	1.75"	82.73
BRT-02010754	CAT 50	End Mill Holder	3/4"	4"	82.73
BRT-02010756	CAT 50	End Mill Holder	3/4"	6"	99.45
BRT-02018753	CAT 50	End Mill Holder	7/8"	3.75"	82.73
BRT-02011002	CAT 50	End Mill Holder	1"	2"	99.45
BRT-02011004	CAT 50	End Mill Holder	1"	4"	99.45
BRT-02011006	CAT 50	End Mill Holder	1"	6"	107.80
BRT-02011008	CAT 50	End Mill Holder	1"	8"	149.60
BRT-02011252	CAT 50	End Mill Holder	1-1/4"	2"	99.45
BRT-02011254	CAT 50	End Mill Holder	1-1/4"	4"	99.45
BRT-02011256	CAT 50	End Mill Holder	1-1/4"	6"	107.80
BRT-02011258	CAT 50	End Mill Holder	1-1/4"	8"	149.60
BRT-02011502	CAT 50	End Mill Holder	1-1/2"	2.25"	99.45
BRT-02011504	CAT 50	End Mill Holder	1-1/2"	4.5"	99.45
BRT-02011508	CAT 50	End Mill Holder	1-1/2"	8"	149.60
BRT-02012005	CAT 50	End Mill Holder	2"	5.37"	107.80



KEYLESS DRILL CHUCKS

PRECISION TOOLS



- Precision Tested
- For General Machining Condition
- All hardened parts
- Use with CAT or BT Holders

Part No.	Clamping Range	Mount	Price
BRT-DR110J33	1/32" - 3/8" (1-10 mm)	J33	\$41.70
BRT-DR113J33	1/32" - 1/2" (1-13 mm)	J33	45.05
BRT-DR116J6	1/32" - 5/8" (1-16 mm)	J6	52.57
BRT-DR120J3	3/16" - 3/4" (1-20 mm)	J3	58.45



INTEGRAL KEYLESS DRILL CHUCKS

ANSI B5.50

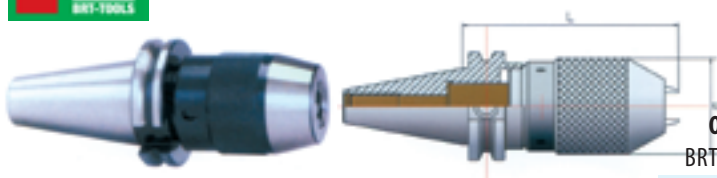

Wrench for Above

Order No.	Description	Price
BRT-04SPDR13	For 1-13mm Chuck	\$11.39
BRT-04SPDR16	For 3-16mm Chuck	11.39

Order No.	Model	Clamping Range	D	L-Gage Length	Price
BRT-0440DR13	CAT40-APU13	1-13	51.5	100 mm	\$166.30
BRT-0440DR16	CAT40-APU16	3-16	58	110 mm	166.30
BRT-0450DR16	CAT50-APU13	3-16	58	105 mm	249.88



FACE MILL HOLDER • CAT 50

PRECISION TOOLS

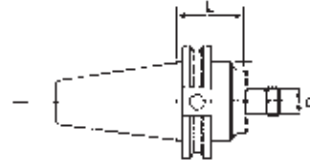

PART NO.	TAPER	DESCRIPTION	ARBOR -d	GAGE -L	PRICE
BRT-02020751	CAT 50	Shell Mill Adapter	3/4"	1.75"	\$107.80
BRT-02020754	CAT 50	Shell Mill Adapter	3/4"	4"	107.80
BRT-02020756	CAT 50	Shell Mill Adapter	3/4"	6"	116.17
BRT-02020758	CAT 50	Shell Mill Adapter	3/4"	8"	146.25
BRT-02021001	CAT 50	Shell Mill Adapter	1"	1.75"	107.80
BRT-02021004	CAT 50	Shell Mill Adapter	1"	4"	107.80
BRT-02021006	CAT 50	Shell Mill Adapter	1"	6"	116.17
BRT-02021008	CAT 50	Shell Mill Adapter	1"	8"	146.25
BRT-02021251	CAT 50	Shell Mill Adapter	1-1/4"	1.75"	107.80
BRT-02021254	CAT 50	Shell Mill Adapter	1-1/4"	4"	116.17
BRT-02021256	CAT 50	Shell Mill Adapter	1-1/4"	6"	132.88
BRT-02021258	CAT 50	Shell Mill Adapter	1-1/4"	8"	154.60
BRT-02021502	CAT 50	Shell Mill Adapter	1-1/2"	2"	107.80
BRT-02021504	CAT 50	Shell Mill Adapter	1-1/2"	4"	116.17
BRT-02021506	CAT 50	Shell Mill Adapter	1-1/2"	6"	132.88
BRT-02021508	CAT 50	Shell Mill Adapter	1-1/2"	8"	154.60
BRT-02022002	CAT 50	Shell Mill Adapter	2"	2"	116.17
BRT-02022004	CAT 50	Shell Mill Adapter	2"	4"	124.52
BRT-02022006	CAT 50	Shell Mill Adapter	2"	6"	132.88



DUAL CONTACT COLLET CHUCKS • CAT 40

PRECISION TOOLS

DUAL CONTACT - Balanced to 25,000 RPM

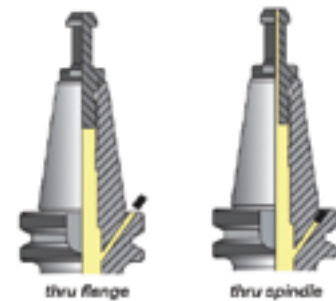
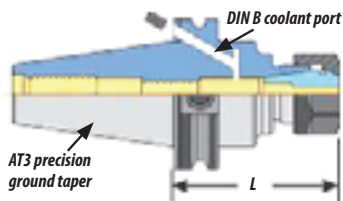

PART NO.	TAPER	DESCRIPTION	COLLET SIZE	GAGE -L	AD/B	PRICE
BRT-07031627	CAT 40	Dual Contact	ER16	2.76"		\$116.17
BRT-07031640	CAT 40	Dual Contact	ER16	4.00"		124.52
BRT-07031660	CAT 40	Dual Contact	ER16	6.00"		141.23
BRT-07033227	CAT 40	Dual Contact	ER32	2.76"		116.17
BRT-07033240	CAT 40	Dual Contact	ER32	4.00"		124.52
BRT-07033260	CAT 40	Dual Contact	ER32	6.00"		141.23
BRT-07034031	CAT 40	Dual Contact	ER40	3.15"		124.52

See pages 11-17 for ER Collets.



STOP SCREWS w/coolant hole (for ER Collet Chucks)

PRECISION TOOLS



Part No.

Description

Price (each)

BRT-10111SS	ER11 STOPSCREW W/COOLANT HOLE - M6	\$2.68
BRT-10116SS	ER16 STOPSCREW W/COOLANT HOLE - M10	2.68
BRT-10120SS	ER20 STOPSCREW W/COOLANT HOLE - M14	2.68
BRT-10125SS	ER25 STOPSCREW W/COOLANT HOLE - M18	3.14
BRT-10132SS	ER32 STOPSCREW W/COOLANT HOLE - M22	3.30
BRT-10140SS	ER40 STOPSCREW W/COOLANT HOLE - M28	3.80



STRAIGHT SHANK MINI COLLET CHUCK

PRECISION TOOLS



Mini Nut

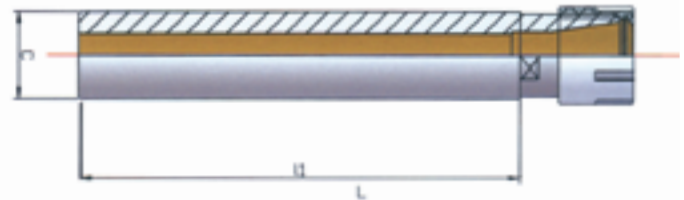

PART NO.	COLLET SIZE	NUT DIAMETER	SHANK - C	GAGE - L1	PRICE
BRT-0611M-4	ER 11	.630"	1/2"	4.00"	\$49.30
BRT-0611M-6	ER 11	.630"	1/2"	6.00"	54.32
BRT-0616M-4	ER 16	.865"	1/2"	4.00"	54.32
BRT-0616M-6	ER 16	.865"	1/2"	6.00"	57.67
Mini Nuts					
BRT-101MN11	ER 11	.630"	-	-	11.58
BRT-101MN16	ER 16	.865"	-	-	11.58

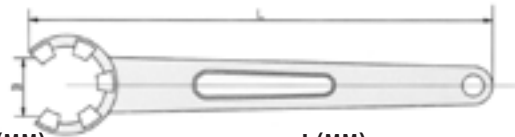

PART NO.	NUT	B(MM)	L(MM)	PRICE
BRT-10111ERM	11ER-M	11	90	\$16.37
BRT-10116ERM	16ER-M	15	110	16.37



STRAIGHT SHANK COLLET CHUCK

PRECISION TOOLS

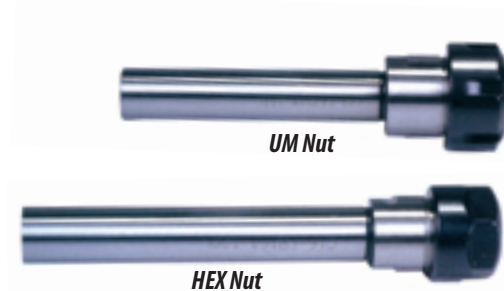

UM Nut

HEX Nut

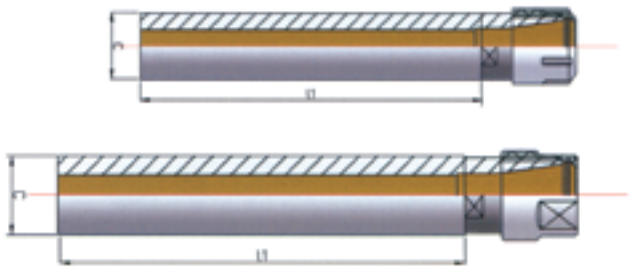

PART NO.	COLLET SIZE	NUT	SHANK - C	GAGE - L1	PRICE
BRT-06111235	ER 11	HEX	1/2"	3.5"	\$57.67
BRT-06111260	ER 11	HEX	1/2"	6.0"	57.67
BRT-06163440	ER 16	UM	3/4"	4.0"	57.67
BRT-06163460	ER 16	UM	3/4"	6.0"	65.18
BRT-06203440	ER20	UM	3/4"	4.0"	57.67
BRT-06203460	ER 20	UM	3/4"	6.0"	65.18
BRT-06253440	ER 25	UM	3/4"	4.0"	66.02
BRT-06251060	ER 25	UM	1.0"	6.0"	82.73
BRT-06321040	ER 32	UM	1.0"	4.0"	82.73
BRT-06321060	ER 32	UM	1-1/4"	6.0"	82.73



PRECISION MILLING CHUCK KITS

PRECISION TOOLS

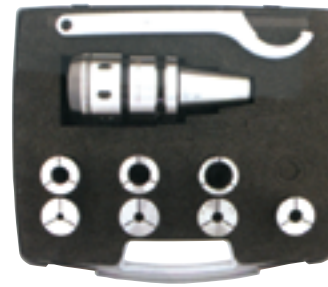

CAT 40 - SC3/4 KIT

- CAT 40 - 3/4 Milling Chuck
 - SC 3/4 - 1/4 Collet
 - SC 3/4 - 5/16 Collet
 - SC 3/4 - 3/8 Collet
 - SC 3/4 - 7/16 Collet
 - SC 3/4 - 1/2 Collet
 - SC 3/4 - 9/16 Collet
 - SC 3/4 - 5/8 Collet
 - Wrench
 - Aluminum Case
- BRT-034034KT**

\$263.²⁵

CAT 40 - SC1-1/4 KIT

- CAT 40 1-1/4 Milling Chuck
 - SC 1-1/4 - 3/8 Collet
 - SC 1-1/4 - 7/16 Collet
 - SC 1-1/4 - 1/2 Collet
 - SC 1-1/4 - 9/16 Collet
 - SC 1-1/4 - 5/8 Collet
 - SC 1-1/4 - 3/4 Collet
 - SC 1-1/4 - 1 Collet
 - Wrench
 - Aluminum Case
- BRT-034014KT**

\$274.⁹⁵

CAT 50 - SC3/4 KIT

- CAT 50 - 3/4 Milling Chuck
 - SC 3/4 - 1/4 Collet
 - SC 3/4 - 5/16 Collet
 - SC 3/4 - 3/8 Collet
 - SC 3/4 - 7/16 Collet
 - SC 3/4 - 1/2 Collet
 - SC 3/4 - 9/16 Collet
 - SC 3/4 - 5/8 Collet
 - Wrench
 - Aluminum Case
- BRT-035034KT**

\$317.⁰⁷

CAT 50 - SC1-1/4 KIT

- CAT 50 1-1/4 Milling Chuck
 - SC 1-1/4 - 3/8 Collet
 - SC 1-1/4 - 7/16 Collet
 - SC 1-1/4 - 1/2 Collet
 - SC 1-1/4 - 9/16 Collet
 - SC 1-1/4 - 5/8 Collet
 - SC 1-1/4 - 3/4 Collet
 - SC 1-1/4 - 1 Collet
 - Wrench
 - Aluminum Case
- BRT-035014KT**

\$329.⁹⁴



BRT MILLING COLLETS

PRECISION TOOLS

INCH	SC 1/2"	PRICE	SC 3/4"	PRICE	SC 1-1/4"	PRICE
1/8"	BRT-035018	\$33.35	BRT-033418	\$22.48	-	-
3/16"	BRT-0350316	33.35	BRT-0334316	22.48	BRT-03114316	\$26.66
1/4"	BRT-035014	33.35	BRT-033414	22.48	BRT-0311414	26.66
5/16"	BRT-0350516	33.35	BRT-0334516	22.48	BRT-03114516	26.66
3/8"	BRT-035038	33.35	BRT-033438	22.48	BRT-0311418	26.66
7/16"	-	-	BRT-0334716	22.48	BRT-03114716	26.66
1/2"	-	-	BRT-033412	22.48	BRT-0311412	26.66
9/16"	-	-	BRT-0334916	22.48	BRT-03114916	26.66
5/8"	-	-	BRT-033458	22.48	BRT-0311458	26.66
3/4"	-	-	-	-	BRT-0311434	26.66
7/8"	-	-	-	-	BRT-0311478	26.66
1"	-	-	-	-	BRT-031141	26.66
METRIC	SC 1/2"	PRICE	SC 3/4"	PRICE	SC 1-1/4"	PRICE
3 mm	BRT-0350.3	\$33.35	-	-	-	-
4 mm	BRT-0350.4	33.35	-	-	-	-
6 mm	BRT-0350.6	33.35	BRT-0334.6	\$22.48	BRT-03114.6	\$26.66
8 mm	BRT-0350.8	33.35	BRT-0334.8	22.48	BRT-03114.8	26.66
10 mm	BRT-0350.10	33.35	BRT-0334.10	22.48	BRT-03114.10	26.66
12 mm	-	-	BRT-0334.12	22.48	BRT-03114.12	26.66
14 mm	-	-	BRT-0334.14	22.48	BRT-03114.14	26.66
16 mm	-	-	BRT-0334.16	22.48	BRT-03114.16	26.66
20 mm	-	-	-	-	BRT-03114.20	26.66
25 mm	-	-	-	-	BRT-03114.25	26.66





SYNCHRO ER TAPPING CHUCK

PRECISION TOOLS



PART NO.	TAPER	SIZE	RANGE	GAGE -L1	NOSE DIA.	PRICE
BRT-SYCT4032	CAT 40	ER 32	#6 - 13/16" (M3-M20)	100 mm	50 mm	\$349.83
BRT-SYCT5032	CAT 50	ER 32	#6 - 13/16" (M3-M20)	100 mm	50 mm	\$403.65

For ER32 TAP Collets see page 15



Quick Change Tapping Chuck with Tension Compression

DIN 69871

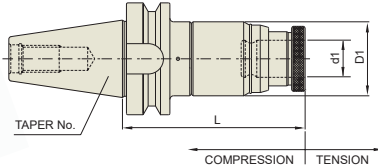

Order No.	Model	D	H-Gage Length	Price
BRT-044001	CAT 40 #1 T/C	45 mm	115 mm	\$183.02
BRT-044002	CAT 40 #2 T/C	63 mm	164 mm	208.93
BRT-045001	CAT 50 #1 T/C	45 mm	115 mm	249.88
BRT-045002	CAT 50 #2 T/C	63 mm	148 mm	283.30
BRT-045003	CAT 50 #3 T/C	98 mm	197 mm	396.97

* For Quick Change Tap Adaptors - see Page 10 *



Quick Change Tapping Chuck with Tension Compression

DIN 69871



Order No.	Model	Shank	Price
BRT-040101	#1 T/C	1"	\$222.30
BRT-040102	#2 T/C	1"	222.30
BRT-0411402	#2 T/C	1-1/4"	222.30



ER COLLET WRENCHES & NUTS

Hex Nut



Part No.	Description	Thread	PRICE
BRT-101011A	ER11 Hex Nut	M14 X 0.75	\$10.27
BRT-101016A	ER16 Hex Nut	M22 X 1.5	12.45
BRT-101020A	ER20 Hex Nut	M25 X 1.5	13.63
BRT-101025A	ER25 Hex Nut	M32 X 1.5	14.80
BRT-101032A	ER32 Hex Nut	M40 X 1.5	15.68

Hex Wrench

Part No.	Description	Price
BRT-1011110A	ER 11 Hex Wrench	\$19.16
BRT-1011160A	ER 16 Hex Wrench	20.60
BRT-1011200A	ER 20 Hex Wrench	21.88
BRT-1011250A	ER 25 Hex Wrench	22.70
BRT-1011320A	ER 32 Hex Wrench	23.28



UM Collet Nut



Part No.	Model	Thread	PRICE
BRT-10101600	ER16-UM	M22 X 1.5	\$10.27
BRT-10102000	ER20-UM	M25 X 1.5	12.45
BRT-10102500	ER25-UM	M32 X 1.5	12.45
BRT-10103200	ER32-UM	M40 X 1.5	14.12
BRT-10104000	ER40-UM	M50 X 1.5	15.80

UM Wrench

Part No.	For Clamping Nut	PRICE
BRT-10111600	ER16-UM	\$13.33
BRT-10112000	ER20-UM	14.17
BRT-10112500	ER25-UM	17.21
BRT-10113200	ER32-UM	21.11
BRT-10114000	ER40-UM	25.87



Bearing Nuts



Part No.	Description	Thread	PRICE
BRT-101B16HX	ER16-HEX	M22 X 1.5	\$26.68
BRT-101B20HX	ER20-HEX	M25 X 1.5	26.68
BRT-101B25UM	ER25-UM	M32 X 1.5	29.19
BRT-101B32UM	ER32-UM	M40 X 1.5	31.71
BRT-101B40UM	ER40-UM	M50 X 1.5	35.04

TG100 Collet Nut

Part No.	Description	Thread	PRICE
BRT-10TG10NT	TG100 Collet Nut	1.875 - 12	\$35.86



TG100 Wrench

Part No.	Model	PRICE
BRT-10TG100	TG100	\$15.87





QUICK CHANGE TAP ADAPTORS

PRECISION TOOLS



ANSI Rigid Tap Adaptors

- Change worn taps in seconds
- Quick-Change Style

				SALE PRICE	\$29.59	\$41.62	\$83.08
ANSI	METRIC TAP / ANSI SHANK	SHANK	SQ	SIZE 1	SIZE 2	SIZE 3	
0-6"	M1.6-M3.5	0.141"	0.110"	BRT-0412001	-	-	
8, 5/32"	M4	0.168"	0.131"	BRT-0412002	-	-	
10, 3/16"	M4.5, M5	0.194"	0.152"	BRT-0412003	-	-	
12, 7/32"	-	0.220"	0.165"	BRT-0412004	-	-	
1/4"	M6, M6.3	0.255"	0.191"	BRT-0412005	-	-	
5/16"	M7, M8	0.318"	0.238"	BRT-0412006	BRT-0424001	-	
3/8"	M10	0.381"	0.286"	BRT-0412007	BRT-0424002	-	
7/16"	M11	0.323"	0.242"	BRT-0412008	BRT-0424003	-	
1/2"	M12, M12.5	0.367"	0.275"	BRT-0412009	BRT-0424004	-	
9/16"	M14	0.429"	0.322"	BRT-0412010	BRT-0424005	-	
5/8"	M16	0.480"	0.360"	-	BRT-0424006	-	
11/16"	M18	0.542"	0.406"	-	BRT-0424007	-	
3/4"	-	0.590"	0.442"	-	BRT-0424008	-	
13/16"	M20	0.652"	0.489"	-	BRT-0424009	BRT-0432001	
7/8"	M22	0.697"	0.523"	-	BRT-0424010	BRT-0432002	
15/16"	M24	0.760"	0.570"	-	-	BRT-0432003	
1"	M25	0.800"	0.600"	-	-	BRT-0432004	
1-1/8, 1-1/16"	M27	0.896"	0.672"	-	-	BRT-0432005	
1-1/4, 1-3/16"	M30	1.021"	0.766"	-	-	BRT-0432006	
1 3/8, 1-5/16"	M33	1.108"	0.831"	-	-	BRT-0432007	
1/8" NPT	-	0.437"	0.328"	BRT-0412012	-	-	
1/4" NPT	-	0.562"	0.421"	-	BRT-0424011	-	
3/8" NPT	-	0.700"	0.531"	-	BRT-0424012	-	
1/2" NPT	-	0.687"	0.515"	-	BRT-0424013	BRT-0432008	
3/4" NPT	-	0.906"	0.678"	-	-	BRT-0432009	
1" NPT	-	1.125"	0.843"	-	-	BRT-0432010	



TOOL HOLDER LOCKING DEVICE & TIGHTENING FIXTURE

PRECISION TOOLS



Order No.
BRT-106C40LD
BRT-106C50LD

Taper
of Tool Holder
CAT40
CAT50

Price
\$91.10
132.88



TIGHTENING FIXTURE
BRT-106C40TF
- Fits CAT40 / HSK63A / BT40
- Multi-Position Setting
- Heavy Duty Construction
Price \$246.53



HEAVY DUTY TOOLSTANDS

PRECISION TOOLS



PART NUMBER	DESCRIPTION	PRICE
BRT-106C40TS	CAT40 12 POCKETS	\$107.80
BRT-106C50TS	CAT50 8 POCKETS	107.80



PULL STUD WRENCH



Part No.	Model	Opening	Price
BRT-PSWC40	CAT 40	0.748"	\$66.11
BRT-PSWC50	CAT 50	1.260"	74.38
BRT-PSWB40	BT 40	0.748"	48.39
BRT-PSWB50	BT 50/CAT 50	1.181"	66.02
BRT-PSWKIT	4 Pc. SET	-	225.65

(Kit includes 4 Wrenches in Case)



BRT PULL STUDS

- Material is 20CrNiMo Certified
- Tolerance exceeds Industry Standards
- Finish is 32 Micro or better
- Hardened for maximum longevity



BRT PART NO.	COOLANT THROUGH	TJD NO.	PARLEC NO.	STM	PRICE (ea.)
CAT 40					
BRT-C400001	Yes	PSC-532X45	4009TRKC	366-058	\$16.38
BRT-C400002	Yes	PSC-474	-	366-038	15.29
BRT-C400003	Yes	PSC-475	40TRK	366-040	14.04
BRT-C400004	No	PS-532X45	4009TRK	366-050	15.05
BRT-C400005	Yes	PSC-572X15	-	-	16.38
BRT-C400006	Yes	PSC-470X15	4030TRK	366-034	16.26
BRT-C400007	No	PS-475	40NTRK	366-042	16.26
BRT-C400008	No	PS-532X60	4014TRK	366-052	16.26
BRT-C400009	Yes	PSC-532X60	4014TRKC	366-060	16.26
CAT 50					
BRT-C500001	Yes	PSC-270X15	-	-	\$25.87
BRT-C500002	Yes	PSC-536X45	5005TRKC	366-104	23.32
BRT-C500003	No	PS-536X60	5014TRK	366-100	23.32
BRT-C500004	Yes	PSC-271X15	-	-	25.87
BRT-C500005	Yes	PSC-273	-	-	23.32
BRT-C500006	Yes	PSC-274	M50TRK	366-094	23.28
BRT-C500007	Yes	PSC-275	50TRK	366-096	23.28
BRT-C500008	Yes	PSC-536X60	5014TRKC	366-106	23.31
BT 30					
BRT-B300001	Yes	PSC-585X45	-	-	\$16.63
BRT-B300002	No	PS-585X45	3003TRK	366-000	16.63
BT 40					
BRT-B400001	Yes	PSC-444X15	P329-15	-	\$16.63
BRT-B400002	No	PSC-444X45	4003TRKC	366-012	16.63



ER11 COLLETS

PRECISION TOOLS

Maximum Contact Surface Area: Each BRT-TOOLS ER Collet features 16 full length slits (instead of competition's 8), enabling the collet to collapse uniformly to provide a concentric and full 360° gripping surface.

Material: Premium Grade Special Alloy Steel with a high modulus of elasticity. Combined with the 16-slit design, this material provides full surface contact on the tool when collapsed. Hardness: 44-48 HRC

Inch and Metric Sizes: Choice of Inch and Metric sizes optimizes contact surface area for ultra high precision applications.



\$12.18



Ultra Precision Standard ER11 Collets

Part No.	Description	Holding Capacity			
		Metric	Inch	Metric	Inch
BRT-105111.0	ER11 Collet-10	0.5	1.0	0.020	0.039
BRT-105111.5	ER11 Collet-15	1.0	1.5	0.039	0.059
BRT-105112.0	ER11 Collet-20	1.5	2.0	0.059	0.079
BRT-105112.4	ER11 Collet-24	3/32"	0.074	0.094	
BRT-105112.5	ER11 Collet-25	2.0	2.5	0.079	0.098
BRT-105113.0	ER11 Collet-30	2.5	3.0	0.098	0.118
BRT-105113.2	ER11 Collet-32	1/8"	0.105	0.125	
BRT-105113.5	ER11 Collet-35	3.0	3.5	0.118	0.138
BRT-105114.0	ER11 Collet-40	3.5	4.0	0.138	0.157
BRT-105114.5	ER11 Collet-45	4.0	4.5	0.157	0.177
BRT-105114.8	ER11 Collet-48	3/16"	0.168	0.188	
BRT-105115.0	ER11 Collet-50	4.5	5.0	0.177	0.197
BRT-105115.5	ER11 Collet-55	5.0	5.5	0.197	0.217
BRT-105116.0	ER11 Collet-60	5.5	6.0	0.217	0.236
BRT-105116.4	ER11 Collet-64	1/4"	0.230	0.250	
BRT-105116.5	ER11 Collet-65	6.0	6.5	0.236	0.256
BRT-105117.0	ER11 Collet-70	6.5	7.0	0.256	0.276

SETS

ULTRA PRECISION ER COLLET SETS: DIN6499B

Ultra Precision ER11 Collets - SET - Inch

Part No.	Description
BRT-1051109I	ER11 Collet Set 9 pc. (1/32"-9/32")

All Sets in an Plastic Case. (not exactly as pictured)

\$107.80

Ultra Precision ER11 Collets - SET - Metric

Part No.	Description
BRT-1051113	ER11 Collet Set 13 pc. (1-7)

All Sets in an Aluminum Case. (not exactly as pictured)

\$121.18



\$11.68

Ultra Precision Standard ER16 Collets

Part No.	Description	Holding Capacity			
		Metric		Inch	
BRT-105161.0	ER16 Collet-10	0.5	1.0	0.020	0.039
BRT-105161.5	ER16 Collet-15	1.0	1.5	0.039	0.059
BRT-105162.0	ER16 Collet-20	1.5	2.0	0.059	0.079
BRT-105162.4	ER16 Collet-24	3/32"		0.074	0.094
BRT-105162.5	ER16 Collet-25	1.5	2.5	0.059	0.098
BRT-105163.0	ER16 Collet-30	2.0	3.0	0.079	0.118
BRT-105163.2	ER16 Collet-32	1/8"		0.087	0.125
BRT-105164.0	ER16 Collet-40	3.0	4.0	0.118	0.157
BRT-105164.8	ER16 Collet-48	3/16"		0.150	0.188
BRT-105165.0	ER16 Collet-50	4.0	5.0	0.157	0.197
BRT-105166.0	ER16 Collet-60	5.0	6.0	0.197	0.236
BRT-105166.4	ER16 Collet-64	1/4"		0.213	0.250
BRT-105167.0	ER16 Collet-70	6.0	7.0	0.236	0.276
BRT-105168.0	ER16 Collet-80	7.0	8.0	0.276	0.315
BRT-105169.0	ER16 Collet-90	8.0	9.0	0.315	0.354
BRT-105169.5	ER16 Collet-95	3/8"		0.335	0.375
BRT-1051610	ER16 Collet-100	9.0	10.0	0.354	0.394



\$29.17

Steel Sealed ER16 Collets

Part No.	Description	Holding Capacity			
		Metric		Inch	
BRT-SS5163.0	ER16SS Collet-30	2.0	3.0	0.079	0.118
BRT-SS5163.2	ER16SS Collet-32	1/8"		0.087	0.125
BRT-SS5164.0	ER16SS Collet-40	3.0	4.0	0.118	0.157
BRT-SS5164.8	ER16SS Collet-48	3/16"		0.150	0.188
BRT-SS5165.0	ER16SS Collet-50	4.0	5.0	0.157	0.197
BRT-SS5166.0	ER16SS Collet-60	5.0	6.0	0.197	0.236
BRT-SS5166.4	ER16SS Collet-64	1/4"		0.213	0.250
BRT-SS5167.0	ER16SS Collet-70	6.0	7.0	0.236	0.276
BRT-SS5168.0	ER16SS Collet-80	7.0	8.0	0.276	0.315
BRT-SS5169.0	ER16SS Collet-90	8.0	9.0	0.315	0.354
BRT-SS5169.5	ER16SS Collet-95	3/8"		0.335	0.375
BRT-SS51610	ER16SS Collet-100	9.0	10.0	0.354	0.394

SETS



ULTRA PRECISION ER COLLET SETS: DIN6499B

Ultra Precision ER16 Collets - SET - Inch

Part No. Description
 BRT-1051610I ER16 Collet Set 10 pc. (1/32"-3/8")
All Sets in an Plastic Case. (not exactly as pictured)

\$99.45

Ultra Precision ER16 Collets - SET - Metric

Part No. Description
 BRT-1051610 ER16 Collet Set 10 pc. (1-10)
All Sets in an Aluminum Case. (not exactly as pictured)

\$91.10

STEEL SEALED ER16 COLLET SET: DIN6499

Part No. Description
 BRT-SS51608S ER16SS Steel Sealed Collet Set (3-10) 8 pc.
All Sets in an Aluminum Case. (not exactly as pictured)

\$262.42

ER16 Tap Collets (ANSI)

\$24.98

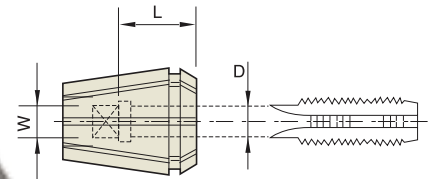

TAP	Part No.	Inch	Metric	D(φ)	W(□)	L
	BRT-TC516411	#6	M3	0.141	0.110	0.709
	BRT-TC516613	#8	M4	0.168	0.131	0.709
	BRT-TC516915	#10	M4.5+M5	0.194	0.152	0.709
	BRT-TC516216	#12	-	0.220	0.165	0.709
	BRT-TC516519	1/4	M6	0.255	0.191	0.709
	BRT-TC516123	5/16	M7+M8	0.318	0.238	0.709
	BRT-TC516224	7/16	-	0.323	0.242	0.709
PIPE TAP	BRT-TCP16123	1/8"SS	-	0.312	0.234	0.709
	BRT-TCP16332	1/8"LS	-	0.437	0.328	0.709



\$11.68

Ultra Precision Standard ER20 Collets

Part No.	Description	Holding Capacity			
		Metric	Inch	Metric	Inch
BRT-105201.5	ER20 Collet-15	1.0	1.5	0.039	0.059
BRT-105202.0	ER20 Collet-20	1.5	2.0	0.059	0.079
BRT-105202.4	ER20 Collet-24	3/32"	0.074	0.094	
BRT-105203.0	ER20 Collet-30	2.0	3.0	0.079	0.118
BRT-105203.2	ER20 Collet-32	1/8"	0.087	0.125	
BRT-105204.0	ER20 Collet-40	3.0	4.0	0.118	0.157
BRT-105204.8	ER20 Collet-48	3/16"	0.150	0.188	
BRT-105205.0	ER20 Collet-50	4.0	5.0	0.157	0.197
BRT-105206.0	ER20 Collet-60	5.0	6.0	0.197	0.236
BRT-105206.4	ER20 Collet-64	1/4"	0.213	0.250	
BRT-105207.0	ER20 Collet-70	6.0	7.0	0.236	0.276
BRT-105208.0	ER20 Collet-80	7.0	8.0	0.276	0.315
BRT-105209.0	ER20 Collet-90	8.0	9.0	0.315	0.354
BRT-105209.5	ER20 Collet-95	3/8"	0.335	0.375	
BRT-1052010	ER20 Collet-100	9.0	10.0	0.354	0.394
BRT-1052011	ER20 Collet-110	10.0	11.0	0.394	0.433
BRT-1052012.	ER20 Collet-120	11.0	12.0	0.433	0.472
BRT-10520127	ER20 Collet-127	1/2"	0.461	0.500	
BRT-1052013	ER20 Collet-130	12.0	13.0	0.472	0.512



\$30.00

Steel Sealed ER20 Collets

Part No.	Description	Holding Capacity			
		Metric	Inch	Metric	Inch
BRT-SS5203.0	ER20SS Collet-30	2.0	3.0	0.079	0.118
BRT-SS5203.2	ER20SS Collet-32	1/8"	0.087	0.125	
BRT-SS5204.0	ER20SS Collet-40	3.0	4.0	0.118	0.157
BRT-SS5204.8	ER20SS Collet-48	3/16"	0.150	0.188	
BRT-SS5205.0	ER20SS Collet-50	4.0	5.0	0.157	0.197
BRT-SS5206.0	ER20SS Collet-60	5.0	6.0	0.197	0.236
BRT-SS5206.4	ER20SS Collet-64	1/4"	0.213	0.250	
BRT-SS5207.0	ER20SS Collet-70	6.0	7.0	0.236	0.276
BRT-SS5208.0	ER20SS Collet-80	7.0	8.0	0.276	0.315
BRT-SS5209.0	ER20SS Collet-90	8.0	9.0	0.315	0.354
BRT-SS5209.5	ER20SS Collet-95	3/8"	0.335	0.375	
BRT-SS52010	ER20SS Collet-100	9.0	10.0	0.354	0.394
BRT-SS52011	ER20SS Collet-110	10.0	11.0	0.394	0.433
BRT-SS52012	ER20SS Collet-120	11.0	12.0	0.433	0.472
BRT-SS520127	ER20SS Collet-127	1/2"	0.461	0.500	
BRT-SS52013	ER20SS Collet-130	12.0	13.0	0.472	0.512

SETS



ULTRA PRECISION ER COLLET SETS: DIN6499B

Ultra Precision ER20 Collets - SET - Inch

Part No.	Description
BRT-1052012I	ER20 Collet Set 12 pc. (1/16"-1/2")

All Sets in an Plastic Case. (not exactly as pictured)

\$116.17

Ultra Precision ER20 Collets - SET - Metric

Part No.	Description
BRT-1052012	ER20 Collet Set 12 pc. (2-13)

All Sets in an Aluminum Case. (not exactly as pictured)

\$107.80

STEEL SEALED ER20 COLLET SET: DIN6499

Part No.	Description
BRT-SS52011S	ER20SS Steel Sealed Collet Set (3-13) 11 pc.

All Sets in an Aluminum Case. (not exactly as pictured)

\$274.95

ER20 Tap Collets (ANSI)

\$24.98

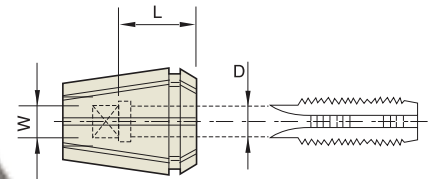

TAP	Part No.	Inch	Metric	D(φ)	W(□)	L
	BRT-TC520411	#6	M3	0.141	0.110	0.709
	BRT-TC520613	#8	M4	0.168	0.131	0.709
	BRT-TC520915	#10	M4.5+M5	0.194	0.152	0.709
	BRT-TC520216	#12	-	0.220	0.165	0.709
	BRT-TC520519	1/4	M6	0.255	0.191	0.709
	BRT-TC520123	5/16	M7+M8	0.318	0.238	0.866
	BRT-TC520622	3/8	M10	0.367	0.275	0.866
	BRT-TC520224	7/16	-	0.323	0.242	0.866
	BRT-TC520828	1/2	M12	0.381	0.286	0.866
PIPE TAP	BRT-TCP20123	1/8"SS	-	0.312	0.234	0.787
	BRT-TCP20332	1/8"LS	-	0.437	0.328	0.787



ER25 COLLETS

PRECISION TOOLS



\$12.18

Ultra Precision Standard ER25 Collets

Part No.	Description	Holding Capacity			
		Metric		Inch	
BRT-105251.0	ER25 Collet-10	0.5	1.0	0.020	0.039
BRT-105251.5	ER25 Collet-15	1.0	1.5	0.039	0.059
BRT-105252.0	ER25 Collet-20	1.5	2.0	0.059	0.079
BRT-105252.4	ER25 Collet-24	3/32"		0.075	0.094
BRT-105253.0	ER25 Collet-30	2.0	3.0	0.079	0.118
BRT-105253.2	ER25 Collet-32	1/8"		0.086	0.125
BRT-105254.0	ER25 Collet-40	3.0	4.0	0.118	0.157
BRT-105254.8	ER25 Collet-48	3/16"		0.148	0.188
BRT-105255.0	ER25 Collet-50	4.0	5.0	0.157	0.197
BRT-105256.0	ER25 Collet-60	5.0	6.0	0.197	0.236
BRT-105256.4	ER25 Collet-64	1/4"		0.211	0.250
BRT-105257.0	ER25 Collet-70	6.0	7.0	0.236	0.276
BRT-105258.0	ER25 Collet-80	7.0	8.0	0.276	0.315
BRT-105259.0	ER25 Collet-90	8.0	9.0	0.315	0.354
BRT-105259.5	ER25 Collet-95	3/8"		0.336	0.375
BRT-1052510	ER25 Collet-100	9.0	10.0	0.354	0.394
BRT-1052511	ER25 Collet-110	10.0	11.0	0.394	0.433
BRT-1052512	ER25 Collet-120	11.0	12.0	0.433	0.472
BRT-10525127	ER25 Collet-127	1/2"		0.461	0.500
BRT-1052513	ER25 Collet-130	12.0	13.0	0.472	0.512
BRT-1052514	ER25 Collet-140	13.0	14.0	0.512	0.551
BRT-1052515	ER25 Collet-150	14.0	15.0	0.551	0.591
BRT-1052515.9	ER25 Collet-159	5/8"		0.586	0.625
BRT-1052516	ER25 Collet-160	15.0	16.0	0.591	0.630



\$31.51

Steel Sealed ER25 Collets

Part No.	Description	Holding Capacity			
		Metric		Inch	
BRT-SS5253.0	ER25SS Collet-30	2.0	3.0	0.079	0.118
BRT-SS5253.2	ER25SS Collet-32	1/8"		0.086	0.125
BRT-SS5254.0	ER25SS Collet-40	3.0	4.0	0.118	0.157
BRT-SS5254.8	ER25SS Collet-48	3/16"		0.148	0.188
BRT-SS5255.0	ER25SS Collet-50	4.0	5.0	0.157	0.197
BRT-SS5256.0	ER25SS Collet-60	5.0	6.0	0.197	0.236
BRT-SS5256.4	ER25SS Collet-64	1/4"		0.211	0.250
BRT-SS5257.0	ER25SS Collet-70	6.0	7.0	0.236	0.276
BRT-SS5258.0	ER25SS Collet-80	7.0	8.0	0.276	0.315
BRT-SS5259.0	ER25SS Collet-90	8.0	9.0	0.315	0.354
BRT-SS5259.5	ER25SS Collet-95	3/8"		0.336	0.375
BRT-SS52510	ER25SS Collet-100	9.0	10.0	0.354	0.394
BRT-SS52511	ER25SS Collet-110	10.0	11.0	0.394	0.433
BRT-SS52512	ER25SS Collet-120	11.0	12.0	0.433	0.472
BRT-SS525127	ER25SS Collet-127	1/2"		0.461	0.500
BRT-SS52513	ER25SS Collet-130	12.0	13.0	0.472	0.512
BRT-SS52514	ER25SS Collet-140	13.0	14.0	0.512	0.551
BRT-SS52515	ER25SS Collet-150	14.0	15.0	0.551	0.591
BRT-SS52515.9	ER25SS Collet-159	5/8"		0.586	0.625
BRT-SS52516	ER25SS Collet-160	15.0	16.0	0.591	0.630

SETS

ULTRA PRECISION ER COLLET SETS: DIN6499B

Ultra Precision ER25 Collets - SET - Inch

Part No.	Description
BRT-10525151	ER25 Collet Set 15 pc. (1/16"-5/8")

All Sets in an Plastic Case. (not exactly as pictured)

\$132.88

Ultra Precision ER25 Collets - SET - Metric

Part No.	Description
BRT-1052515	ER25 Collet Set 15 pc. (2-16)

All Sets in an Aluminum Case. (not exactly as pictured)

\$124.52

STEEL SEALED ER25 COLLET SET: DIN6499

Part No.	Description
BRT-SS52514S	ER25SS Steel Sealed Collet Set (3-16) 14 pc.

All Sets in an Aluminum Case. (not exactly as pictured)

\$458.80

ER25 Tap Collets (ANSI)

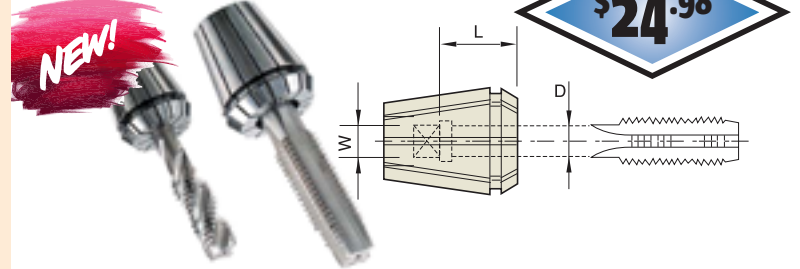

\$24.98

TAP	Part No.	Inch	Metric	D(φ)	W(□)	L
	BRT-TC525411	#6	M3	0.141	0.110	0.709
	BRT-TC525613	#8	M4	0.168	0.131	0.709
	BRT-TC525915	#10	M4.5+M5	0.194	0.152	0.709
	BRT-TC525216	#12	-	0.220	0.165	0.709
	BRT-TC525519	1/4	M6	0.255	0.191	0.709
	BRT-TC525123	5/16	M7+M8	0.318	0.238	0.866
	BRT-TC525622	3/8	M10	0.367	0.275	0.866
	BRT-TC525224	7/16	-	0.323	0.242	0.866
	BRT-TC525828	1/2	M12	0.381	0.286	0.866
	BRT-TC525232	9/16	M14	0.429	0.322	0.984
	BRT-TC525836	5/8	M16	0.480	0.360	0.984
	BRT-TC525440	11/16	M18	0.542	0.406	0.984
	BRT-TC525944	3/4	-	0.590	0.442	0.984
PIPE TAP	BRT-TCP25123	1/8"SS	-	0.312	0.234	0.787
	BRT-TCP25332	1/8"LS	-	0.437	0.328	0.787
	BRT-TCP25642	1/4"	-	0.562	0.420	0.787



\$12.92

Ultra Precision Standard ER32 Collets

Part No.	Description	Holding Capacity			
		Metric	Inch		
BRT-105322.0	ER32 Collet-20	1.5	2.0	0.059	0.079
BRT-105322.4	ER32 Collet-24	3/32"		0.075	0.094
BRT-105323.0	ER32 Collet-30	2.0	3.0	0.079	0.118
BRT-105323.2	ER32 Collet-32	1/8"		0.086	0.125
BRT-105324.0	ER32 Collet-40	3.0	4.0	0.118	0.157
BRT-105324.8	ER32 Collet-48	3/16"		0.148	0.188
BRT-105325.0	ER32 Collet-50	4.0	5.0	0.157	0.197
BRT-105326.0	ER32 Collet-60	5.0	6.0	0.197	0.236
BRT-105326.4	ER32 Collet-64	1/4"		0.211	0.250
BRT-105327.0	ER32 Collet-70	6.0	7.0	0.236	0.276
BRT-105328.0	ER32 Collet-80	7.0	8.0	0.276	0.315
BRT-105329.0	ER32 Collet-90	8.0	9.0	0.315	0.354
BRT-105329.5	ER32 Collet-95	3/8"		0.336	0.375
BRT-1053210.	ER32 Collet-100	9.0	10.0	0.354	0.394
BRT-1053211.	ER32 Collet-110	10.0	11.0	0.394	0.433
BRT-1053212.	ER32 Collet-120	11.0	12.0	0.433	0.472
BRT-10532127	ER32 Collet-127	1/2"		0.461	0.500
BRT-1053213.	ER32 Collet-130	12.0	13.0	0.472	0.512
BRT-1053214.	ER32 Collet-140	13.0	14.0	0.512	0.551
BRT-1053215.	ER32 Collet-150	14.0	15.0	0.551	0.591
BRT-10532159	ER32 Collet-159	5/8"		0.586	0.625
BRT-1053216.	ER32 Collet-160	15.0	16.0	0.591	0.630
BRT-1053217.	ER32 Collet-170	16.0	17.0	0.630	0.669
BRT-1053218.	ER32 Collet-180	17.0	18.0	0.669	0.709
BRT-1053219.	ER32 Collet-190	18.0	19.0	0.709	0.748
BRT-10532191	ER32 Collet-191	3/4"		0.713	0.750
BRT-1053220.	ER32 Collet-200	19.0	20.0	0.748	0.787



\$32.60

Steel Sealed ER32 Collets

Part No.	Description	Holding Capacity			
		Metric	Inch		
BRT-SS5323.0	ER32SS Collet-30	2.0	3.0	0.079	0.118
BRT-SS5323.2	ER32SS Collet-32	1/8"		0.086	0.125
BRT-SS5324.0	ER32SS Collet-40	3.0	4.0	0.118	0.157
BRT-SS5324.8	ER32SS Collet-48	3/16"		0.148	0.188
BRT-SS5325.0	ER32SS Collet-50	4.0	5.0	0.157	0.197
BRT-SS5326.0	ER32SS Collet-60	5.0	6.0	0.197	0.236
BRT-SS5326.4	ER32SS Collet-64	1/4"		0.211	0.250
BRT-SS5327.0	ER32SS Collet-70	6.0	7.0	0.236	0.276
BRT-SS5328.0	ER32SS Collet-80	7.0	8.0	0.276	0.315
BRT-SS5329.0	ER32SS Collet-90	8.0	9.0	0.315	0.354
BRT-SS5329.5	ER32SS Collet-95	3/8"		0.336	0.375
BRT-SS53210.	ER32SS Collet-100	9.0	10.0	0.354	0.394
BRT-SS53211.	ER32SS Collet-110	10.0	11.0	0.394	0.433
BRT-SS53212.	ER32SS Collet-120	11.0	12.0	0.433	0.472
BRT-SS532127	ER32SS Collet-127	1/2"		0.461	0.500
BRT-SS53213.	ER32SS Collet-130	12.0	13.0	0.472	0.512
BRT-SS53214.	ER32SS Collet-140	13.0	14.0	0.512	0.551
BRT-SS53215.	ER32SS Collet-150	14.0	15.0	0.551	0.591
BRT-SS532159	ER32SS Collet-159	5/8"		0.586	0.625
BRT-SS53216.	ER32SS Collet-160	15.0	16.0	0.591	0.630
BRT-SS53217.	ER32SS Collet-170	16.0	17.0	0.630	0.669
BRT-SS53218.	ER32SS Collet-180	17.0	18.0	0.669	0.709
BRT-SS53219.	ER32SS Collet-190	18.0	19.0	0.709	0.748
BRT-SS532191	ER32SS Collet-191	3/4"		0.713	0.750
BRT-SS53220.	ER32SS Collet-200	19.0	20.0	0.748	0.787

SETS

ULTRA PRECISION ER COLLET SETS: DIN6499B

Ultra Precision ER32 Collets - SET - Inch

Part No.	Description
BRT-10532181	ER32 Collet Set 18 pc. (1/8"-3/4")

All Sets in an Plastic Case. (not exactly as pictured)

\$191.38

Ultra Precision ER32 Collets - SET - Metric

Part No.	Description
BRT-1053218	ER32 Collet Set 18 pc. (3-20)

All Sets in an Aluminum Case. (not exactly as pictured)

\$178.85

STEEL SEALED ER32 COLLET SET: DIN6499

Part No.	Description
BRT-SS53218S	ER32SS Steel Sealed Collet Set (3-20) 18 pc.

All Sets in an Aluminum Case. (not exactly as pictured)

\$575.80

ER32 Tap Collets (ANSI)

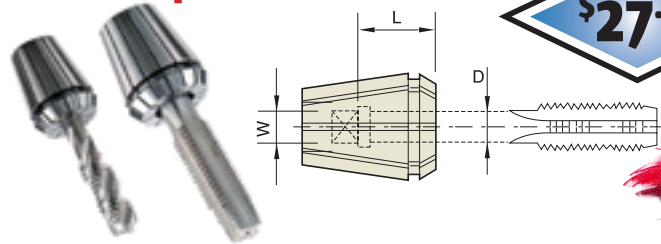

\$27.48

TAP	Part No.	Inch	Metric	D(φ)	W(□)	L
	BRT-TC532411	#6	M3	0.141	0.110	0.709
	BRT-TC532613	#8	M4	0.168	0.131	0.709
	BRT-TC532915	#10	M4.5+M5	0.194	0.152	0.709
	BRT-TC532216	#12	-	0.220	0.165	0.709
	BRT-TC532519	1/4	M6	0.255	0.191	0.709
	BRT-TC532123	5/16	M7+M8	0.318	0.238	0.866
	BRT-TC532627	3/8	M10	0.367	0.275	0.866
	BRT-TC532224	7/16	-	0.323	0.242	0.866
	BRT-TC532828	1/2	M12	0.381	0.286	0.866
	BRT-TC532232	9/16	M14	0.429	0.322	0.984
	BRT-TC532836	5/8	M16	0.480	0.360	0.984
	BRT-TC532440	11/16	M18	0.542	0.406	0.984
	BRT-TC532944	3/4	-	0.590	0.442	0.984
	BRT-TC532548	13/16	M20	0.652	0.489	0.984
PIPE TAP	BRT-TCP32123	1/8"SS	-	0.312	0.234	0.787
	BRT-TCP32332	1/8"LS	-	0.437	0.328	0.787
	BRT-TCP32642	1/4"	-	0.562	0.420	0.787



ER40 COLLETS

PRECISION TOOLS



\$17.80

Ultra Precision Standard ER40 Collets

Holding Capacity

Part No.	Description	Metric		Inch	
		Metric	Inch	Metric	Inch
BRT-105403.0	ER40 Collet-30	2.0	3.0	0.079	0.118
BRT-105403.2	ER40 Collet-32	1/8"		0.087	0.125
BRT-105404.0	ER40 Collet-40	3.0	4.0	0.118	0.157
BRT-105404.8	ER40 Collet-48	3/16"		0.150	0.188
BRT-105405.0	ER40 Collet-50	4.0	5.0	0.157	0.197
BRT-105406.0	ER40 Collet-60	5.0	6.0	0.197	0.236
BRT-105406.4	ER40 Collet-64	1/4"		0.213	0.250
BRT-105407.0	ER40 Collet-70	6.0	7.0	0.236	0.276
BRT-105408.0	ER40 Collet-80	7.0	8.0	0.276	0.315
BRT-105409.0	ER40 Collet-90	8.0	9.0	0.315	0.354
BRT-105409.5	ER40 Collet-95	3/8"		0.335	0.375
BRT-1054010.0	ER40 Collet-100	9.0	10.0	0.354	0.394
BRT-1054011.0	ER40 Collet-110	10.0	11.0	0.394	0.433
BRT-1054012.0	ER40 Collet-120	11.0	12.0	0.433	0.472
BRT-10540127	ER40 Collet-127	1/2"		0.461	0.500
BRT-1054013.0	ER40 Collet-130	12.0	13.0	0.472	0.512
BRT-1054014.0	ER40 Collet-140	13.0	14.0	0.512	0.551
BRT-1054015.0	ER40 Collet-150	14.0	15.0	0.551	0.591
BRT-10540159	ER40 Collet-159	5/8"		0.587	0.625
BRT-1054016.0	ER40 Collet-160	15.0	16.0	0.591	0.630
BRT-1054017.0	ER40 Collet-170	16.0	17.0	0.630	0.669
BRT-1054018.0	ER40 Collet-180	17.0	18.0	0.669	0.709
BRT-1054019.0	ER40 Collet-190	18.0	19.0	0.709	0.748
BRT-10540191	ER40 Collet-191	3/4"		0.713	0.750
BRT-1054020.0	ER40 Collet-200	19.0	20.0	0.748	0.787
BRT-1054021.0	ER40 Collet-210	20.0	21.0	0.787	0.827
BRT-1054022.0	ER40 Collet-220	21.0	22.0	0.827	0.866
BRT-10540222	ER40 Collet-222	7/8"		0.835	0.875
BRT-1054023.0	ER40 Collet-230	22.0	23.0	0.866	0.906
BRT-1054024.0	ER40 Collet-240	23.0	24.0	0.906	0.945
BRT-1054025.0	ER40 Collet-250	24.0	25.0	0.945	0.984
BRT-10540254	ER40 Collet-254	1"		0.961	1.000
BRT-1054026.0	ER40 Collet-260	25.0	26.0	0.984	1.024



\$37.44

Steel Sealed ER40 Collets

Holding Capacity

Part No.	Description	Metric		Inch	
		Metric	Inch	Metric	Inch
BRT-SS5403.0	ER40SS Collet-30	2.0	3.0	0.079	0.118
BRT-SS5403.2	ER40SS Collet-32	1/8"		0.087	0.125
BRT-SS5404.0	ER40SS Collet-40	3.0	4.0	0.118	0.157
BRT-SS5404.8	ER40SS Collet-48	3/16"		0.150	0.188
BRT-SS5405.0	ER40SS Collet-50	4.0	5.0	0.157	0.197
BRT-SS5406.0	ER40SS Collet-60	5.0	6.0	0.197	0.236
BRT-SS5406.4	ER40SS Collet-64	1/4"		0.213	0.250
BRT-SS5407.0	ER40SS Collet-70	6.0	7.0	0.236	0.276
BRT-SS5408.0	ER40SS Collet-80	7.0	8.0	0.276	0.315
BRT-SS5409.0	ER40SS Collet-90	8.0	9.0	0.315	0.354
BRT-SS5409.5	ER40SS Collet-95	3/8"		0.335	0.375
BRT-SS54010.0	ER40SS Collet-100	9.0	10.0	0.354	0.394
BRT-SS54011.0	ER40SS Collet-110	10.0	11.0	0.394	0.433
BRT-SS54012.0	ER40SS Collet-120	11.0	12.0	0.433	0.472
BRT-SS540127	ER40SS Collet-127	1/2"		0.461	0.500
BRT-SS54013.0	ER40SS Collet-130	12.0	13.0	0.472	0.512
BRT-SS54014.0	ER40SS Collet-140	13.0	14.0	0.512	0.551
BRT-SS54015.0	ER40SS Collet-150	14.0	15.0	0.551	0.591
BRT-SS540159	ER40SS Collet-159	5/8"		0.587	0.625
BRT-SS54016.0	ER40SS Collet-160	15.0	16.0	0.591	0.630
BRT-SS54017.0	ER40SS Collet-170	16.0	17.0	0.630	0.669
BRT-SS54018.0	ER40SS Collet-180	17.0	18.0	0.669	0.709
BRT-SS54019.0	ER40SS Collet-190	18.0	19.0	0.709	0.748
BRT-SS540191	ER40SS Collet-191	3/4"		0.713	0.750
BRT-SS54020.0	ER40SS Collet-200	19.0	20.0	0.748	0.787
BRT-SS54021.0	ER40SS Collet-210	20.0	21.0	0.787	0.827
BRT-SS54022.0	ER40SS Collet-220	21.0	22.0	0.827	0.866
BRT-SS540222	ER40SS Collet-222	7/8"		0.835	0.875
BRT-SS54023.0	ER40SS Collet-230	22.0	23.0	0.866	0.906
BRT-SS54024.0	ER40SS Collet-240	23.0	24.0	0.906	0.945
BRT-SS54025.0	ER40SS Collet-250	24.0	25.0	0.945	0.984
BRT-SS540254	ER40SS Collet-254	1"		0.961	1.000
BRT-SS54026.0	ER40SS Collet-260	25.0	26.0	0.984	1.024

SETS



ULTRA PRECISION ER COLLET SETS: DIN6499B

Ultra Precision ER40 Collets - SET - Inch

Part No.	Description
BRT-1054024I	ER40 Collet Set 24 pc. (1/8"-1")

All Sets in an Plastic Case. (not exactly as pictured)

\$249.88

Ultra Precision ER40 Collets - SET - Metric

Part No.	Description
BRT-1054023	ER40 Collet Set 23 pc. (4-26)

All Sets in an Aluminum Case. (not exactly as pictured)

\$241.52

STEEL SEALED ER40 COLLET SET: DIN6499

Part No.	Description
BRT-SS54023S	ER40SS Steel Sealed Collet Set (4-26) 23 pc.

All Sets in an Aluminum Case. (not exactly as pictured)

\$925.13

ER40 Tap Collets (ANSI)

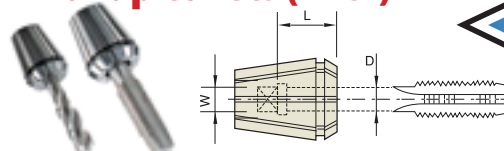

\$35.01

NEW!

TAP	Part No.	Inch	Metric	D(φ)	W(□)	L
	BRT-TC540411	#6	M3	0.141	0.110	0.709
	BRT-TC540613	#8	M4	0.168	0.131	0.709
	BRT-TC540915	#10	M4.5+M5	0.194	0.152	0.709
	BRT-TC540216	#12	-	0.220	0.165	0.709
	BRT-TC540519	1/4	M6	0.255	0.191	0.709
	BRT-TC540123	5/16	M7+M8	0.318	0.238	0.866
	BRT-TC540627	3/8	M10	0.367	0.275	0.866
	BRT-TC540224	7/16	-	0.323	0.242	0.866
	BRT-TC540828	1/2	M12	0.381	0.286	0.866
	BRT-TC540232	9/16	M14	0.429	0.322	0.984
	BRT-TC540836	5/8	M16	0.480	0.360	0.984
	BRT-TC540440	11/16	M18	0.542	0.406	0.984
	BRT-TC540944	3/4	-	0.590	0.442	0.984
	BRT-TC540548	13/16	M20	0.652	0.489	0.984
	BRT-TC540952	7/8	M22	0.697	0.523	0.984
	BRT-TC540657	15/16	M24	0.760	0.570	0.984
	BRT-TC540060	1	M25	0.800	0.600	1.102
PIPE TAP	BRT-TCP40123	1/8"SS	-	0.312	0.234	0.787
	BRT-TCP40332	1/8"LS	-	0.437	0.328	0.787
	BRT-TCP40642	1/4"	-	0.562	0.420	0.787
	BRT-TCP40053	3/8"	-	0.700	0.530	0.866
	BRT-TCP40851	1/2"	-	0.687	0.515	0.866
	BRT-TCP40067	3/4"	-	0.906	0.679	0.945



TG100 Collets

PRECISION TOOLS

- Precision Ground
- All hardened parts
- Clamping Range: 1/64"

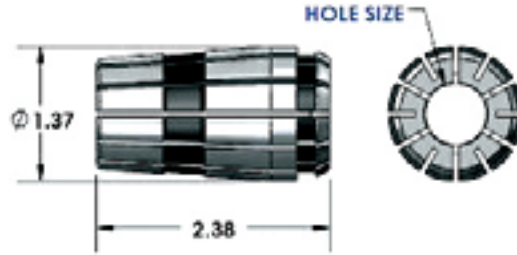

\$24.02



Part No.	Shank (Hole)
BRT-TG549902	1/32"
BRT-TG549903	3/64"
BRT-TG549904	1/16"
BRT-TG549905	5/64"
BRT-TG549906	3/32"
BRT-TG549907	7/64"
BRT-TG549908	1/8"
BRT-TG549909	9/64"
BRT-TG549910	5/32"
BRT-TG549911	11/64"
BRT-TG549912	3/16"
BRT-TG549913	13/64"
BRT-TG549914	7/32"
BRT-TG549915	15/64"
BRT-TG549916	1/4"
BRT-TG549917	17/64"
BRT-TG549918	9/32"
BRT-TG549919	19/64"
BRT-TG549920	5/16"
BRT-TG549921	21/64"
BRT-TG549922	11/32"
BRT-TG549923	23/64"
BRT-TG549924	3/8"
BRT-TG549925	25/64"
BRT-TG549926	13/32"
BRT-TG549927	27/64"
BRT-TG549928	7/16"
BRT-TG549929	29/64"
BRT-TG549930	15/32"
BRT-TG549931	31/64"
BRT-TG549932	1/2"
BRT-TG549933	33/64"

Part No.	Shank (Hole)
BRT-TG549934	17/32"
BRT-TG549935	35/64"
BRT-TG549936	9/16"
BRT-TG549937	37/64"
BRT-TG549938	19/32"
BRT-TG549939	39/64"
BRT-TG549940	5/8"
BRT-TG549941	41/64"
BRT-TG549942	21/32"
BRT-TG549943	43/64"
BRT-TG549944	11/16"
BRT-TG549945	45/64"
BRT-TG549946	23/32"
BRT-TG549947	47/64"
BRT-TG549948	3/4"
BRT-TG549949	49/64"
BRT-TG549950	25/32"
BRT-TG549951	51/64"
BRT-TG549952	13/16"
BRT-TG549953	53/64"
BRT-TG549954	27/32"
BRT-TG549955	55/64"
BRT-TG549956	7/8"
BRT-TG549957	57/64"
BRT-TG549958	29/32"
BRT-TG549959	59/64"
BRT-TG549960	15/16"
BRT-TG549961	61/64"
BRT-TG549962	31/32"
BRT-TG549963	63/64"
BRT-TG549964	1"

For TG100 Wrench see page 9

TG100 Collet - SET



Part No. BRT-TG1015SE
Description 15 pc. (1/8" - 1 x 1/16")
 (Case Included)

\$375.09



IP54 Metal case DIGITAL CALIPER

PRECISION TOOLS

- IP54 protection
- 3M/S high response speed
- DIN862 Standard hardened stainless steel structure
- 1.5V battery, low power consumption

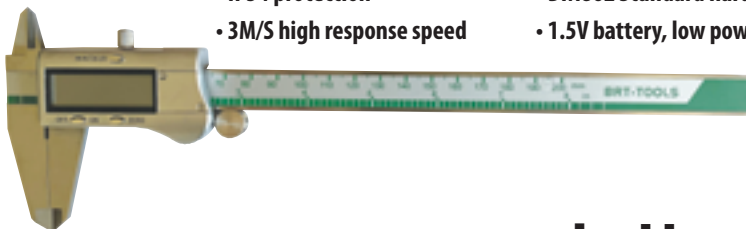

BRT-MI32731
 • 0-200mm / 0-8"
 • 0.01mm / 0.0005" Reg
 • +/- 0.03mm / +/- 0.0015"

\$58.42



CARBIDE BURRS

Speedway[®]

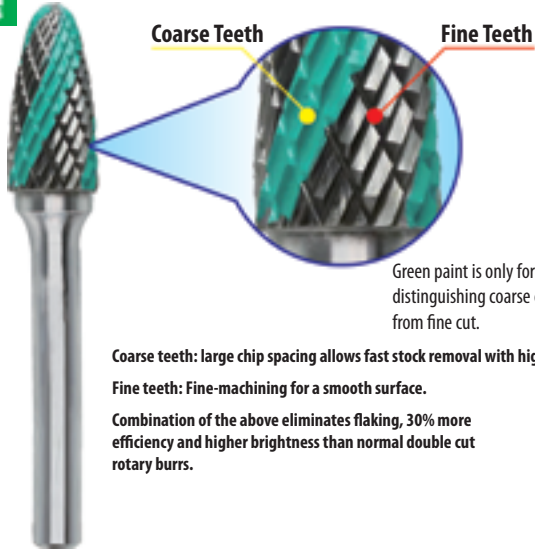

Coarse Teeth

Fine Teeth

Green paint is only for distinguishing coarse cut from fine cut.

Coarse teeth: large chip spacing allows fast stock removal with high efficiency.

Fine teeth: Fine-machining for a smooth surface.

Combination of the above eliminates flaking, 30% more efficiency and higher brightness than normal double cut rotary burrs.

SPEEDWAY CUT SETS



TEC-A01XM1T2

5 Pc. Set: Contains SA-3, SC-3, SD-3, SE-3, SG-3

\$55.13

TEC-27AR00042

5 Pc. Set: Contains SA-5, SC-5, SD-5, SE-5, SG-5

74.35

TEC-27AR00041

8 Pc. Set: Contains SA-1, SB-1, SC-1, SD-1, SE-1, SF-1, SG-1, SL-1

74.35

Cylindrical - Flat End, Non End Cut



double cut shown

Shank Diameter	Head Diameter	Cut Length	Trade No.	Single Cut	Price	Double Cut	Price	Speedway Cut	Price
3/32"	1/16"	1/4"	SA-61	BRT-12101	\$4.97	BRT-12102	\$4.97	-	-
3/32"	3/32"	3/8"	SA-63	BRT-12103	4.97	BRT-12104	4.97	-	-
1/8"	1/16"	1/4"	SA-41	BRT-12105	5.23	BRT-12106	5.23	-	-
1/8"	3/32"	7/16"	SA-42	BRT-12107	5.23	BRT-12108	5.23	-	-
1/8"	1/8"	9/16"	SA-43	BRT-12109	5.23	BRT-12110	5.23	-	-
1/8"	5/32"	1/2"	SA-52	BRT-12111	8.37	BRT-12112	8.37	-	-
1/8"	3/16"	1/2"	SA-53	BRT-12113	8.37	BRT-12114	8.37	-	-
1/8"	1/4"	1/2"	SA-51	BRT-12115	8.37	BRT-12116	8.37	-	-
3/16"	3/16"	1/2"	SA-81	BRT-12117	6.53	BRT-12118	6.53	-	-
1/4"	1/8"	1/2"	SA-11	BRT-12119	9.41	BRT-12120	9.41	-	-
1/4"	1/8"	5/8"	SA-12	BRT-12121	7.51	BRT-12122	7.51	-	-
1/4"	5/32"	5/8"	SA-13	BRT-12123	7.51	BRT-12124	7.51	-	-
1/4"	3/16"	5/8"	SA-14	BRT-12125	7.51	BRT-12126	7.51	-	-
1/4"	1/4"	5/8"	SA-1	BRT-12127	7.36	BRT-12128	7.36	BRT-12128SW	\$9.07
1/4"	1/4"	1"	SA-1L	BRT-12129	9.98	BRT-12130	9.98	-	-
1/4"	5/16"	3/4"	SA-2	BRT-12131	7.36	BRT-12132	7.36	-	-
1/4"	3/8"	3/4"	SA-3	BRT-12133	9.55	BRT-12134	9.55	BRT-12134SW	10.82
1/4"	3/8"	1"	SA-3L	BRT-12135	11.78	BRT-12136	11.78	-	-
1/4"	7/16"	1"	SA-4	BRT-12139	11.76	BRT-12140	11.76	-	-
1/4"	1/2"	1"	SA-5	BRT-12141	15.51	BRT-12142	15.51	BRT-12142SW	16.09
1/4"	5/8"	1"	SA-6	BRT-12143	20.46	BRT-12144	20.46	-	-
1/4"	3/4"	1/2"	SA-15	BRT-12145	26.91	BRT-12146	26.91	-	-
1/4"	3/4"	3/4"	SA-16	BRT-12147	33.26	BRT-12148	33.26	-	-
1/4"	3/4"	1"	SA-7	BRT-12149	26.68	BRT-12150	26.68	-	-
1/4"	1"	1"	SA-9	BRT-12151	39.01	BRT-12152	39.01	-	-

Cylindrical - Flat End, End Cut



double cut shown

Shank Diameter	Head Diameter	Cut Length	Trade No.	Single Cut	Price	Double Cut	Price	Speedway Cut	Price
1/8"	1/16"	1/4"	SB-41	BRT-12201	\$5.23	BRT-12202	\$5.23	-	-
1/8"	3/32"	7/16"	SB-42	BRT-12203	5.23	BRT-12204	5.23	-	-
1/8"	1/8"	9/16"	SB-43	BRT-12205	5.23	BRT-12206	5.23	-	-
1/8"	1/4"	3/16"	SB-51	BRT-12207	7.36	BRT-12208	7.36	-	-
1/4"	1/8"	1/2"	SB-11	BRT-12209	7.62	BRT-12210	7.62	-	-
1/4"	1/8"	5/8"	SB-12	BRT-12211	7.62	BRT-12212	7.62	-	-
1/4"	5/32"	5/8"	SB-13	BRT-12213	9.61	BRT-12214	9.61	-	-
1/4"	3/16"	5/8"	SB-14	BRT-12215	7.62	BRT-12216	7.62	-	-
1/4"	1/4"	5/8"	SB-1	BRT-12217	7.50	BRT-12218	7.50	BRT-12218SW	\$9.07
1/4"	1/4"	1"	SB-1L	BRT-12219	10.78	BRT-12220	10.78	-	-
1/4"	5/16"	3/4"	SB-2	BRT-12221	8.01	BRT-12222	8.01	-	-
1/4"	3/8"	3/4"	SB-3	BRT-12223	10.20	BRT-12224	10.20	BRT-12224SW	11.00
1/4"	7/16"	1"	SB-4	BRT-12225	12.41	BRT-12226	12.41	-	-
1/4"	1/2"	1"	SB-5	BRT-12227	15.63	BRT-12228	15.63	BRT-12228SW	16.51
1/4"	5/8"	1"	SB-6	BRT-12229	21.52	BRT-12230	21.52	-	-
1/4"	3/4"	1"	SB-7	BRT-12231	28.29	BRT-12232	28.29	-	-
1/4"	3/4"	1/2"	SB-15	BRT-12233	31.59	BRT-12234	31.59	-	-
1/4"	3/4"	3/4"	SB-16	BRT-12235	31.59	BRT-12236	31.59	-	-
1/4"	1"	1"	SB-9	BRT-12237	49.50	BRT-12238	49.50	-	-



CARBIDE BURRS

Cylindrical - Radius End



double cut shown

Shank Diameter	Head Diameter	Cut Length	Trade No.	Single Cut	Price	Double Cut	Price	Speedway Cut	Price
3/32"	3/32"	3/8"	SC-61	BRT-12301	\$4.97	BRT-12302	\$4.97	-	-
1/8"	3/32"	7/16"	SC-41	BRT-12303	5.23	BRT-12304	5.23	-	-
1/8"	1/8"	9/16"	SC-42	BRT-12305	5.23	BRT-12306	5.23	-	-
1/8"	5/32"	1/2"	SC-52	BRT-12307	8.37	BRT-12308	8.37	-	-
1/8"	3/16"	1/2"	SC-53	BRT-12309	8.37	BRT-12310	8.37	-	-
1/8"	1/4"	1/2"	SC-51	BRT-12311	8.37	BRT-12312	8.37	-	-
3/16"	3/16"	1/2"	SC-81	BRT-12313	6.53	BRT-12314	7.51	-	-
1/4"	1/8"	1/2"	SC-11	BRT-12315	7.51	BRT-12316	7.51	-	-
1/4"	1/8"	5/8"	SC-12	BRT-12317	7.51	BRT-12318	7.51	-	-
1/4"	5/32"	5/8"	SC-13	BRT-12319	7.51	BRT-12320	7.51	-	-
1/4"	3/16"	5/8"	SC-14	BRT-12321	7.51	BRT-12322	7.51	-	-
1/4"	1/4"	5/8"	SC-1	BRT-12323	7.50	BRT-12324	7.50	BRT-12324SW	\$9.07
1/4"	1/4"	1"	SC-1L	BRT-12325	10.75	BRT-12326	10.75	-	-
1/4"	5/16"	3/4"	SC-2	BRT-12327	7.21	BRT-12328	7.21	-	-
1/4"	3/8"	3/4"	SC-3	BRT-12329	9.27	BRT-12330	9.27	BRT-12330SW	11.00
1/4"	3/8"	1"	SC-3L	BRT-12331	11.78	BRT-12332	11.78	-	-
1/4"	7/16"	1"	SC-4	BRT-12335	11.36	BRT-12336	11.36	BRT-12336SW	14.04
1/4"	1/2"	1"	SC-5	BRT-12337	13.83	BRT-12338	13.83	BRT-12338SW	15.26
1/4"	5/8"	1"	SC-6	BRT-12339	19.26	BRT-12340	19.26	-	-
1/4"	3/4"	1/2"	SC-15	BRT-12341	33.26	BRT-12342	33.26	-	-
1/4"	3/4"	3/4"	SC-16	BRT-12343	40.79	BRT-12344	40.79	-	-
1/4"	3/4"	1"	SC-7	BRT-12345	28.58	BRT-12346	28.58	-	-
1/4"	1"	1"	SC-9	BRT-12347	45.82	BRT-12348	45.82	-	-

Flame



double cut shown

Shank Diameter	Head Diameter	Cut Length	Trade No.	Single Cut	Price	Double Cut	Price	Speedway Cut	Price
1/8"	1/8"	1/4"	SH-41	BRT-12401	\$5.23	BRT-12402	\$5.23	-	-
1/8"	3/16"	3/8"	SH-531	BRT-12403	8.37	BRT-12404	8.37	-	-
1/4"	1/4"	5/8"	SH-1	BRT-12405	7.50	BRT-12406	7.50	BRT-12406SW	\$9.07
1/4"	5/16"	3/4"	SH-2	BRT-12407	6.72	BRT-12408	6.72	BRT-12408SW	7.79
1/4"	1/2"	1-1/4"	SH-5	BRT-12409	13.83	BRT-12410	13.83	BRT-12410SW	14.79
1/4"	5/8"	1-7/16"	SH-6	BRT-12411	28.70	BRT-12412	28.70	-	-
1/4"	3/4"	1-5/8"	SH-7	BRT-12413	32.42	BRT-12414	32.42	-	-

Ball



double cut shown

Shank Diameter	Head Diameter	Cut Length	Trade No.	Single Cut	Price	Double Cut	Price	Speedway Cut	Price
3/32"	3/32"	3/32"	SD-61	BRT-12501	\$4.97	BRT-12502	\$4.97	-	-
1/8"	3/32"	3/32"	SD-41	BRT-12503	5.23	BRT-12504	5.23	-	-
1/8"	1/8"	1/8"	SD-42	BRT-12505	5.23	BRT-12506	5.23	-	-
1/8"	5/32"	5/32"	SD-52	BRT-12507	8.37	BRT-12508	8.37	-	-
1/8"	3/16"	3/16"	SD-53	BRT-12509	8.37	BRT-12510	8.37	-	-
1/8"	1/4"	1/4"	SD-51	BRT-12511	8.37	BRT-12512	8.37	-	-
3/16"	3/16"	3/16"	SD-81	BRT-12513	6.53	BRT-12514	6.53	-	-
1/4"	1/8"	3/32"	SD-11	BRT-12515	7.36	BRT-12516	7.36	-	-
1/4"	3/16"	1/8"	SD-14	BRT-12517	7.51	BRT-12518	7.51	-	-
1/4"	1/4"	3/16"	SD-1	BRT-12519	7.06	BRT-12520	7.06	BRT-12520SW	\$9.07
1/4"	5/16"	1/4"	SD-2	BRT-12521	6.10	BRT-12522	6.10	-	-
1/4"	3/8"	5/16"	SD-3	BRT-12523	7.48	BRT-12524	7.48	BRT-12524SW	10.26
1/4"	7/16"	3/8"	SD-4	BRT-12525	8.15	BRT-12526	8.15	-	-
1/4"	1/2"	7/16"	SD-5	BRT-12527	10.17	BRT-12528	10.17	BRT-12528SW	15.26
1/4"	5/8"	9/16"	SD-6	BRT-12529	14.55	BRT-12530	14.55	-	-
1/4"	3/4"	11/16"	SD-7	BRT-12531	20.58	BRT-12532	20.58	-	-
1/4"	1"	15/16"	SD-9	BRT-12533	32.90	BRT-12534	32.90	-	-

Oval / Egg



double cut shown

Shank Diameter	Head Diameter	Cut Length	Trade No.	Single Cut	Price	Double Cut	Price	Speedway Cut	Price
3/32"	3/32"	1/8"	SE-61	BRT-12801	\$4.97	BRT-12802	\$4.97	-	-
1/8"	1/8"	7/32"	SE-41	BRT-12803	5.23	BRT-12804	5.23	-	-
1/8"	3/16"	9/32"	SE-53	BRT-12805	8.37	BRT-12806	8.37	-	-
1/8"	1/4"	3/8"	SE-51	BRT-12807	8.37	BRT-12808	8.37	-	-
1/4"	3/16"	5/16"	SE-11	BRT-12809	8.11	BRT-12810	8.11	-	-
1/4"	1/4"	3/8"	SE-1	BRT-12811	6.90	BRT-12812	6.90	BRT-12812SW	\$9.07
1/4"	3/8"	5/8"	SE-3	BRT-12813	8.49	BRT-12814	8.49	BRT-12814SW	10.40
1/4"	1/2"	7/8"	SE-5	BRT-12815	12.16	BRT-12816	12.16	BRT-12816SW	15.26
1/4"	5/8"	1"	SE-6	BRT-12817	17.85	BRT-12818	17.85	-	-
1/4"	3/4"	1"	SE-7	BRT-12819	23.86	BRT-12820	23.86	-	-



CARBIDE BURRS

Tree - Radius End



double cut shown

Shank Diameter	Head Diameter	Cut Length	Trade No.	Single Cut	Price	Double Cut	Price	Speedway Cut	Price
3/32"	3/32"	1/4"	SF-61	BRT-12601	\$4.97	BRT-12602	\$4.97	-	-
1/8"	1/8"	1/4"	SF-41	BRT-12603	5.23	BRT-12604	5.23	-	-
1/8"	1/8"	1/2"	SF-42	BRT-12605	5.23	BRT-12606	5.23	-	-
1/8"	3/16"	1/2"	SF-53	BRT-12607	8.37	BRT-12608	8.37	-	-
1/8"	1/4"	1/2"	SF-51	BRT-12609	8.37	BRT-12610	8.37	-	-
3/16"	3/16"	1/2"	SF-81	BRT-12611	6.53	BRT-12612	6.53	-	-
1/4"	1/8"	1/2"	SF-11	BRT-12613	7.65	BRT-12614	7.65	-	-
1/4"	1/4"	5/8"	SF-1	BRT-12615	8.34	BRT-12616	8.34	BRT-12616SW	\$9.07
1/4"	3/8"	3/4"	SF-3	BRT-12617	9.13	BRT-12618	9.13	BRT-12618SW	10.25
1/4"	7/16"	1"	SF-4	BRT-12619	10.53	BRT-12620	10.53	-	-
1/4"	1/2"	3/4"	SF-13	BRT-12621	12.92	BRT-12622	12.92	-	-
1/4"	1/2"	1"	SF-5	BRT-12623	12.50	BRT-12624	12.16	BRT-12624SW	15.26
1/4"	5/8"	1"	SF-6	BRT-12625	16.89	BRT-12626	16.89	-	-
1/4"	3/4"	1"	SF-7	BRT-12627	21.84	BRT-12628	21.84	-	-
1/4"	3/4"	1-1/4"	SF-8	BRT-12629	42.59	BRT-12630	42.59	-	-
1/4"	3/4"	1-1/2"	SF-15	BRT-12631	42.46	BRT-12632	42.46	-	-

Tree - Pointed End



double cut shown

Shank Diameter	Head Diameter	Cut Length	Trade No.	Single Cut	Price	Double Cut	Price	Speedway Cut	Price
3/32"	3/32"	1/4"	SG-61	BRT-12701	\$4.97	BRT-12702	\$4.97	-	-
1/8"	1/8"	1/4"	SG-41	BRT-12703	5.23	BRT-12704	5.23	-	-
1/8"	1/8"	1/2"	SG-44	BRT-12705	5.23	BRT-12706	5.23	-	-
1/8"	1/4"	1/2"	SG-51	BRT-12707	8.37	BRT-12708	8.37	-	-
1/8"	1/8"	5/16"	SG-42	BRT-12709	5.23	BRT-12710	5.23	-	-
1/8"	1/8"	3/8"	SG-43	BRT-12711	5.23	BRT-12712	5.23	-	-
1/8"	3/16"	1/2"	SG-53	BRT-12713	8.37	BRT-12714	8.37	-	-
3/16"	3/16"	1/2"	SG-81	BRT-12715	6.53	BRT-12716	6.53	-	-
1/4"	1/4"	5/8"	SG-1	BRT-12717	7.50	BRT-12718	7.50	BRT-12718SW	\$9.07
1/4"	5/16"	3/4"	SG-2	BRT-12719	6.60	BRT-12720	6.60	-	-
1/4"	3/8"	3/4"	SG-3	BRT-12721	8.31	BRT-12722	8.31	BRT-12722SW	10.07
1/4"	1/2"	3/4"	SG-13	BRT-12723	12.74	BRT-12724	12.74	-	-
1/4"	1/2"	1"	SG-5	BRT-12725	11.43	BRT-12726	11.43	BRT-12726SW	15.26
1/4"	5/8"	1"	SG-6	BRT-12727	15.87	BRT-12728	15.87	-	-
1/4"	3/4"	1"	SG-7	BRT-12729	21.00	BRT-12730	21.00	-	-
1/4"	3/4"	1-1/2"	SG-15	BRT-12731	42.46	BRT-12732	42.46	-	-

Cone



double cut shown

Shank Diameter	Head Diameter	Cut Length	Cut Angle	Trade No.	Single Cut	Price	Double Cut	Price
3/32"	3/32"	1/4"	10°	SM-61	BRT-12901	\$4.97	BRT-12902	\$4.97
1/8"	1/8"	11/32"	12°	SM-41	BRT-12903	5.23	BRT-12904	5.23
1/8"	1/8"	7/16"	14°	SM-42	BRT-12905	5.23	BRT-12906	5.23
1/8"	1/8"	5/8"	7°	SM-43	BRT-12907	5.23	BRT-12908	5.23
1/8"	3/16"	1/2"	16°	SM-53	BRT-12909	8.37	BRT-12910	8.37
1/8"	1/4"	1/2"	22°	SM-51	BRT-12911	8.37	BRT-12912	8.37
1/4"	1/4"	1/2"	22°	SM-1	BRT-12913	6.60	BRT-12914	6.60
1/4"	1/4"	3/4"	14°	SM-2	BRT-12915	7.21	BRT-12916	7.21
1/4"	1/4"	1"	10°	SM-3	BRT-12917	7.50	BRT-12918	7.50
1/4"	3/8"	5/8"	28°	SM-4	BRT-12919	8.04	BRT-12920	8.04
1/4"	1/2"	7/8"	28°	SM-5	BRT-12921	10.83	BRT-12922	10.83
1/4"	5/8"	1"	31°	SM-6	BRT-12923	13.62	BRT-12924	13.62

60° Cone



double cut shown

Shank Diameter	Head Diameter	Cut Length	Cut Angle	Trade No.	Single Cut	Price	Double Cut	Price
1/8"	1/8"	1/8"	60°	SJ-42	BRT-13001	\$5.23	BRT-13002	\$5.23
1/4"	1/4"	3/16"	60°	SJ-1	BRT-13003	6.90	BRT-13004	6.90
1/4"	3/8"	5/16"	60°	SJ-3	BRT-13005	7.89	BRT-13006	7.89
1/4"	1/2"	7/16"	60°	SJ-5	BRT-13007	9.72	BRT-13008	9.72
1/4"	5/8"	1/2"	60°	SJ-6	BRT-13009	14.04	BRT-13010	14.04
1/4"	3/4"	11/16"	60°	SJ-7	BRT-13011	19.02	BRT-13012	19.02
1/4"	1"	15/16"	60°	SJ-9	BRT-13013	25.08	BRT-13014	25.08



CARBIDE BURRS

90° CONE



double cut shown

Shank Diameter	Head Diameter	Cut Length	Cut Angle	Trade No.	Single Cut	Price	Double Cut	Price
1/8"	1/8"	1/16"	90°	SK-42	BRT-13101	\$4.17	BRT-13102	\$4.17
1/4"	1/4"	1/8"	90°	SK-1	BRT-13103	6.90	BRT-13104	6.90
1/4"	3/8"	3/16"	90°	SK-3	BRT-13105	7.65	BRT-13106	7.65
1/4"	1/2"	1/4"	90°	SK-5	BRT-13107	9.72	BRT-13108	9.72
1/4"	5/8"	5/16"	90°	SK-6	BRT-13109	13.79	BRT-13110	13.79
1/4"	3/4"	3/8"	90°	SK-7	BRT-13111	18.03	BRT-13112	18.03
1/4"	1"	1/2"	90°	SK-9	BRT-13113	23.96	BRT-13114	23.96

Inverted Cone



double cut shown

Shank Diameter	Head Diameter	Cut Length	Cut Angle	Trade No.	Single Cut	Price	Double Cut	Price
3/32"	3/32"	1/8"	/	SN-61	BRT-13201	\$4.97	BRT-13202	\$4.97
1/8"	3/32"	1/8"	/	SN-41	BRT-13203	5.23	BRT-13204	5.23
1/8"	1/8"	3/16"	/	SN-42	BRT-13205	5.23	BRT-13206	5.23
1/8"	3/16"	1/4"	/	SN-53	BRT-13207	8.37	BRT-13208	8.37
1/8"	1/4"	1/4"	/	SN-51	BRT-13209	8.37	BRT-13210	8.37
3/16"	3/16"	1/4"	/	SN-81	BRT-13211	6.53	BRT-13212	6.53
1/4"	1/4"	5/16"	/	SN-1	BRT-13213	7.21	BRT-13214	7.21
1/4"	3/8"	3/8"	/	SN-3	BRT-13215	11.19	BRT-13216	11.19
1/4"	1/2"	1/2"	28°	SN-4	BRT-13217	11.19	BRT-13218	11.19
1/4"	1/2"	1/2"	16°	SN-5	BRT-13219	14.17	BRT-13220	14.17
1/4"	5/8"	3/4"	/	SN-6	BRT-13221	14.61	BRT-13222	14.61
1/4"	3/4"	5/8"	/	SN-7	BRT-13223	17.91	BRT-13224	17.91

Taper - Radius End



double cut shown

Shank Diameter	Head Diameter	Cut Length	Cut Angle	Trade No.	Single Cut	Price	Double Cut	Price	Speedway Cut	Price
1/8"	1/8"	3/8"	8°	SL-41	BRT-13301	\$5.23	BRT-13302	\$5.23	-	-
1/8"	1/8"	1/2"	8°	SL-42	BRT-13303	5.23	BRT-13304	5.23	-	-
1/8"	3/16"	1/2"	14°	SL-53	BRT-13305	8.37	BRT-13306	8.37	-	-
3/16"	3/16"	7/16"	14°	SL-81	BRT-13307	6.53	BRT-13308	6.53	-	-
1/4"	1/4"	5/8"	14°	SL-1	BRT-13309	7.50	BRT-13310	7.50	-	-
1/4"	5/16"	7/8"	14°	SL-2	BRT-13311	7.50	BRT-13312	7.50	-	-
1/4"	3/8"	1-1/16"	14°	SL-3	BRT-13313	8.96	BRT-13314	8.96	BRT-13314SW	\$10.95
1/4"	1/2"	1-1/8"	14°	SL-4	BRT-13315	12.93	BRT-13316	12.93	BRT-13316SW	14.15
1/4"	5/8"	1-3/16"	14°	SL-5	BRT-13317	17.01	BRT-13318	17.01	-	-
1/4"	5/8"	1-5/16"	14°	SL-6	BRT-13319	22.24	BRT-13320	22.24	-	-
1/4"	3/4"	1-1/2"	14°	SL-7	BRT-13321	32.65	BRT-13322	32.65	-	-

Alumacut Carbide Burrs

Cylindrical - Flat End



Shank Diameter	Head Diameter	Cut Length	Trade No.	Clog Free	Price
1/4"	1/4"	5/8"	SA-1F	BRT-13501	\$12.51
1/4"	3/8"	3/4"	SA-3F	BRT-13502	16.23
1/4"	1/2"	1"	SA-5F	BRT-13503	24.78
1/4"	5/8"	1"	SA-6F	BRT-13504	33.26
1/4"	3/4"	1"	SA-7F	BRT-13505	43.13

Tree - Flat End



Shank Diameter	Head Diameter	Cut Length	Trade No.	Clog Free	Price
1/4"	1/4"	5/8"	SL-1F	BRT-13551	\$12.75
1/4"	3/8"	1-1/16"	SL-3F	BRT-13552	15.25
1/4"	1/2"	1-1/8"	SL-5F	BRT-13553	20.81
1/4"	5/8"	1-3/16"	SL-6F	BRT-13554	30.84
1/4"	3/4"	1-1/2"	SL-7F	BRT-13556	44.97

Cylindrical - Radius End



Shank Diameter	Head Diameter	Cut Length	Trade No.	Clog Free	Price
1/4"	1/4"	5/8"	SC-1F	BRT-13521	\$12.75
1/4"	3/8"	3/4"	SC-3F	BRT-13522	15.75
1/4"	1/2"	1"	SC-5F	BRT-13523	23.53
1/4"	5/8"	1"	SC-6F	BRT-13524	30.84
1/4"	3/4"	1"	SC-7F	BRT-13525	39.32

Ball



Shank Diameter	Head Diameter	Cut Length	Trade No.	Clog Free	Price
1/4"	1/4"	1/4"	SD-1F	BRT-13561	\$12.00
1/4"	3/8"	3/8"	SD-3F	BRT-13562	12.69
1/4"	1/2"	1/2"	SD-5F	BRT-13563	17.28
1/4"	5/8"	9/16"	SD-6F	BRT-13564	23.81
1/4"	3/4"	11/16"	SD-7F	BRT-13565	31.67

Tree - Radius End



Shank Diameter	Head Diameter	Cut Length	Trade No.	Clog Free	Price
1/4"	1/4"	5/8"	SF-1F	BRT-13531	\$7.50
1/4"	3/8"	3/4"	SF-3F	BRT-13532	14.38
1/4"	1/2"	1"	SF-5F	BRT-13533	20.67
1/4"	5/8"	1"	SF-6F	BRT-13534	26.69
1/4"	3/4"	1"	SF-7F	BRT-13535	24.23

Oval / Egg



Shank Diameter	Head Diameter	Cut Length	Trade No.	Clog Free	Price
1/4"	3/8"	5/8"	SE-3F	BRT-13571	\$14.44
1/4"	1/2"	7/8"	SE-5F	BRT-13572	20.67
1/4"	5/8"	1"	SE-6F	BRT-13573	26.27
1/4"	3/4"	1"	SE-7F	BRT-13574	36.22



CARBIDE BURRS

Extra-Long Carbide Burrs

Cylindrical - Flat End *double cut shown*

Shank Diameter	Head Diameter	Cut Length	Trade No.	Length	Double Cut	Price
1/8"	1/16"	1/4"	SA-41L3	3"	BRT-13602	\$9.30
1/8"	1/8"	9/16"	SA-43L3	3"	BRT-13604	9.30
1/4"	1/4"	1/2"	SA-1L6	6"	BRT-13606	12.10
1/4"	3/8"	3/4"	SA-3L6	6"	BRT-13608	17.46
1/4"	1/2"	1"	SA-5L6	6"	BRT-13610	22.72

Cylindrical - Flat End, End Cut *double cut shown*

Shank Diameter	Head Diameter	Cut Length	Trade No.	Length	Double Cut	Price
1/8"	1/18"	9/16"	SA-43L3	3"	BRT-13612	\$9.30

Cylindrical - Radius End *double cut shown*

Shank Diameter	Head Diameter	Cut Length	Trade No.	Length	Double Cut	Price
1/8"	1/8"	9/16"	SC-42L3	3"	BRT-13622	\$9.30
1/4"	1/4"	1/2"	SC-1L6	6"	BRT-13624	12.10
1/4"	3/8"	3/4"	SC-3L6	6"	BRT-13626	17.46
1/4"	1/2"	1"	SC-5L6	6"	BRT-13628	22.72

Tree Point *double cut shown*

Shank Diameter	Head Diameter	Cut Length	Trade No.	Length	Double Cut	Price
1/8"	1/8"	1/2"	SG-44L3	3"	BRT-13632	\$9.30
1/4"	1/4"	1/2"	SG-1L6	6"	BRT-13634	12.10
1/4"	3/8"	3/4"	SG-3L6	6"	BRT-13636	17.49
1/4"	1/2"	1"	SG-5L6	6"	BRT-13638	22.72

Tree - Radius End *double cut shown*

Shank Diameter	Head Diameter	Cut Length	Trade No.	Length	Double Cut	Price
1/8"	1/8"	1/2"	SF-42L3	3"	BRT-13642	\$9.30
1/4"	1/4"	1/2"	SF-1L6	6"	BRT-13644	12.10
1/4"	3/8"	3/4"	SF-3L6	6"	BRT-13646	17.46
1/4"	1/2"	1"	SF-5L6	6"	BRT-13648	22.71

Ball *double cut shown*

Shank Diameter	Head Diameter	Cut Length	Trade No.	Length	Double Cut	Price
1/8"	1/8"	1/8"	SD-42L3	3"	BRT-13652	\$9.30
1/4"	1/4"	7/32"	SD-1L6	6"	BRT-13654	12.10
1/4"	3/8"	5/16"	SD-3L6	6"	BRT-13656	12.10
1/4"	1/2"	7/16"	SD-5L6	6"	BRT-13658	17.46

Flame *double cut shown*

Shank Diameter	Head Diameter	Cut Length	Trade No.	Length	Double Cut	Price
1/8"	1/8"	1/4"	SH-41L3	3"	BRT-13662	\$79.30
1/4"	3/8"	3/4"	SH-2L6	6"	BRT-13664	17.46
1/4"	1/2"	1-1/4"	SH-5L6	6"	BRT-13666	22.72

Oval / Egg *double cut shown*

Shank Diameter	Head Diameter	Cut Length	Trade No.	Length	Double Cut	Price
1/4"	1/4"	3/8"	SE-1L6	6"	BRT-13674	\$12.10
1/4"	3/8"	5/8"	SE-3L6	6"	BRT-13676	17.46
1/4"	1/2"	7/8"	SE-5L6	6"	BRT-13678	22.72

Cone Point *double cut shown*

Shank Diameter	Head Diameter	Cut Length	Trade No.	Length	Double Cut	Price
1/8"	1/8"	7/16"	SM-42L3	6"	BRT-13682	\$9.30

14° Taper - Radius End *double cut shown*

Shank Diameter	Head Diameter	Cut Length	Trade No.	Length	Double Cut	Price
1/4"	1/4"	5/8"	SL-1L6	6"	BRT-13694	\$12.10
1/4"	3/8"	1-1/16"	SL-3L6	6"	BRT-13696	17.46
1/4"	1/2"	1-1/8"	SL-4L6	6"	BRT-13698	22.72



CARBIDE ENDMILLS

TOUGH ENDMILLS BUT FAIR PRICING!

2 Flute Regular Length

These are designed for slotting, drilling, pocketing and general purpose operations.

Suitable for cutting hardened & high alloy steels, steel casting, chill casting, malleable cast iron, CrNi-steels, brass, copper, aluminum with a high percentage of silicon and abrasive plastics.



Uncoated

Part No. Uncoated	Mill Diameter	Shank Diameter	Length of Cut	Overall Length	Price
BRT-E0101554	1/16	1/8	3/16	1-1/2	\$4.88
BRT-E0101558	1/8	1/8	1/2	1-1/2	4.88
BRT-E0101565	3/16	3/16	5/8	2	6.86
BRT-E0101573	1/4	1/4	3/4	2-1/2	7.63
BRT-E0101579	5/16	5/16	13/16	2-1/2	11.70
BRT-E0101584	3/8	3/8	1	2-1/2	13.54
BRT-E0101588	7/16	7/16	1	2-3/4	18.30
BRT-E0101593	1/2	1/2	1	3	20.81
BRT-E0101595	5/8	5/8	1-1/4	3-1/2	42.79
BRT-E0101598	3/4	3/4	1-1/2	4	53.66
BRT-E0101600	1	1	1-1/2	4	107.80



TiAlN Coated

Part No. Coated	Mill Diameter	Shank Diameter	Length of Cut	Overall Length	Price
BRT-E0201554	1/16	1/8	3/16	1-1/2	5.69
BRT-E0201558	1/8	1/8	1/2	1-1/2	5.69
BRT-E0201565	3/16	3/16	5/8	2	7.48
BRT-E0201573	1/4	1/4	3/4	2-1/2	8.11
BRT-E0201579	5/16	5/16	13/16	2-1/2	12.45
BRT-E0201584	3/8	3/8	7/8	2-1/2	15.80
BRT-E0201588	7/16	7/16	1	2-3/4	14.87
BRT-E0201593	1/2	1/2	1	3	22.48
BRT-E0201595	5/8	5/8	1 1/4	3-1/2	46.72
BRT-E0201598	3/4	3/4	1 1/2	4	58.42
BRT-E0201600	1	1	1 1/2	4	116.17

4 Flute Regular Length

Possible for high-speed cutting, suitable for high efficiency machining for hardened & high alloy steels, steel casting, chill casting, malleable cast iron, CrNi-steels, brass, copper, aluminum with a high percentage of silicon and abrasive plastics.



Uncoated

Part No. Uncoated	Mill Diameter	Shank Diameter	Length of Cut	Overall Length	Price
BRT-E0307554	1/16	1/8	3/16	1-1/2	\$4.88
BRT-E0307558	1/8	1/8	1/2	1-1/2	4.88
BRT-E0307565	3/16	3/16	5/8	2	6.86
BRT-E0307573	1/4	1/4	3/4	2-1/2	7.63
BRT-E0307579	5/16	5/16	13/16	2-1/2	11.70
BRT-E0307584	3/8	3/8	1	2-1/2	13.54
BRT-E0307588	7/16	7/16	1	2-3/4	18.30
BRT-E0307593	1/2	1/2	1	3	20.81
BRT-E0307595	5/8	5/8	1-1/4	3-1/2	42.79
BRT-E0307598	3/4	3/4	1-1/2	4	53.66
BRT-E0307600	1	1	1-1/2	4	107.80



TiAlN Coated

Part No. Coated	Mill Diameter	Shank Diameter	Length of Cut	Overall Length	Price
BRT-E0407554	1/16	1/8	3/16	1-1/2	\$5.69
BRT-E0407558	1/8	1/8	1/2	1-1/2	5.69
BRT-E0407565	3/16	3/16	5/8	2	7.48
BRT-E0407573	1/4	1/4	3/4	2-1/2	8.11
BRT-E0407579	5/16	5/16	13/16	2-1/2	12.45
BRT-E0407584	3/8	3/8	7/8	2-1/2	15.80
BRT-E0407588	7/16	7/16	1	2-3/4	14.87
BRT-E0407593	1/2	1/2	1	3	22.48
BRT-E0407595	5/8	5/8	1 1/4	3-1/2	46.72
BRT-E0407598	3/4	3/4	1 1/2	4	58.42
BRT-E0407600	1	1	1 1/2	4	116.17

Carbide 4 Flute Regular Length, Ball Nose

TiAlN Coated

• Suitable for cutting hardened & high alloy steels, steel castings, chill casting, malleable cast iron, CrNi-steels, brass, copper, aluminum with a percentage of silicon and abrasive plastics



Part Number	Diameter	Shank Diameter	L.O.C.	O.A.L.	Price
BRT-E0643558	1/8"	1/8"	1/2"	1-1/2"	\$6.52
BRT-E0643565	3/16"	3/16"	5/8"	2"	8.32
BRT-E0643573	1/4"	1/4"	3/4"	2-1/2"	13.46
BRT-E0643579	5/16"	5/16"	7/8"	2-1/2"	15.68
BRT-E0643584	3/8"	3/8"	1"	2-1/2"	23.93
BRT-E0643593	1/2"	1/2"	1"	3"	32.09
BRT-E0643595	5/8"	5/8"	1-1/4"	3-1/2"	41.71
BRT-E0643598	3/4"	3/4"	1-1/2"	4"	80.24
BRT-E0643600	1"	1"	1-1/2"	4"	150.45

Variable Helix Carbide End Mills

- A Variable Helix that reduces vibration and allows for smoother cutting performance
- Designed for: Mild Steels, Stainless Steel, Cast Irons, Tool Steels, Titanium Alloys, Pre-hardened Steels and Low Hardness materials under HRC 40.
- Excellent work piece finishes.
- Higher speeds, deeper cuts and higher feed rates.
- TiAlN coated



Part Number	Diameter	L.O.C.	O.A.L.	Price
BRT-E0712008	1/8"	1/2"	1-1/2"	\$10.24
BRT-E0712016	1/4"	3/4"	2-1/2"	17.09
BRT-E0737024	3/8"	7/8"	2-1/2"	27.79
BRT-E0737028	7/16"	1"	2-3/4"	39.20
BRT-E0737032	1/2"	1"	3"	42.41
BRT-E0737036	9/16"	1 1/8"	3-1/2"	74.72
BRT-E0737040	5/8"	1-1/4"	3-1/2"	82.94
BRT-E0737048	3/4"	1-1/2"	4"	130.16
BRT-E0737064	1"	1-1/2"	4"	204.29



BRT-TOOLS



Part No.	Mill Diameter	Shank Diameter	Length of Cut	Overall Length	Price
Uncoated					
BRT-E0828558	1/8	1/8	3/8	1-1/2	\$6.41
BRT-E0828565	3/16	3/16	9/16	2	10.23
BRT-E0828573	1/4	1/4	5/8	2-1/2	13.57
BRT-E0828579	5/16	5/16	5/8	2-1/2	21.05
BRT-E0828584	3/8	3/8	1	2-1/2	23.25
BRT-E0828588	7/16	7/16	1-1/4	2-3/4	31.19
BRT-E0828593	1/2	1/2	1-1/4	3	37.50
BRT-E0828595	5/8	5/8	1-5/8	3-1/2	71.60
BRT-E0828598	3/4	3/4	1-5/8	4	89.58
BRT-E0828600	1	1	2	5	190.96



ALU/MAX



Carbide, 3 Flute 45° Helix Regular Length

- High velocity milling of **ALUMINUM & OTHER NON-FERROUS MATERIALS**
- 3 flute and 45° helix allow harmonic balance at high speed condition and smooth cutting
- Improved surface roughness-cylindrical margin which is controlled tightly
- Maximum-metal removal rate
- Superior chip evacuation
- Mirror face-excellent surface finish



ANNULAR CUTTERS



1" Cut Depth



Part No.	Cutter Diameter	Qty.	Price
BRT-AC16311	7/16	1	\$19.84
BRT-AC16321	1/2	1	19.84
BRT-AC16331	9/16	1	22.60
BRT-AC16341	5/8	1	25.11
BRT-AC16351	11/16	1	25.11
BRT-AC16361	3/4	1	27.12
BRT-AC16371	13/16	1	30.05
BRT-AC16381	7/8	1	33.64
BRT-AC16391	15/16	1	36.32
BRT-AC16401	1 INCH	1	36.32
BRT-AC16411	1-1/16	1	41.08
BRT-AC16421	1-1/8	1	43.00
BRT-AC16431	1-3/16	1	43.83
BRT-AC16441	1-1/4	1	48.26
BRT-AC16451	1-5/16	1	50.10
BRT-AC16461	1-3/8	1	53.28

Pins: BRT-ACP13710 - PIN for 7/16"x 1" \$4.43 ea.

PRECISION TOOLS

• HIGH TUNGSTEN HSS • WELDON SHANK

Part No.	Cutter Diameter	Qty.	Price
BRT-AC16471	1-7/16	1	\$57.80
BRT-AC16481	1-1/2	1	59.30
BRT-AC16491	1-9/16	1	62.64
BRT-AC16501	1-5/8	1	65.39
BRT-AC16511	1-11/16	1	74.08
BRT-AC16521	1-3/4	1	79.69
BRT-AC16531	1-13/16	1	85.46
BRT-AC16541	1-7/8	1	90.22
BRT-AC16551	1-15/16	1	92.72
BRT-AC16561	2 INCH	1	101.25
BRT-AC16571	2-1/16	1	103.84
BRT-AC16581	2-1/8	1	109.35
BRT-AC16591	2-3/16	1	116.46
BRT-AC16601	2-1/4	1	119.21
BRT-AC16611	2-5/16	1	124.98
BRT-AC16621	2-3/8	1	128.24

Pins: BRT-ACP00902 - PIN for 1/2" & Larger x 1" \$4.43 ea.

2" Cut Depth



Part No.	Cutter Diameter	Qty.	Price
BRT-AC16312	7/16	1	\$26.45
BRT-AC16322	1/2	1	26.45
BRT-AC16332	9/16	1	28.45
BRT-AC16342	5/8	1	30.96
BRT-AC16352	11/16	1	30.96
BRT-AC16362	3/4	1	33.05
BRT-AC16372	13/16	1	37.23
BRT-AC16382	7/8	1	40.41
BRT-AC16392	15/16	1	45.84
BRT-AC16402	1 INCH	1	45.84
BRT-AC16412	1-1/16	1	49.16
BRT-AC16422	1-1/8	1	53.87
BRT-AC16432	1-3/16	1	55.87
BRT-AC16442	1-1/4	1	59.30
BRT-AC16452	1-5/16	1	61.96
BRT-AC16462	1-3/8	1	68.07

Pins: BRT-ACP13720 - PIN for 7/16"x 2" \$4.93 ea.

• HIGH TUNGSTEN HSS • WELDON SHANK

Part No.	Cutter Diameter	Qty.	Price
BRT-AC16472	1-7/16	1	\$75.42
BRT-AC16482	1-1/2	1	78.10
BRT-AC16492	1-9/16	1	84.87
BRT-AC16502	1-5/8	1	88.21
BRT-AC16512	1-11/16	1	93.55
BRT-AC16522	1-3/4	1	96.31
BRT-AC16532	1-13/16	1	104.42
BRT-AC16542	1-7/8	1	117.88
BRT-AC16552	1-15/16	1	121.22
BRT-AC16562	2 INCH	1	131.33
BRT-AC16572	2-1/16	1	134.01
BRT-AC16582	2-1/8	1	140.77
BRT-AC16592	2-3/16	1	150.88
BRT-AC16602	2-1/4	1	154.57
BRT-AC16612	2-5/16	1	162.34
BRT-AC16622	2-3/8	1	166.43

Pins: BRT-ACP00903 - PIN for 1/2" & Larger x 2" \$4.93 ea.



BORING BAR KITS - COOLANT THRU

3 PC Coolant Thru Boring Bar Kit

Bar Diameters - 1/2", 5/8", 3/4"
 (Uses CCMT 32.5_ Inserts)
 Case included

BRT-BBK3PCWO - \$149.64 (Inserts not included)
 BRT-BBK3PCWL - \$168.36 (Inserts included)



4 PC Coolant Thru Boring Bar Kit

Bar Diameters - 5/16", 3/8", 1/2", 5/8"
 (Uses CCMT 21.5_ Inserts)
 Case included

BRT-BBK4PCWO - \$174.68 (Inserts not included)
 BRT-BBK4PCWL - \$205.63 (Inserts included)





BORING BARS



BORING BAR SCLCR-02

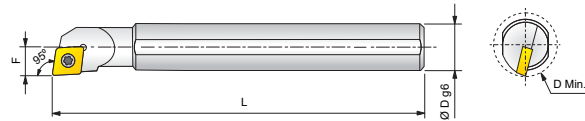

Part No.	Description	D	D Min.	F	L	Insert	Price	
BRT-BB920925	S06K SCLCR 2	0.375	0.433	0.217	4.92	CCMT 21.51	\$43.47	
BRT-BB920927	S08M SCLCR 2	0.500	0.590	0.295	5.90	CCMT 21.51	43.47	
BRT-BB920929	S10R SCLCR 2	0.625	0.708	0.354	7.87	CCMT 21.51	48.67	
BRT-BBP7003	Insert Screw for CCMT 21.51							4.35

BORING BAR SCLCR-03

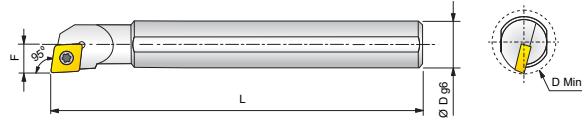

Part No.	Description	D	D Min.	F	L	Insert	Price	
BRT-BB920941	S08M SCLCR 3	0.500	0.630	0.354	5.90	CCMT 32.52	\$43.47	
BRT-BB920943	S10R SCLCR 3	0.625	0.787	0.433	7.87	CCMT 32.52	48.65	
BRT-BB920945	S12S SCLCR 3	0.750	0.925	0.511	9.84	CCMT 32.52	62.60	
BRT-BB920947	S16T SCLCR 3	1.000	1.250	0.670	11.81	CCMT 32.52	76.46	
BRT-BBP7006	Insert Screw for CCMT 32.52							4.86



PARTING TOOLS & INSERTS



ALL OUR BLADES COME WITH BRT MAX-GRIP

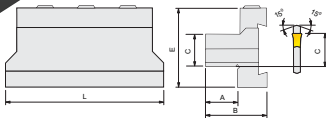
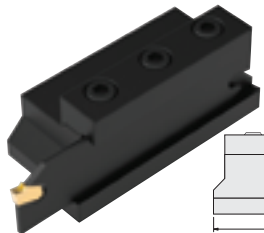

Part No.	ANSI Description	Dimensions (Inches)					Insert	Price
		H	W	T	L			
BRT-PT775035	GIH 19-2	0.750"	0.087	0.063	3.385	SGTN-2	\$46.68	
BRT-PT775042	GIH 26-2	1.020"	0.087	0.063	4.330	SGTN-2	46.68	
BRT-PT775045	GIH 26-3	1.020"	0.122	0.094	4.330	SGTN-3	46.68	
BRT-PT775050	GIH 26-4	1.020"	0.161	0.125	4.330	SGTN-4	46.68	
BRT-PT775060	GIH 32-3	1.250"	0.122	0.094	5.905	SGTN-3	50.31	
BRT-PT775065	GIH 32-4	1.250"	0.161	0.125	5.905	SGTN-4	50.31	

Part No.	ANSI Description	Dimensions (Inches)					Suitable Blade	Price
		A	B	C	E	L		
BRT-PT976035	NGTBN 0500-19	0.500	1.000	0.500	1.375	3.000	GIH 19-2	\$46.68
BRT-PT976045	NGTBN 0625-19	0.625	1.000	0.625	1.375	3.000	GIH 19-2	58.38
BRT-PT976046	NGTBN 0625-26	0.625	1.250	0.625	1.750	3.500	GIH 26-2, GIH 26-3, GIH 26-4	58.38
BRT-PT976050	NGTBN 0750-26	0.750	1.375	0.750	2.000	3.500	GIH 26-2, GIH 26-3, GIH 26-4	58.38
BRT-PT976055	NGTBN 0750-32	0.750	1.375	0.750	2.000	4.500	GIH 32-3, GIH 32-4	58.38
BRT-PT976060	NGTBN 1000-32	0.875	1.500	1.000	2.125	4.500	GIH 32-3, GIH 32-4	60.72



TINTIP DRILLS - Jobber Length



PRECISION TOOLS

• Bright Finish HSS - 135° Split Point • Tin Coating on first 1/3 of flute • Suitable for Steel, Cast Steel, Cast Iron, Stainless Steel, and Aluminum • Right hand helix



Part No.	Diameter		Flute Length	Overall Length	Price	Part No.	Diameter		Flute Length	Overall Length	Price
	Fractional	Decimal					Fractional	Decimal			
BRT-TP182004	1/16	.0625	7/8	1-7/8	\$0.50	BRT-TP182019	19/64	.2969	3-1/16	4-3/8	1.71
BRT-TP182005	5/64	.0781	1	2	0.50	BRT-TP182020	5/16	.3125	3-3/16	4-1/2	1.76
BRT-TP182006	3/32	.0938	1-1/4	2-1/4	0.50	BRT-TP182021	21/64	.3281	3-5/16	4-5/8	1.97
BRT-TP182007	7/64	.1094	1-1/2	2-5/8	0.50	BRT-TP182022	11/32	.3438	3-7/16	4-3/4	2.34
BRT-TP182008	1/8	.1250	1-5/8	2-3/4	0.50	BRT-TP182023	23/64	.3594	3-1/2	4-7/8	2.42
BRT-TP182009	9/64	.1406	1-3/4	2-7/8	0.59	BRT-TP182024	3/8	.3750	3-5/8	5	2.88
BRT-TP182010	5/32	.1563	2	3-1/8	0.59	BRT-TP182025	25/64	.3906	3-3/4	5-1/8	3.05
BRT-TP182011	11/64	.1719	2-1/8	3-1/4	0.68	BRT-TP182026	13/32	.4063	3-7/8	5-1/4	3.51
BRT-TP182012	3/16	.1875	2-5/16	3-1/2	0.80	BRT-TP182027	27/64	.4219	3-15/16	5-3/8	3.76
BRT-TP182013	13/64	.2031	2-7/16	3-5/8	0.96	BRT-TP182028	7/16	.4375	4-1/16	5-1/2	4.10
BRT-TP182014	7/32	.2188	2-1/2	3-3/4	1.04	BRT-TP182029	29/64	.4531	4-3/16	5-5/8	4.43
BRT-TP182015	15/64	.2344	2-5/8	3-7/8	1.06	BRT-TP182030	15/32	.4688	4-5/16	5-3/4	5.18
BRT-TP182016	1/4	.2500	2-3/4	4	1.17	BRT-TP182031	31/64	.4844	4-3/8	5-7/8	5.22
BRT-TP182017	17/64	.2656	2-7/8	4-1/8	1.33	BRT-TP182032	1/2	.5000	4-1/2	6	5.80
BRT-TP182018	9/32	.2813	2-15/16	4-1/4	1.59						

TINTIP SETS

Part # - BRT-TP182SET - INCH - HSS Jobber Length
• Split Point • 1/16" - 1/2" • 29 Pcs.

\$66.⁶⁹

Part # - BRT-TP65SET - METRIC - HSS Jobber Length
• Split Point • 1.0mm - 13.0mm • 25 Pcs.

\$66.⁶⁹



Parallel Shank coolant thru End Mill (APKT 1604)

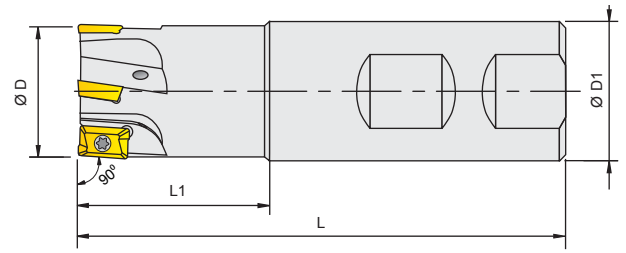
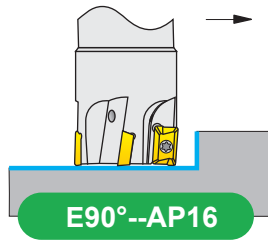

Part No.	ISO Designation	ØD	Ø D1 g7	L1	L	Z	Spare Type	Insert	Price
BRT-APE95120	E90-0.75"AP16-01FL	0.75	0.75	1.25	4.00	01	K158	APKT 1604	\$67.20
BRT-APE95126	E90-1.00"AP16-02FL	1.00	1.00	1.30	4.50	02	K158	APKT 1604	69.60
BRT-APE95133	E90-1.25"AP16-03FL	1.00	1.00	151	5.00	03	K158	APKT 1604	96.80
BRT-APE95140	E90-1.50"AP16-04FL	1.50	1.50	157	5.00	04	K158	APKT 1604	119.00



Buy any **TWO** of the ABOVE and Receive 10 **FREE!!** Inserts



90° Facing Square Shoulder Cutter coolant thru (APKT 1604)

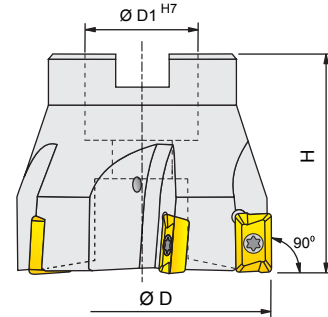
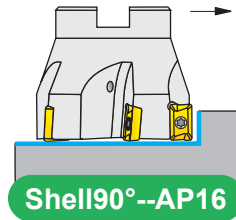
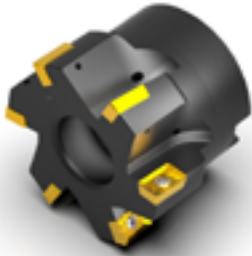

Part No.	ISO Designation	ØD	Ø D1 H7	H	Z	Spare Type	Insert	Price
BRT-APS95855	2.00"SHELL AP16-5FL-0.750"AH	2.00	0.750	1.75	05	K158	APKT 1604	\$124.00
BRT-APS95857	2.00"SHELL AP16-5FL-0.750"AH	2.50	0.750	2.00	06	K158	APKT 1604	148.00
BRT-APS95859	2.00"SHELL AP16-5FL-0.750"AH	3.00	1.000	2.00	07	K158	APKT 1604	179.20
BRT-APS95861	2.00"SHELL AP16-5FL-0.750"AH	4.00	1.500	2.00	08	K158	APKT 1604	239.00

Spare Parts

Type	Torx Screw	Description	Part No.	Price
K158	7006*Z	PVD Coated Grade for all steels, APKT 160408-GM BRT2410 (sold in Packs of 10)	BRT-AP162410	\$5.60 ea.



Buy any Above Cutter and Receive 10 **FREE!!** Inserts



APKT 160408 GM BRT2410

Excellent PVD Coated Grade for All Steels and SS

Part No. **BRT-AP162410** **\$5.60 each**

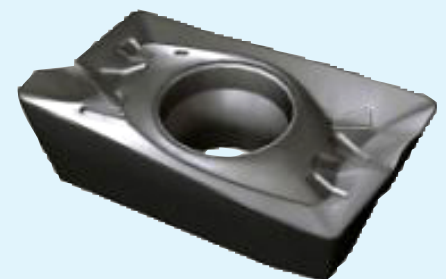



Bi-Metal Hole Saws



M42 cobalt bi-metal cutting edge provides shock resistant teeth and resists tooth stripping. 4/6 positive tooth configuration allows for fast, smooth cuts and less vibration.



Part No.	INCHES	MM	Price
BRT-63000014	9/16	14	\$2.28
BRT-63000016	5/8	16	2.61
BRT-63000017	11/16	17	2.77
BRT-63000019	3/4	19	3.10
BRT-63000020	25/32	20	3.26
BRT-63000021	13/16	21	3.42
BRT-63000022	7/8	22	3.59
BRT-63000024	15/16	24	3.91
BRT-63000025	1	25	4.08
BRT-63000027	1-1/16	27	4.40
BRT-63000029	1-1/8	29	4.73
BRT-63000030	1-3/16	30	4.89
BRT-63000032	1-1/4	32	5.22
BRT-63000033	1-5/16	33	5.38
BRT-63000035	1-3/8	35	5.71
BRT-63000037	1-7/16	37	6.03
BRT-63000038	1-1/2	38	6.20
BRT-63000040	1-9/16	40	6.52
BRT-63000041	1-5/8	41	6.68
BRT-63000043	1-11/16	43	7.01
BRT-63000044	1-3/4	44	7.17
BRT-63000046	1-13/16	46	7.50
BRT-63000048	1-7/8	48	7.83
BRT-63000051	2	51	8.32
BRT-63000052	2-1/16	52	8.48
BRT-63000054	2-1/8	54	8.80
BRT-63000057	2-1/4	57	9.29
BRT-63000059	2-5/16	59	9.62
BRT-63000060	2-3/8	60	9.78
BRT-63000064	2-1/2	64	10.44
BRT-63000065	2-9/16	65	10.60
BRT-63000067	2-5/8	67	10.92
BRT-63000068	2-11/16	68	11.09
BRT-63000070	2-3/4	70	11.41
BRT-63000073	2-7/8	73	11.90
BRT-63000076	3	76	12.39
BRT-63000079	3-1/8	79	12.88
BRT-63000083	3-1/4	83	13.53
BRT-63000086	3-3/8	86	14.02
BRT-63000089	3-1/2	89	14.51
BRT-63000092	3-5/8	92	15.00
BRT-63000095	3-3/4	95	15.49
BRT-63000098	3-7/8	98	15.98
BRT-63000102	4	102	16.63
BRT-63000105	4-1/8	105	17.12
BRT-63000108	4-1/4	108	17.61
BRT-63000111	4-3/8	111	18.10
BRT-63000114	4-1/2	114	18.59
BRT-63000121	4-3/4	121	19.73
BRT-63000127	5	127	20.71
BRT-63000133	5-1/4	133	21.69
BRT-63000140	5-1/2	140	22.83
BRT-63000146	5-3/4	146	23.81
BRT-63000152	6	152	24.78

BRT-Tools Hole Saw Accessories

Part No.	Description	Picture	Price
BRT-63010002	Arbor - 9/16" to 1-3/16" 3/8" Shank	A	\$6.42
BRT-63020007	Arbor - 1-1/4" to 6" 3/8" Shank	B	7.13
BRT-63040300	12" Extension	C	10.39
BRT-63060082	3-1/4" x 1/4" Pilot Drill	D	2.22



C - 12" Extension for Round and Hex Shanks

GRATTEC

manufactured by NOGA

interchangeable with Shaviv

GT Countersink

For deburring and countersinking. Most useful for deep holes.

Includes:

- Blade Holder *EL0300GT*. Holds all "C" Countersinks.
- H.S.S. Ø 20mm, *GT-C20*, HSS Countersink.
- Universal Handle *EL1000GT*.



Part No. EL1300GT
Sale Price \$24.20

GT "B" Set

Most universal set. Accepts all "B" types blades.

Includes:

- Blade Holder *EL0100GT* which telescopes from 6-125mm. Holds all "B" (Ø2.6mm) blades
- One each *GT-B10* and *GT-B20* HSS blade inside the Handle.
- Universal Handle *EL1000GT* which can store spare blades.



Part No. EL1100GT
Sale Price \$10.10

GT "E" Set

Similar to the GT "B" set but takes the heavy-duty "E" (Ø3.2mm) blades.

Includes:

- Blade Holder *EL0200GT* which telescopes from 6-125mm. Holds all "E" (3.2mm) blades
- One each *GT-E100*, *GT-E200*, *GT-E300* blade.
- Universal Handle *EL1000GT* which can store spare blades.



Part No. EL1200GT
Sale Price \$12.24

GT Internal Scraper

For deburring cross holes.

Includes:

- Blade Holder *EL0500GT*. An M3 set screw is holding the blade.
- 45° HSS scraper *GT-D66* blade.
- Universal Handle *EL1000GT*.



Part No. EL1501GT
Sale Price \$12.53

Grat-Tec Double-Burr

Most useful for deburring sheet metal. Simultaneously removes burrs from both sides of sheet metal. Range 0-12mm.

Includes:

- Handle with special hand guard.
- 2 pcs. HSS round blades *GT-N80*.



Part No. DB2000GT
Sale Price \$19.14

Grat-Tec RotoDrive "GT-U"

Patented

For fast effective chamfering and countersinking.

Includes:

- New non-telescoping Handle with steel bushing. *EL2100GT*.
- RotoDrive Ø16.5mm HSS Countersink, *GT-BC1650*.



Part No. EL6500GT
Sale Price \$15.96

Rapid-Burr

Slim grip Aluminum Handle with one replaceable blade, *GT-E100*.

Includes:

- 12mm Hexagonal painted handle. Holds all Ø3.2mm "E" type blades.
- One HSS blade *GT-E100*.



Part No. RB1000GT
Sale Price \$6.44

Plastic Edge-Off

Most competitive tool. The blade is replaceable.

Includes:

- 8mm Hexagonal plastic handle with pocket clip.
- One HSS Blade *GT-E100*.



Part No. E02000GT
Sale Price \$2.32

RotoDrive Countersink

The quickest way to chamfer by hand.

Includes:

- Grattec Burr Handle *NB1000GT*.
- RotoDrive Countersink *GT-BC1040*.
- Range: 0-10.4mm



Part No. RD1040GT
Sale Price \$16.60

External Countersink

Chamfers the O.D. on bars and tubes range 4-18mm

Includes:

- Grattec Burr Handle *NB1000GT*.
- External RotoDrive HSS countersink *GT-EX2000*.
- Range: 4-18mm



Part No. RD4000GT
Sale Price \$15.80

Large Reversible Countersink

Patented

For deburring both back side and front side of holes.

Includes:

- Steel handle and blade *GT-BR2200*.
- Range: 10-22mm.



Part No. RC2200GT
Sale Price \$28.08

Reversible Countersink

Patented

For deburring both back side and front side of holes.

Includes:

- Steel handle and blade *GT-BR2000*.
- Range: 5.5-10mm.



Part No. RC2000GT
Sale Price \$22.31

Mini Reversible Countersink

Patented

For deburring both back side and front side of holes.

Includes:

- Steel handle and small blade *GT-BR1000*.
- Range: 3-5.5mm.



Part No. RC1000GT
Sale Price \$21.06

Mini RotoDrive Countersink

Deburs and countersinks small holes 0-3.0 mm diameter.



Part No. FT1200GT
Sale Price \$6.60

Mini Scraper

Fine triangular HSS mini-scraper ideal for Tool and Die Maker.



Part No. FT1100GT
Sale Price \$7.44

Mini Universal Deburring Tool









A tool with finest HSS blade *GT-E150* for extra fine jobs.







Part No. FT1000GT
Sale Price \$3.17

GRATTEC

Countersinks

GT-C12 \$13.82		HSS Ø12 mm 90° two flutes countersink
GT-C20 \$16.31		HSS Ø20 mm 90° two flutes countersink
GT-C30 \$26.20		HSS Ø30 mm 90° two flutes countersink
GT-BC8300 \$12.73		Patented cranked HSS RotoDrive countersink 0-8.3mm.
GT-BC1650 \$15.58		Patented cranked HSS RotoDrive countersink 0-16.5mm.
GT-EX2000 \$11.56		Patented cranked HSS external countersink 4-18mm.
GT-BR2200 \$11.24		For cross holes 10-22mm. HSS Blade for RC2200GT
GT-BR2000 \$11.24		For cross holes 5.5-10mm. HSS Blade for RC2000GT
GT-BR1000 \$9.61		For cross holes 3-5.5mm. HSS Blade for RC1000GT

Scrapers

GT-D50 \$6.31		HSS Hollow ground mini scraper 3.2 x 50mm. For very fine jobs. Used with D Holder EL0500GT.
GT-D55 \$9.07		Solid carbide GT-D55
GT-T60 \$7.82		7 x 60mm HSS triangular scraper used with T Holder EL0602GT
GT-D66 \$4.10		3.2 x 50mm 45° H.S.S. internal scraper for cross holes. Used with D Holder EL0500GT.
GT-D77 \$5.22		Similar to D66 but 75mm long. Used with D Holder EL0500GT

Convexed Cera-Cut



Part No. CR2000GT
Price \$24.21

Ideal for all plastic materials. Suitable for surface scraping and parting line deflashing. Blade can be replaced. Includes: Cera-Cut handle and ceramic blade with radius R=250mm.

Optional Blade Part No. GT-CR2200 Price \$19.73

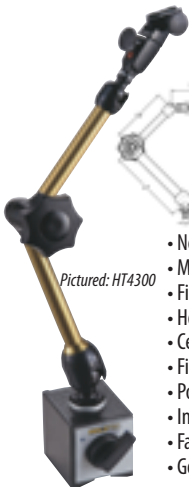

























HOLDTEC MagBases

Tired of buying Mag Bases every year? Why Not Buy Quality?!!

- New articulated holder for a wide range of applications.
- Modular holder. Choose the arms that fit your needs.
- Fine adjustment on top with universal swivel clamp.
- Holds 6mm, 8mm, 3/8" and dovetail.
- Central locking mechanism with HOLDTEC designed spring loaded bearing.
- Five Axis holder.
- Powerful on/off magnetic base.
- Instant fixation at any position.
- Fast and easy to set up gauges into required position.
- Gold finished arms.

Bottom Order No.	Holder Bottom Thread	Weight Kg	Arm Length			Total L1+L2+L3	Force N	Magnet Dimension			Sale Price
			Bottom L1	Top L2	Arm L3			W	L	H	
HT2100	Ext. M5	0.430	80	50	201	320	30	40	35	\$80.22	
HT3200	Ext. M8	1.245	110	80	261	800	50	60	55	105.81	
HT4300	Ext. M8	1.420	140	110	321	800	50	60	55	133.89	

Swivel Blades

GT-B10 \$0.83		HSS blade light duty for steel, aluminum & plastic
GT-B10L \$2.00		B10 for left handed user
GT-B10S \$1.24		Super hard B10 Cobalt (M35) Blade for stainless steel & plastics
GT-B10TIN \$1.66		B10 Tin coated for long life
GT-B10C \$3.85		Solid carbide B10 blade for hardened steel & plastic
GT-B20 \$0.83		HSS blade light duty for brass & cast iron. For both right & left hand users.
GT-B20C \$4.14		Solid carbide B20 blade for hardened steel & hard plastics
GT-B30 \$1.76		HSS blade removes internal & external burrs simultaneously from holes drilled into tubing & sheet metal
GT-E100 \$1.24		HSS blade heavy duty for steel, aluminum & plastic
GT-E100L \$1.16		E100 for left handed users
GT-E100TIN \$1.66		E100 Tin coated for longer life
GT-E100C \$5.80		Solid carbide E100 blade for hardened steel & plastics
GT-E100S \$1.45		Super hard E100 cobalt (M35) Blade for stainless steel & plastics
GT-E101 \$1.43		H.S.S. blade with heavy duty shank & fine cutting edge for steel & aluminum
GT-E101L \$2.29		E101 for left handed users
GT-E101TIN \$3.38		E101 Tin coated for long life
GT-E150 \$1.24		HSS blade heavy duty shank for holes as small as 1.5 mm dia.
GT-E200 \$1.24		HSS blade heavy duty for brass & cast iron. For both right & left handed users
GT-E200C \$7.32		Solid carbide E200 blade for hardened materials & plastics
GT-E202 \$1.24		HSS blade heavy duty shank. Fine cutting edge for brass & cast iron
GT-E300 \$1.42		HSS blade removes internal & external burrs simultaneously from holes drilled into tubing & sheet metal
GT-E350 \$1.42		HSS blade. Heavy duty for straight lines
GT-E600 \$2.42		HSS blade. Heavy duty for cross holes in difficult to reach places
GT-BC1000 \$5.10		Patented HSS blade. For deburring and cleaning internal threads above 9mm dia.
GT-BO1000 \$7.61		Patented HSS blade for deburring "O" Ring grooves up to 3mm width.

GRATTEC

blades are manufactured by NOGA and interchangeable with Shaviv



BRT Tools Soft Jaws - 1.5mmX60° Semi Point

For Kitagawa, Matsumoto, Howa & Seiki, Samchully, Strong, SMW



Part No.	Chuck Size	Length	Width	Groove Width	Height	Sale Price (set of 3)
BRT-SJ0636SP	6"	73	31	12	36	\$27.41
BRT-SJ0837SP	8"	95	35	14	37	30.84
BRT-SJ1042SP	10"	110	40	16	42	41.70
BRT-SJ1248SP	12"	129	48	21	48	71.50

TAIKI® Soft Jaws - 1.5mmX60° Standard Type



For Flat Type Jaws, please add "A" to suffix of order number, such as: SJ08037A, 120° Pointed: SJ08037C.

Order Number set of 3	Dimension (MM)										Sale Price (set of 3)
	S-1	S-2	S-3	S-4	S-5	S-6	S-7	S-8	S-9		
SJ06030A (6")	73	31	30	12	5	18	20	38	M10	\$28.49	
SJ06030C (6")	73	31	30	12	5	18	20	38	M10	35.84	
SJ08037A (8")	95	35	37	14	5	22	25	46	M12	35.84	
SJ08037C (8")	95	35	37	14	5	22	25	46	M12	47.54	
SJ10042A (10")	110	40	42	16	5	27	30	50	M12	49.20	
SJ10042C (10")	110	40	42	16	5	27	30	50	M12	53.29	
SJ12048A (12")	129	48	48	21	5	28	30	60	M16	81.03	
SJ12048C (12")	129	48	48	21	5	28	30	60	M16	91.06	

• Material: Steel (S45C) • Complete range of Jaws are available for Kitagawa style chucks

TAIKI® Jaw Nuts

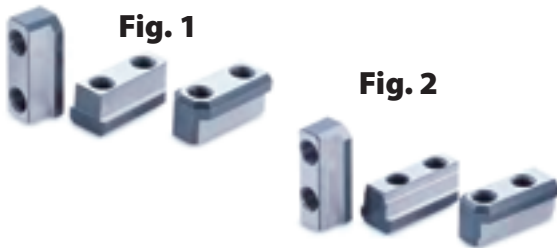
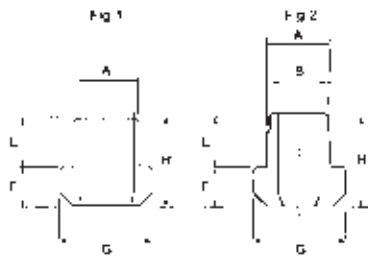

Standard T-Nuts to suit Kitagawa B-Type, Matsumoto, Howa		Dimensions (UNIT: mm)									
Order Number/ Chuck	To suit	Reference	Set of 3 Price								
Dimension	Size	Kitagawa	A	C	D	E	F	G	H	Drawing	Price
TB06	6"	B-06	12	20	M10	15	7	17.5	22	Fig. 1	\$60.71
TB08	8"	B-08	14	25	M12	16	10	20.5	26	Fig. 1	69.08
TB10	10"	B-10	16	30	M12	16	10	22.5	26	Fig. 1	77.68
TB12	12"	B-12	18	30	M14	20	13.5	26.5	33.5	Fig. 1	102.16
TB15	15"	N-15/B215	25.5	43	M20	20	19	35	39	Fig. 1	184.58

Standard T-Nuts to suit Kitagawa B-200 Type		Reference Set of 3 Price										
Order Number/ Chuck	To suit	Reference	Price									
Dimension	Size	Kitagawa	A	B	C	D	E	F	G	H	Drawing	Price
T05	5"	B-205	10	-	14	M8	9.5	5	14	14.5	Fig. 1	\$56.41
T06	6"	B-206	12	-	20	M10	11	7.5	17.5	18.5	Fig. 1	60.71
T08	8"	B-208	14	-	25	M12	12	8.5	20.5	20.5	Fig. 1	69.08
T10	10"	B-210	16	-	30	M12	13	8.5	22.5	21.5	Fig. 1	77.68
T12	12"	B-212	21	-	30	M16	16.5	11.5	28	28	Fig. 1	102.16
T15	15"	B-15	24	22	43	M20	29	16.5	33.5	45.5	Fig. 2	184.58

TAIKI® Hard Jaws

The hardened serrations of the clamping step are designed to clamp the workpiece securely without leaving large scrape.

• Material: SNCM21 • To suit kitagawa and other power chucks

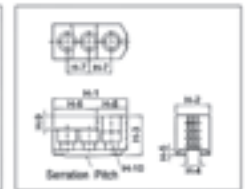
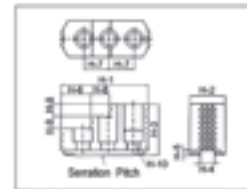

Order Number/ Dimension	Chuck Size	Dimensions (UNIT: mm) set of 3										Serration	Reference Pitch	Drawing	Price
		H-1	H-2	H-3	H-4	H-5	H-6	H-7	H-8	H-9	H-10				
HJ06	6"	67	31	36	12	5	39	20	28	12	M10	1.5x60°	Fig. 2	\$291.67	
HJ08	8"	86	35	51	14	5	31	25	18	12	M12	1.5x60°	Fig. 1	321.75	
HJ10	10"	100	40	54	16	5	43	30	17	14	M12	1.5x60°	Fig. 1	391.95	
HJ12-21	12"	113	50	52	21	5	69.5	30	43.5	20	M16	1.5x60°	Fig. 2	562.43	
HJ15/18-22	15"/18"	143	62	86	22	8/5	55	43	38	20	M20	1.5x60°	Fig. 1	751.30	
HJ15/18-25.5	15"/18"	143	62	86	25.5	8/5	55	43	38	20	M20	1.5x60°	Fig. 1	751.30	



BRT-Tools Hard Jaws

Order Number/ Dimension	Chuck Size	Dimensions (UNIT: mm) set of 3										Serration	Drawing	Price
		H-1	H-2	H-3	H-4	H-5	H-6	H-7	H-8	H-9	H-10			
BRT-HJ06	6"	67	31	36	12	5	39	20	28	12	M10	Fig. 2	\$207.20	
BRT-HJ08	8"	86	35	51	14	5	31	25	18	12	M12	Fig. 1	279.20	
BRT-HJ10	10"	100	40	54	16	5	43	30	17	14	M12	Fig. 1	317.60	





These split Type B Bushings are manufactured for all types and sizes of CNC Lathes and Chuckers; are Heat Treated and precision ground concentric. They are used to adapt Drills, Boring Bars, and other Shank Tools.

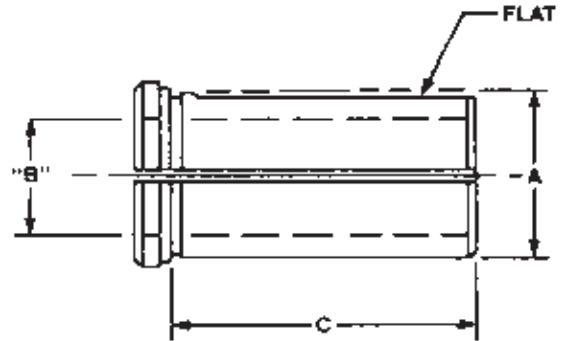

PART NO.	DESCRIPTION	O.D. - "A"	I.D. - "B"	LENGTH - "C"	PRICE
BRT-20010725	Bushing Type B	3/4"	1/4"	1-1/2"	\$29.17
BRT-20010731	Bushing Type B	3/4"	5/16"	1-1/2"	29.17
BRT-20010737	Bushing Type B	3/4"	3/8"	1-1/2"	29.17
BRT-20010750	Bushing Type B	3/4"	1/2"	1-1/2"	29.17
BRT-20011031	Bushing Type B	1"	5/16"	1-3/4"	29.17
BRT-20011037	Bushing Type B	1"	3/8"	1-3/4"	29.17
BRT-20011050	Bushing Type B	1"	1/2"	1-3/4"	29.17
BRT-20011062	Bushing Type B	1"	5/8"	1-3/4"	29.17
BRT-20011075	Bushing Type B	1"	3/4"	1-3/4"	29.17
BRT-20011237	Bushing Type B	1-1/4"	3/8"	2-1/8"	30.08
BRT-20011250	Bushing Type B	1-1/4"	1/2"	2-1/8"	30.08
BRT-20011262	Bushing Type B	1-1/4"	5/8"	2-1/8"	30.08
BRT-20011275	Bushing Type B	1-1/4"	3/4"	2-1/8"	30.08
BRT-20011287	Bushing Type B	1-1/4"	7/8"	2-1/8"	30.08
BRT-20011291	Bushing Type B	1-1/4"	1"	2-1/8"	30.08
BRT-20011537	Bushing Type B	1-1/2"	3/8"	2-1/2"	31.34
BRT-20011550	Bushing Type B	1-1/2"	1/2"	2-1/2"	31.34
BRT-20011562	Bushing Type B	1-1/2"	5/8"	2-1/2"	31.34
BRT-20011575	Bushing Type B	1-1/2"	3/4"	2-1/2"	31.34
BRT-20011587	Bushing Type B	1-1/2"	7/8"	2-1/2"	31.34
BRT-20011591	Bushing Type B	1-1/2"	1"	2-1/2"	31.34
BRT-20011592	Bushing Type B	1-1/2"	1-1/4"	2-1/2"	31.34
BRT-20011750	Bushing Type B	1-3/4"	1/2"	3"	35.85
BRT-20011762	Bushing Type B	1-3/4"	5/8"	3"	35.85
BRT-20011775	Bushing Type B	1-3/4"	3/4"	3"	35.85
BRT-20011787	Bushing Type B	1-3/4"	7/8"	3"	35.85
BRT-20011791	Bushing Type B	1-3/4"	1"	3"	35.85
BRT-20011792	Bushing Type B	1-3/4"	1-1/4"	3"	35.85
BRT-20011793	Bushing Type B	1-3/4"	1-1/2"	3"	35.85
BRT-20012050	Bushing Type B	2"	1/2"	3-1/2"	40.95
BRT-20012062	Bushing Type B	2"	5/8"	3-1/2"	40.95
BRT-20012075	Bushing Type B	2"	3/4"	3-1/2"	40.95
BRT-20012091	Bushing Type B	2"	1"	3-1/2"	40.95
BRT-20012092	Bushing Type B	2"	1-1/4"	3-1/2"	40.95
BRT-20012094	Bushing Type B	2"	1-1/2"	3-1/2"	40.95
BRT-20012095	Bushing Type B	2"	1-3/4"	3-1/2"	40.95



This CNC Type C Bushing is designed for use on all CNC turning machines. To adapt a wide variety of Boring Bars, Drills, Reamers and Shank Type tools. Precision machine hardened and ground.

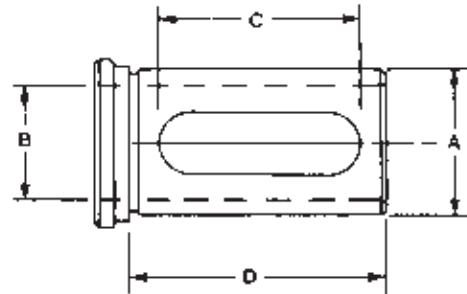

PART NO.	DESCRIPTION	O.D. - "A"	I.D. - "B"	LENGTH - "D"	SLOT - "C"	PRICE
BRT-20020725	Bushing Type C	3/4"	1/4"	2"	1-1/2"	\$29.17
BRT-20020731	Bushing Type C	3/4"	5/16"	2"	1-1/2"	29.17
BRT-20020737	Bushing Type C	3/4"	3/8"	2"	1-1/2"	29.17
BRT-20020750	Bushing Type C	3/4"	1/2"	2"	1-1/2"	29.17
BRT-20021031	Bushing Type C	1"	5/16"	2-3/4"	2-3/8"	29.17
BRT-20021037	Bushing Type C	1"	3/8"	2-3/4"	2-3/8"	29.17
BRT-20021050	Bushing Type C	1"	1/2"	2-3/4"	2-3/8"	29.17
BRT-20021062	Bushing Type C	1"	5/8"	2-3/4"	2-3/8"	29.17
BRT-20021075	Bushing Type C	1"	3/4"	2-3/4"	2-3/8"	29.17
BRT-20021237	Bushing Type C	1-1/4"	3/8"	3-1/4"	2-3/4"	30.08
BRT-20021250	Bushing Type C	1-1/4"	1/2"	3-1/4"	2-3/4"	30.08
BRT-20021262	Bushing Type C	1-1/4"	5/8"	3-1/4"	2-3/4"	30.08
BRT-20021275	Bushing Type C	1-1/4"	3/4"	3-1/4"	2-3/4"	30.08
BRT-20021287	Bushing Type C	1-1/4"	7/8"	3-1/4"	2-3/4"	30.08
BRT-20021291	Bushing Type C	1-1/4"	1"	3-1/4"	2-3/4"	30.08
BRT-20021537	Bushing Type C	1-1/2"	3/8"	3-3/8"	3"	31.34
BRT-20021550	Bushing Type C	1-1/2"	1/2"	3-3/8"	3"	31.34
BRT-20021562	Bushing Type C	1-1/2"	5/8"	3-3/8"	3"	31.34
BRT-20021575	Bushing Type C	1-1/2"	3/4"	3-3/8"	3"	31.34
BRT-20021587	Bushing Type C	1-1/2"	7/8"	3-3/8"	3"	31.34
BRT-20021591	Bushing Type C	1-1/2"	1"	3-3/8"	3"	31.34
BRT-20021592	Bushing Type C	1-1/2"	1-1/4"	3-3/8"	3"	31.34
BRT-20021750	Bushing Type C	1-3/4"	1/2"	3-1/2"	3-1/8"	35.85
BRT-20021762	Bushing Type C	1-3/4"	5/8"	3-1/2"	3-1/8"	35.85
BRT-20021775	Bushing Type C	1-3/4"	3/4"	3-1/2"	3-1/8"	35.85
BRT-20021787	Bushing Type C	1-3/4"	7/8"	3-1/2"	3-1/8"	35.85
BRT-20021791	Bushing Type C	1-3/4"	1"	3-1/2"	3-1/8"	35.85
BRT-20021792	Bushing Type C	1-3/4"	1-1/4"	3-1/2"	3-1/8"	35.85
BRT-20021793	Bushing Type C	1-3/4"	1-1/2"	3-1/2"	3-1/8"	40.95
BRT-20022050	Bushing Type C	2"	1/2"	4"	3-5/8"	40.95
BRT-20022062	Bushing Type C	2"	5/8"	4"	3-5/8"	40.95
BRT-20022075	Bushing Type C	2"	3/4"	4"	3-5/8"	40.95
BRT-20022091	Bushing Type C	2"	1"	4"	3-5/8"	40.95
BRT-20022092	Bushing Type C	2"	1-1/4"	4"	3-5/8"	40.95
BRT-20022094	Bushing Type C	2"	1-1/2"	4"	3-5/8"	40.95
BRT-20022095	Bushing Type C	2"	1-3/4"	4"	3-5/8"	40.95

DISTRIBUTED BY: